



# PACTIV

Foodservice / Food Packaging

# Product Catalog

*Application Based*



# Pactiv North American Manufacturing Locations

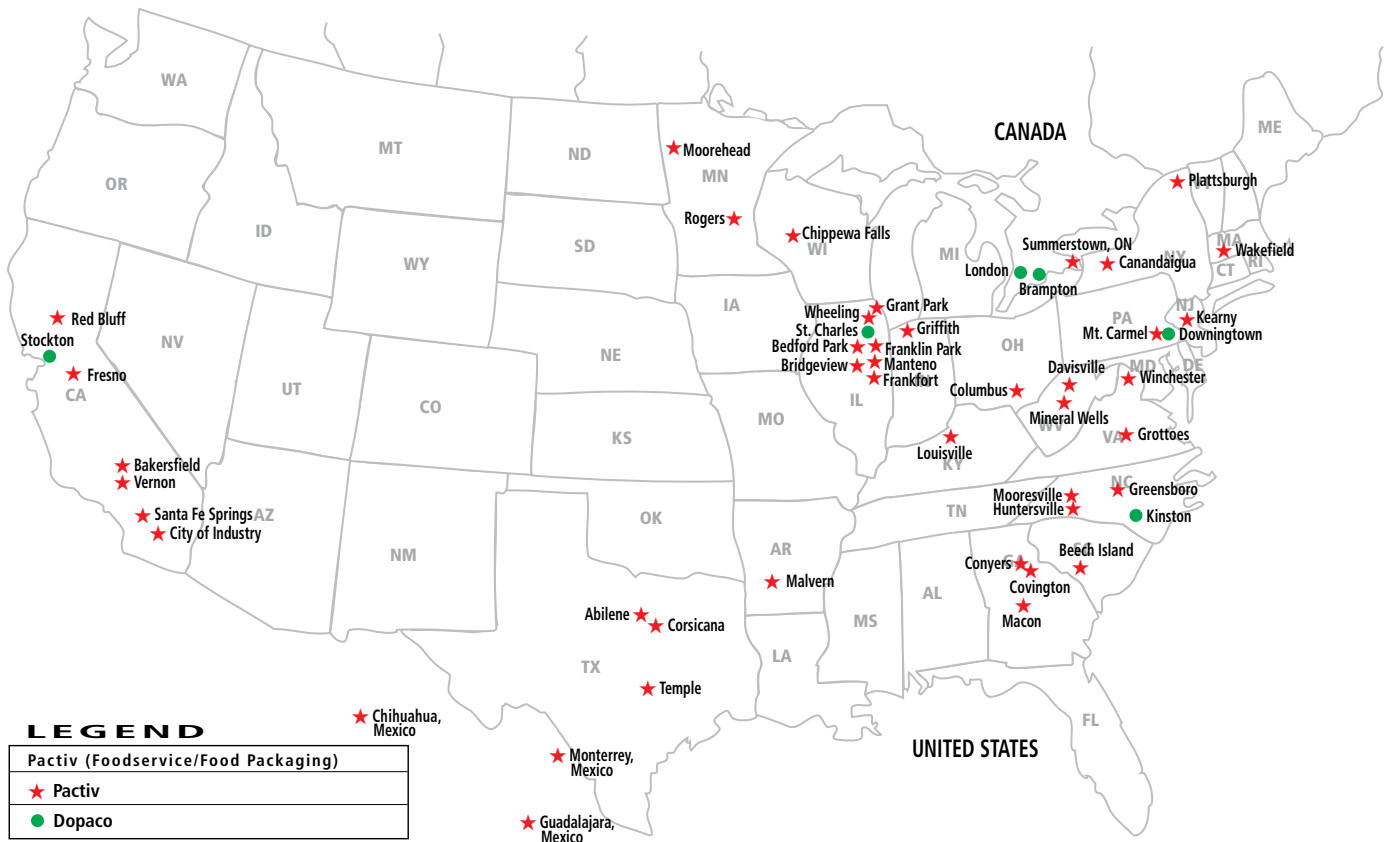

# Pactiv North American Distribution Centers

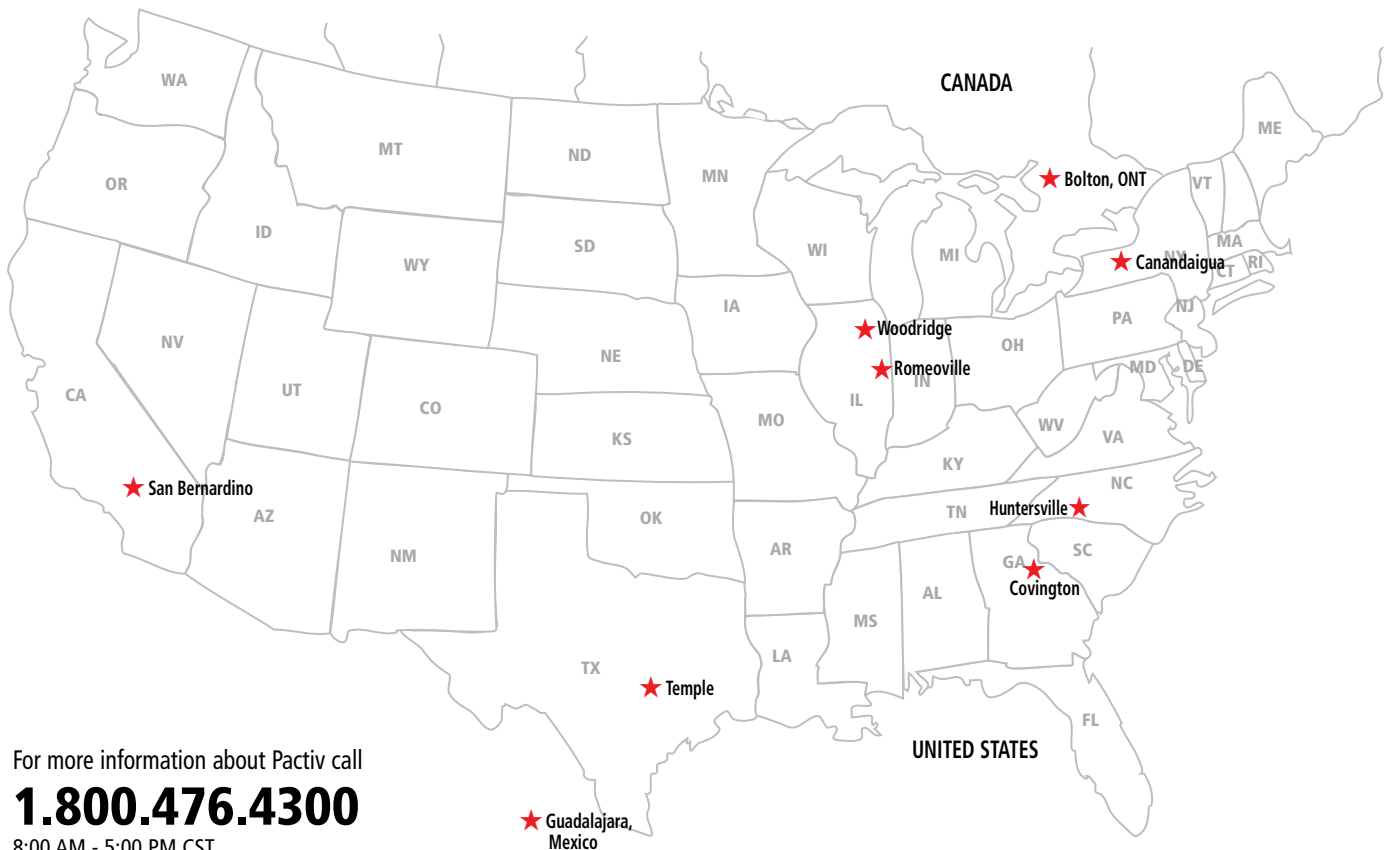

For more information about Pactiv call  
**1.800.476.4300**

8:00 AM - 5:00 PM CST.

1900 West Field Court, Lake Forest, IL 60045

© Pactiv LLC



# *Pactiv Product Catalog Index*



***Bakery Packaging***  
***Pages A-2 – A-37***



***HMR Packaging***  
***Pages F-2 – F-15***



***Beverage Packaging***  
***Pages B-2 – B-13***



***Processor Packaging***  
***Pages G-2 – G-21***



***Catering Products***  
***Pages C-2 – C-13***



***Tableware Products***  
***Pages H-2 – H-21***



***Deli Packaging***  
***Pages D-2 – D-27***



***Take-Out Packaging***  
***Pages I-2 – I-21***

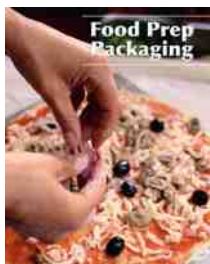

***Food Prep***  
***Pages E-2 – E-9***

# Pactiv Product Value Streams

FOAM

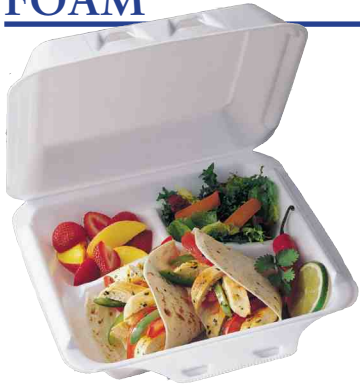

PAPER



ALUMINUM/FILM



CUPS/STRAWS



APET



OPS/PP SHEET



MOLDED FIBER



ENVIRONMENTAL



INJECTION MOLDING



## Value Stream Model

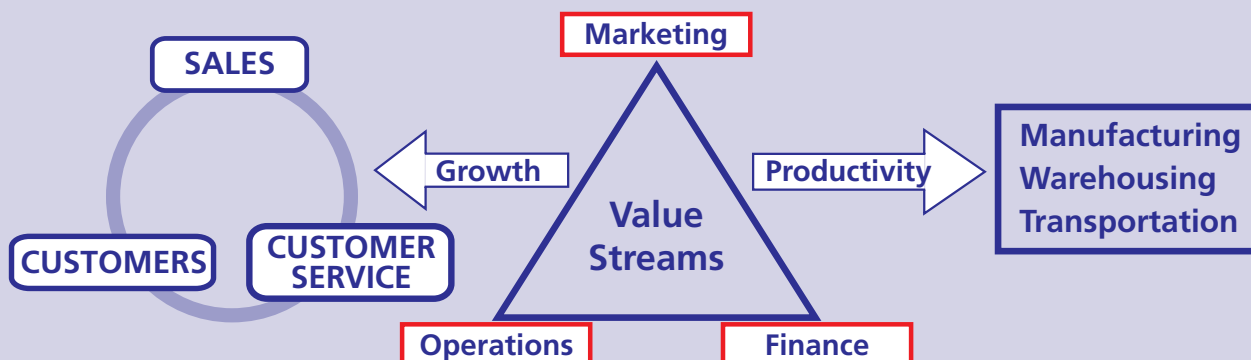

# Literature Resource Guide

## Aluminum/Film Products



Aluminum Steamtable Pan  
Y6132L & Y6050H  
9-245IH

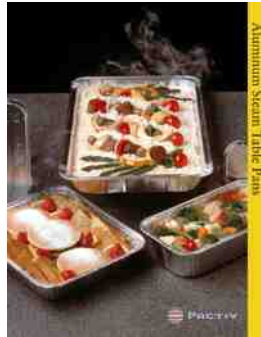

Aluminum Steamtable Pans  
9-248MG

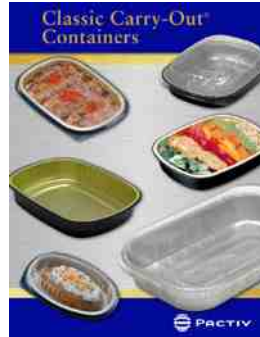

Classic Carry-Out Containers  
10-290MG

## APET Products



APET Cake Packaging  
7-203CC



APET Confectionery  
7-206CC



APET Pie Packaging  
7-202CC



APET Blueberry Packaging  
10-293IH



APET Hinged Lid Container  
6-186MG



APET SmartLock® Hinged Lid Containers  
10-274IH



APET ClearView™ Hinged Lid Containers  
11-320IH



APET Cups & Lids  
9-255MG



PWP APET Square Salad Containers  
10-287IH

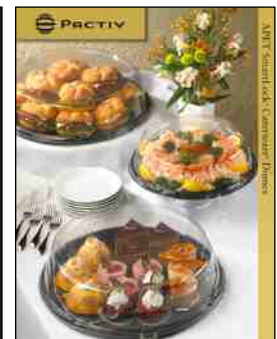

APET Caterware® Domes  
8-234CC



APET Clear Advantage™  
Smoothwall Hinged Containers  
10-283IH



PWP SmartLock® Cupcake Hingeware  
11-312IH



PWP SmartLock® Cupcake Hingeware  
8/11 TR PCR-2A

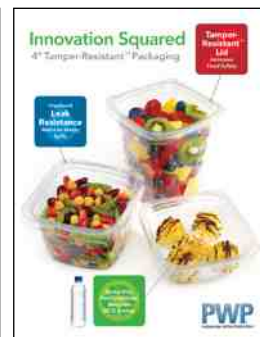

PWP Tamper Resistant Packaging  
8/11 TR PCR-2B

# Foam Products



Foam Hinged Lid Containers  
11-308IH

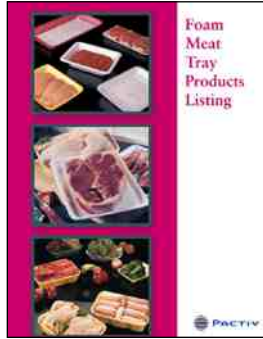

Foam Meat Trays  
7-187CC



SmartLock® Vented Foam Hinge  
8-226CC



Conventional Foam Hingeware  
9-243MG



SmartLock® Black Foam Hinge  
6-175CC



Placemaker Deluxe Laminated  
Tableware  
6-177CC



Foam Hot Cups  
9-240MG

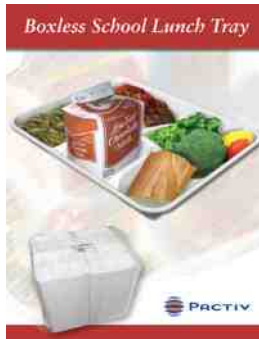

Boxless School Lunch Tray  
10-286IH



Foam Carry Trays  
11-311IH



Placemaker® Disposable Tableware  
12-338IH

# Molded Fiber Products



Molded Fiber Products  
10-295MG

# Injection Molding

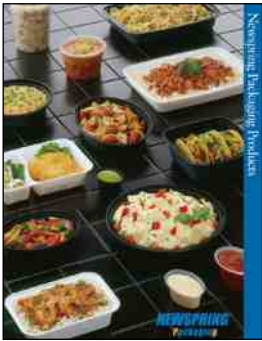

Newspring Packaging  
11-324IH



Newspring® Asian Applications  
9-264CC



Newspring® Hispanic Applications  
9-265CC



Newspring® Italian Applications  
9-266CC

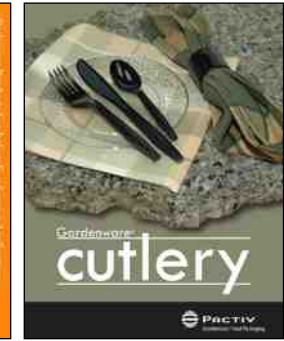

Gardenware® Cutlery  
11-326IH

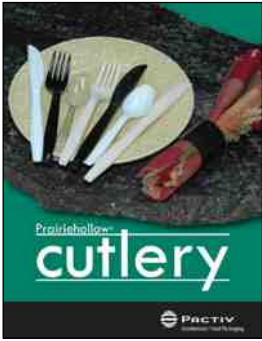

Prairiehollow® Cutlery  
11-327IH

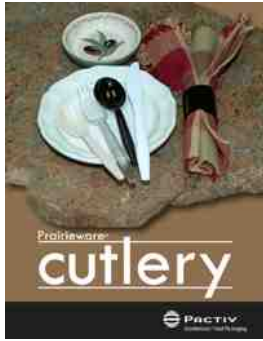

Prairieware® Cutlery  
11-328IH

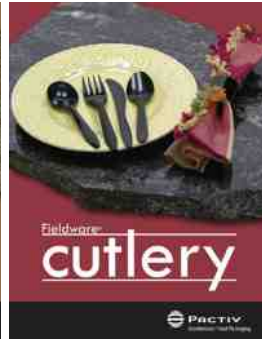

Fieldware® Cutlery  
11-329IH

# OPS/PP Products

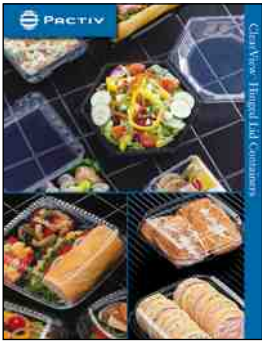

ClearView™ Hinged Lids  
10-270MG



ClearView™ SmartLock® Hotdog  
9-254IH

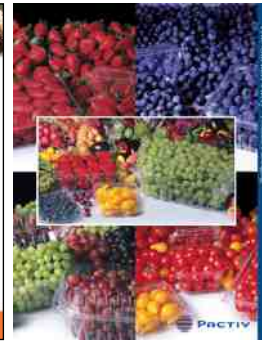

The Garden Party®  
10-292IH



ClearView™ SmartLock® Dual Color  
7-191BL

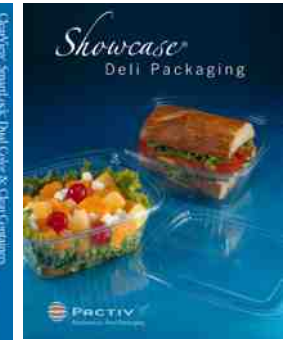

Showcase® Deli Packaging  
11-325IH

# Cups/Straws Products



Advance™ Car Cups  
11-319MG

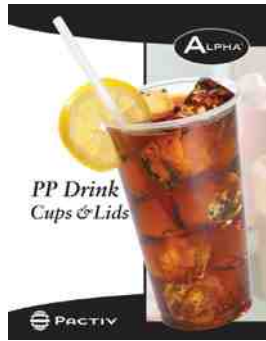

PP Drink Cups  
9-256CC



Portion Cups & Lids  
9-258MG



Translucent Drink Cups  
9-241CC

# Paper Products



Pressware® Pizza Packaging  
Solutions  
7-194MG



Pressware® Foodservice Applications  
1-056CC



Pressware® Green  
9-263IH



Pressware® Pizza Trays  
8-218CC

# Environmental Products

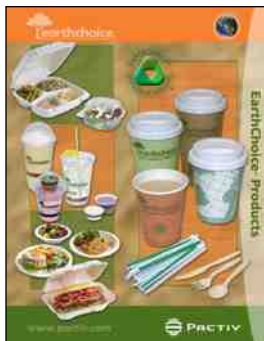

EarthChoice® Products  
1-056CC



Polystyrene Facts  
8-232CC



# Perfect Cube & Temperature Range Chart

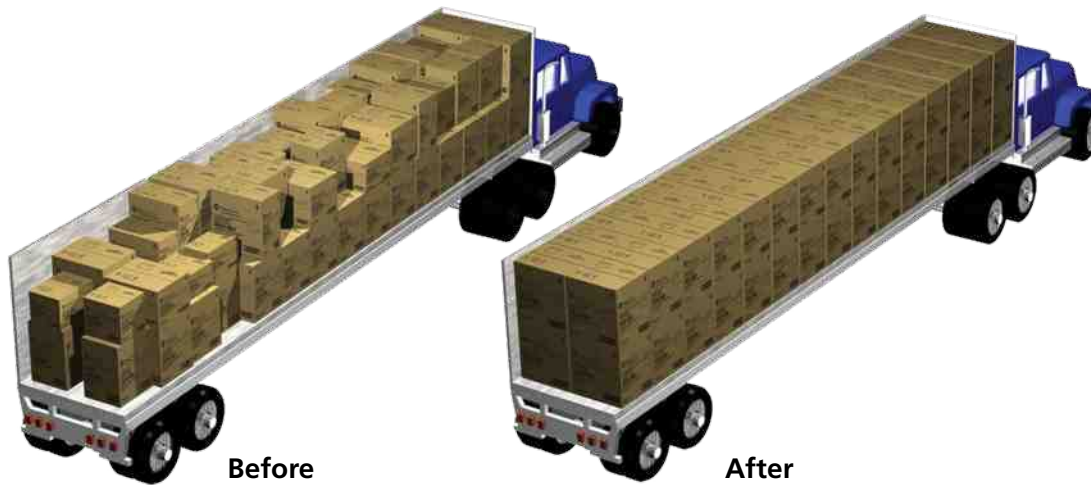

## What is Perfect Cube?

Pactiv has embarked on the Perfect Cube initiative to reconfigure all products to fit into a GMA pallet specification of 40" x 48" x 50". Pactiv customers will see faster unloading, reductions in driver retentions, labor productivity savings, improved warehouse storage, and a reduction in shortages or damaged goods.

### What might be different?

- Product piece counts per case\*
- Case dimensions\*
- Orders will need to be placed in unit quantities\*

\* Please note that not all items in this catalog have been reviewed for Perfect Cube. More items were still being reviewed by the time of publication. Any changes will be included in the next catalog edition. Please contact your Pactiv Sales Representative or Customer Service Representative for more details.

## Recommended Temperature Range Chart For All Material Types

	- 40°F / -40°C <span style="float: right;">400°F / 204°C</span>						
	Blast Freezer	Freezer	Chilled Refrigerated	Room Temperature Display	Heated Display	Microwave	Oven
PP	0°F / -18°C						250°F / 121°C
Aluminum	-20°F / -29°C						400°F / 204°C
Pressware	-40°F / -40°C						400°F / 204°C
OPS	20°F / -7°C					180°F / 82°C	
PS Foam	0°F / -18°C					150°F / 66°C	
PET	-20°F / -29°C					120°F / 49°C	
HIPS	0°F / -18°C					180°F / 82°C	
DLPS	0°F / -18°C					180°F / 82°C	
OneCup	0°F / -18°C					180°F / 82°C	
Molded Fiber	Freezer						Microwave Reheating

These guidelines are supplied to assist you in determining the proper use of Pactiv products. They are based upon testing and published guidelines and are reliable in most applications. However, because every food supplier's recipes, ingredients, processes and supply chain is unique, these guidelines are not a substitute for product testing. Confirmation of product acceptability under your specific conditions of use must be done by you.

# Custom Branding Capabilities

**FOAM CUSTOM  
EMBOSSING**



**CLEAR HINGE  
EMBOSSING**



**PRESSWARE  
CUSTOM PRINTING**



**NEWSPRINT DRY  
OFFSET PRINTING**



**DOPACO COLD/HOT  
CUP PRINTING**



**COLD CUP  
PLASTIC PRINTING**



Please contact your local Pactiv Sales Representative for order minimum and lead time.

# Pactiv's Environmental Sustainability Snapshot

**Vision** – Minimize Impacts | Offer Customer Choice | Provide Honest & Accurate Information

**Priorities** – Operations | Products | Post-Consumer Use

## Operations

### Materials Management

- Develop new processes and sources that allow us to use fewer or alternative materials.
- Offer products that include material made from plants, sugar cane, bamboo, corn, pulp fiber and other renewable and sustainable resources.
- Process recycled PETE at our in-house recycling center in West Virginia.

### Energy Efficiency

- Use energy as efficiently as possible and reduce our overall consumption.
- Turn it off, turn it down, or re-engineer a process to conserve energy.
- Use variable speed motors and drives to improve operational control of pumps, blowers, air compressors, fans, and extruder motors.
- Converted facilities to more energy-efficient lighting.

### Reduce and Reuse Waste

- Recycle the majority of our plastic manufacturing process scrap directly back into our products.
- Contract with suppliers and recycling services to recycle aluminum, corrugated boxes, oils, scrap metals and remaining plastic scrap.

### Storage and Transportation

- Strategically locate warehouse network near our customers.
- Logistics program reduces empty space on trucks when shipping products to customers and other company locations resulting in 10 to 15 percent more product shipped in the same number of trips.
- Warehouse lift truck trip management and use of battery-operated lift trucks saves energy, allows for more efficient loading and reduces product damage.



## Environmental Management

- Zero environmental issue mindset with supporting environmental management systems helps ensure operations have no adverse environmental impacts on local communities and comply with all regulatory requirements.

## Products

- Invested more than \$20 million in sustainable product development, manufacturing and product introductions in 2010.
- Introduced new EarthChoice® brand of nearly 90 packaging products that includes options with sustainable and renewable resources, reduced amounts of plastics, less fossil fuel needed to manufacture, post-consumer recycled content, certified compostable and chlorine free processing.
- Aggressively engage with partners to explore and potentially develop commercially feasible solutions to manage post-consumer waste of disposable food service packaging.

Environmental responsibility goes beyond marketing claims of using post-consumer waste or declaring one material more environmentally-friendly than another.

At Pactiv, from purchasing raw materials to delivering finished products, we consider the environmental impact of our products and processes.

John McGrath  
President & CEO

# Pactiv Customer Innovation Center

Pactiv is proud to announce the relocation of our Customer Innovation Center (CIC) now located in Bedford Park, IL. The company's growth and the continued need to provide superior customer focused innovation has led to the opening of the new facility. The space will house the award winning design team as well as a State of the Art prototyping facility. The CIC provides a collaborative approach to customer solutions in one place; from industrial design and market research to tool design and tool fabrication. The expansion will build on Pactiv's legacy of providing customers with innovative solutions for custom packaging needs.

The Customer Innovation Center expands Pactiv's ability to add value to our customers by partnering with them on custom designs. In order to optimize speed to market, the Center will take prototyping



from a single shift to 24 hours a day operation. The Center will Enable Pactiv to support development projects large & small with thermoforming pilot lines dedicated to meeting the needs of our growing customer base. The CIC is close in proximity to several premier Pactiv manufacturing facilities that demonstrate our capabilities ranging from Thermoforming, Injection Molding, Printing and High Speed Automation.

## Capabilities include:

- Creative Problem Solving/Ideation Sessions
- Concept Development
- Market Research
- Rapid Prototyping
- Product Testing & Validation
- Dedicated Thermoforming Pilot Lines
- Tool Design & Fabrication
- Multiple Material Solutions
- Supply Chain Optimization



[www.pactiv.com](http://www.pactiv.com) • 888.828.2850

1900 West Field Court / Lake Forest, IL 60045  
3471 McNicoll Avenue / Scarborough, Ontario M1V 4B8 / Canada / 800.387.3282





**Earthchoice® Products**

# Material Resources



## PLA (Polylactic Acid)

PLA is a natural plastic material called Ingeo™ which is made from plants instead of oil. It is 100% annually renewable. Because PLA is a natural material, it is best used for cold applications and has a heat tolerance of 105° F. All Pactiv PLA products are **ASTM D 6400** certified and compostable.



## PLA Coated Paper Hot Cups & Soup Cups

Polylactic Acid Coated Paper is used for Pactiv's compostable hot cups and soup cups. While PLA is used for cold applications, when the PLA film is applied to paper such as our hot cups and soup cups, the PLA film takes on the properties of the paper and therefore does not melt or deform. Pactiv's PLA Lined/Coated Paper Cups are made from 100% annually renewable resources and is **ASTM D 6868** certified, compostable and chlorine free.\*



## Fiber Blend Hingeware

Pactiv's Fiber Blend Hingeware is made of a blend of pulp fibers. All the materials in the Fiber Blend Hingeware are made from sustainable, renewable resources and are **ASTM D 6868** certified, compostable, and processed chlorine free.\*



## Bagasse Blend Tableware

The Bagasse Blend Tableware is a fiber (paper) material that is made of a blend of Bagasse (Sugar Cane) and Bamboo which are sustainable and annually renewable resources. Pactiv's Bagasse Blend Tableware is **ASTM D 6868** certified and compostable.\*



## PSM (Plastarch Material)

PSM is manufactured from starch and a blend of several other materials. The base material comes from a starch that is modified in order to obtain heat resistant properties. Since PSM is derived from corn, which is an annually renewable resource, this material can handle temperatures up to 200° F making it perfect for higher heat applications.



**TFPP (Talc-Filled Polypropylene)** - TFPP contains an average of 40% less plastic polymers than standard polypropylene containers which reduces plastic usage.



**Recycled PET (Recycled Polyethylene Terephthalate)** - PET is made primarily from natural gas feedstock, whereas RPET is produced from previously used post consumer/post industrial plastic products. Pactiv uses a minimum of 25% recycled content in RPET packaging.

\*Disposable compostable products are recommended only for industrial or municipal compost facilities. For a complete list of facilities near you visit [www.findacomposter.com](http://www.findacomposter.com)



NatureWorks, Ingeo and the Ingeo logo are trademarks or registered trademarks of NatureWorks LLC in the USA and other countries. For more information regarding Ingeo™ visit [www.natureworkspla.com](http://www.natureworkspla.com)



## Hot Cups and Soup Cups

FEATURES	BENEFITS
Lined with Ingeo™	100% annually renewable material made from plants
Superior Strength	Consumer is confident when holding a large, heavy beverage
Color Coding System	Easy size recognition when pulling from inventory
Variety of Sizes	To meet both hot and cold beverage needs
Customizing Capabilities	Special print available on all sizes
*Fully Compostable in Municipal and Industrial Compost Facilities Where Available	ASTM D 6868 certified and compostable



EARTHCHOICE® Hot Cups & Soup Cups



## PLA Lined Hot Cup & Soup Cup Product Specifications

Item Number	Description	Case Cube	Case Weight	Case Sleeve	Case Pack	Cases/ Unit Load
<b>Hot Cups (Compostable)</b>						
DPHC8EC	8 oz. Hot Cup	2.33	17.00	20/50	1,000	36
DPHC10EC	10 oz. Hot Cup	3.49	21.44	20/50	1,000	24
DPHC12EC	12 oz. Hot Cup	3.13	25.70	20/50	1,000	24
DPHC16EC	16 oz. Hot Cup	3.89	34.40	20/50	1,000	18
DPHC20EC	20 oz. Hot Cup	4.60	29.80	20/50	1,000	12
<b>Hot Cup Lids - PS</b>						
L4930	Tall Sip Lid for 8 oz. Cup	1.30	6.30	10/100	1,000	68
DDL124WD	Tall Sip Lid for 10, 12, 16 & 20 oz. Cups	1.64	7.10	10/100	1,000	48
<b>Hot Cup Lid - CPLA (Compostable)</b>						
LCPLA16	CPLA Lid for 10, 12, 16, & 20 oz. Cups	1.90	10.60	20/50	1,000	28
<b>Soup Cups (Compostable)</b>						
PHSC8ECD	8 oz. PLA Lined Hot Soup Cup	2.35	10.07	10/50	500	36
PHSC12ECD	12 oz. PLA Lined Hot Soup Cup	2.44	11.70	20/25	500	36
PHSC16ECD	16 oz. PLA Lined Hot Soup Cup	2.93	13.90	20/25	500	30
PHSC32ECD	32 oz. PLA Lined Hot Soup Cup	4.22	40.80	20/25	500	16
<b>Soup Cup Lids - PS</b>						
L15561	Hot Soup Cup Lid for 8, 12 & 16 oz. Cups	2.90	13.00	20/50	1,000	30
L18934	Hot Soup Cup Lid for 32 oz. Cup	2.10	15.00	10/50	500	40

### Hot Cup & Soup Cup Lids

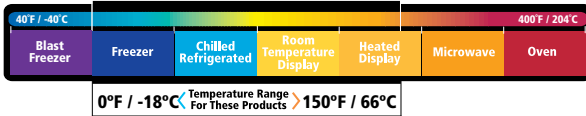

### Hot Cups & Soup Cups

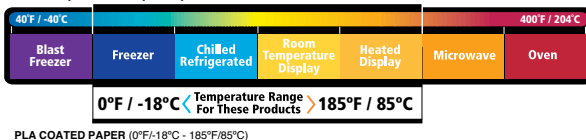

These guidelines are supplied to assist you in determining the proper use of Pactiv products. They are based upon testing and published guidelines and are reliable in most applications. However, because every food supplier's recipes, ingredients, processes and supply chain is unique, these guidelines are not a substitute for product testing. Confirmation of product acceptability under your specific conditions of use must be done by you.



NatureWorks, Ingeo and the Ingeo logo are trademarks or registered trademarks of NatureWorks LLC in the USA and other countries. For more information regarding Ingeo™ visit [www.natureworkspla.com](http://www.natureworkspla.com)

\*For a complete list of compost facilities near you visit [www.findacomposter.com](http://www.findacomposter.com)



**FEATURES**

**BENEFITS**

Made with Ingeo™	100% annually renewable material made from plants
Exceptional Clarity	Makes drink identification easy and presents contents in an upscale way
Exceptional Strength	Durable, made tough for everyday demand
Custom Printing Available	Communicates brand Image
Variety of Colors	Offer the style and value that you deserve
Optimized Cube Utilization Packs	Efficient case packs for shipping
Convenience	Cups can be filled in advance of actual use
Snap lock lids	Ensures a secure fitting lid
Stackability	Saves space
*Fully Compostable in Municipal and Industrial Compost Facilities Where Available	ASTM D 6400 certified and compostable

EARTHCHOICE® PLA Cold Drink Cups & Lids

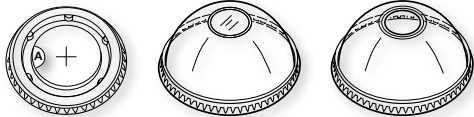

**PLA Cold Drink Cups & Lid Product Specifications**

Item Number	Description	Lid Size	Case Wt.	Cube	Sleeve	Cs. Pack	Cases/ Unit Load
<b>Cold Drink Cups</b>							
YPLA7C	7 oz. PLA Clear Unprinted Drink Cup	A	19.00	1.74	20/50	1,000	60
YPLA9C	9 oz. PLA Clear Unprinted Drink Cup	A	24.50	2.02	15/65	975	24
YPLA1412C	12 - 14 oz. PLA Clear Unprinted Drink Cup	B	23.50	2.20	10/68	680	24
YPLA160C	16 - 18 oz. PLA Clear Unprinted Drink Cup	B	26.80	2.67	6/116	696	20
YPLA21C	20 oz. PLA Clear Unprinted Drink Cup	B	28.30	2.92	10/60	600	18
YPLA24C	24 oz. PLA Clear Unprinted Drink Cup	B	26.90	2.92	10/58	580	18
YPLA9CEC	9 oz. PLA Clear Printed Drink Cup	A	24.50	2.02	15/65	975	30
YPLA1412CEC	12 - 14 oz. PLA Clear Printed Drink Cup	B	26.25	2.22	10/68	680	24
YPLA160CEC	16 - 18 oz. PLA Clear Printed Drink Cup	B	26.80	2.67	6/116	696	20
YPLA21CEC	20 oz. PLA Clear Printed Drink Cup	B	28.30	2.94	10/60	600	18
YPLA24CEC	24 oz. PLA Clear Printed Drink Cup	B	26.90	2.92	10/58	580	18
<b>Cold Drink Cup Lids</b>							
YLPLA20C	PLA Clear Flat Lid w/Straw Slot	A	8.25	1.76	12/85	1,020	24
YPLADL20CNH	PLA Clear Dome Lid w/No Hole	A	8.50	1.76	12/75	900	30
YLPLA24C	PLA Clear Flat Lid w/Straw Slot	B	8.10	1.82	15/61	915	24
YPLADL24CNH	PLA Clear Dome Lid w/No Hole	B	8.50	1.98	12/75	900	24
YPLADL24C	PLA Clear Dome Lid w/Hole	B	9.25	1.98	12/75	900	24

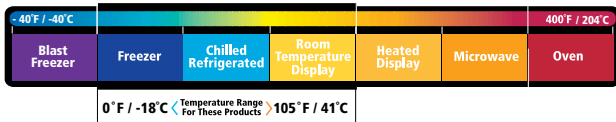

PLA (0°F/18°C - 105°F/41°C)

These guidelines are supplied to assist you in determining the proper use of Pactiv products. They are based upon testing and published guidelines and are reliable in most applications. However, because every food supplier's recipes, ingredients, processes and supply chain is unique, these guidelines are not a substitute for product testing. Confirmation of product acceptability under your specific conditions of use must be done by you.



NatureWorks, Ingeo and the Ingeo logo are trademarks or registered trademarks of NatureWorks LLC in the USA and other countries. For more information regarding Ingeo™ visit [www.natureworkspla.com](http://www.natureworkspla.com)

\*For a complete list of compost facilities near you visit [www.findacomposter.com](http://www.findacomposter.com)



Made in USA





FEATURES	BENEFITS
Made with Ingeo™	100% annually renewable material made from plants
Exceptional Clarity	Presents contents in an upscale way
Exceptional Strength	Durable, made tough for everyday demand
Custom Printing Available	Communicates brand Image
Variety of Colors	Offer the style and value that you deserve
Optimized Cube Utilization Packs	Efficient case packs for shipping
Convenience	Cups can be filled in advance of actual use
Snap lock lids	Ensures a secure fitting lid
Stackability	Saves space
*Fully Compostable in Municipal and Industrial Compost Facilities Where Available	ASTM D 6400 certified and compostable

EARTHCHOICE® PLA Portion Cups & Lids



### PLA Portion Cups & Lids Product Specifications

Item Number	Description	Cs Wt.	Cube	Sleeve	Cs Pack	Cases/ Unit Load
YSPLA200EC	2 oz. Printed PLA Clear Portion Cup	15.55	1.44	12/200	2,400	36
YSPLA300EC	3.25 oz. Printed PLA Clear Portion Cup	23.10	2.06	12/200	2,400	27
YSPLA400EC	4 oz. Printed PLA Clear Portion Cup	25.05	2.06	12/200	2,400	27
YLSPLA2	2 oz. PLA Clear Portion Cup Lid	8.20	1.41	24/100	2,400	33
YLSPLA3	3.25 & 4 oz. PLA Clear Portion Cup Lid	10.75	1.94	20/120	2,400	27

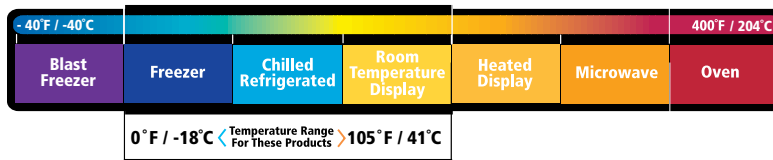

PLA (0°F/18°C - 105°F/41°C)

These guidelines are supplied to assist you in determining the proper use of Pactiv products. They are based upon testing and published guidelines and are reliable in most applications. However, because every food supplier's recipes, ingredients, processes and supply chain is unique, these guidelines are not a substitute for product testing. Confirmation of product acceptability under your specific conditions of use must be done by you.

\*For a complete list of compost facilities near you visit [www.findacomposter.com](http://www.findacomposter.com)





EARTHCHOICE® Fiber Blend Hingeware

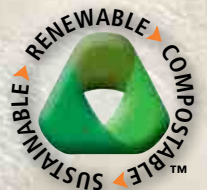

FEATURES	BENEFITS
Fiber (Paper) Material	Product is made of a blend of fiber and pulp materials
SFI Raw Materials	Made from sustainable, renewable resources
*Fully Compostable in Municipal and Industrial Compost Facilities Where Available	ASTM D 6868 certified & compostable
Strong	Offers durable construction for multi-food applications
Double Tab Lock (Hinged Lids)	Keeps container securely closed
All Natural White Appearance	Processed chlorine free
Stackability	Helps multiple orders stack easily
Soak Through Resistant Design	Resists grease, moisture and helps eliminate messy leaks

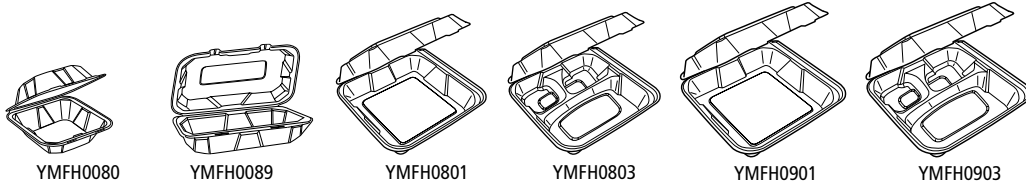

## Fiber Blend Hingeware Product Specifications

Product Number	Description	Dimensions (in inches)	Case Cube	Case Approx. Wt.	Case Sleeve	Case Pack	Cases/ Unit Load
YMFH00800000	1-Compartment Dual Tab Sandwich Container	5.8 x 5.8 x 3.3	1.56	24.05	2/250	500	32
YMFH00890000	1-Compartment Dual Tab Utility Container	9.1 x 6.1 x 3.3	0.89	10.61	1/150	150	60
YMFH08010000	Medium 1-Compartment Dual Tab Container	7.8 x 7.8 x 2.8	0.90	10.93	1/150	150	60
YMFH08030000	Medium 3-Compartment Dual Tab Container	7.8 x 7.8 x 2.8	1.04	11.59	1/150	150	54
YMFH09010000	Large 1-Compartment Dual Tab Container	9 x 9 x 3.5	1.27	14.24	1/150	150	40
YMFH09030000	Large 3 -Compartment Dual Tab Container	9 x 9 x 3.5	1.50	14.90	1/150	150	30

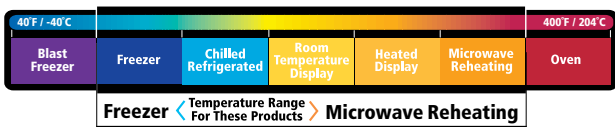

These guidelines are supplied to assist you in determining the proper use of Pactiv products. They are based upon testing and published guidelines and are reliable in most applications. However, because every food supplier's recipes, ingredients, processes and supply chain is unique, these guidelines are not a substitute for product testing. Confirmation of product acceptability under your specific conditions of use must be done by you.

\*For a complete list of compost facilities near you visit [www.findacomposter.com](http://www.findacomposter.com)





EARTHCHOICE® Bagasse Blend Tableware



FEATURES	BENEFITS
Fiber (Paper) Material	Product is made of a blend of Bagasse (Sugar Cane) and Bamboo which are sustainable, annually renewable resources
*Fully Compostable in Municipal and Industrial Facilities Where Available	ASTM D 6868 certified & compostable
Strong	Offers durable construction for multi-food applications
All Natural White Appearance	Provides a brilliant, white exterior
Soak Through Resistant Design	Resists grease, moisture and helps eliminate messy leaks
Wide Variety of Sizes	To meet all your tableware and serving tray applications

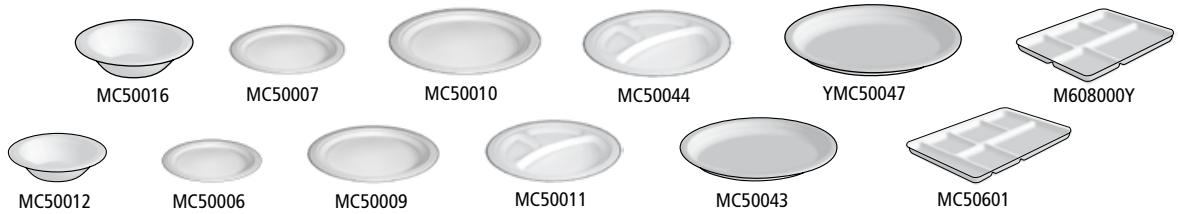

## Bagasse Blend Tableware Product Specifications

Product Number	Description	Capacity (fl. oz.)	Dimensions (in inches)			Vert. Depth (in inches)	Case Cube	Case Wt.	Sleeve	Case Pack	Cases/ Unit Load
			Top Out	Top In	Bottom						
MC500120001	12 oz. Placesetter® Preferred™ Bowl	12	6 3/8	5	3 3/8	1 1/2	2.41	24.26	8/125	1000	18
MC500160001	16 oz. Placesetter® Preferred™ Bowl	16	6 1/2	5 7/8	3 7/8	1 1/2	2.73	28.11	8/125	1000	18
MC500060001	6" Placesetter® Preferred™ Snack Plate	--	6	4 7/8	4	5/8	1.32	19.29	8/125	1000	36
MC500070001	6.75" Placesetter® Preferred™ Snack Plate	--	6 3/4	5 3/4	5	5/8	1.93	20.84	8/125	1000	36
YMC500090002*	8.75" Placesetter® Preferred™ Plate	--	8 3/4	7 3/8	6	3/4	1.34	17.64	4/125	500	30
YMC500110002*	8.75" Placesetter® Preferred™ 3-Cmpt. Plate	--	8 3/4	7 3/8	6	3/4	1.23	17.64	4/125	500	40
MC500440002	10" Placesetter® Preferred 3-Cmpt. Plate	--	10	8 1/4	7	1	2.74	25.91	4/125	500	20
MC500100002	10" Placesetter® Preferred Plate	--	10	8 1/2	7 3/8	3/4	1.89	25.90	4/125	500	20
MC500430001	7.5" x 10" Placesetter® Preferred Oval Platter	--	7 1/2 x 10	6 1/8 x 8 3/4	4 1/2 x 7	1	1.56	19.08	4/125	500	36
YMC500470001*	9.875" x 12.5" Placesetter® Preferred Oval Platter	--	9 7/8 x 12 1/2	8 7/8 x 11 1/2	7 1/4 x 9 3/4	1	2.30	33.02	4/125	500	24
MC57603	6 Junior White 6-Compartment Tray	--	10 3/4 x 10 3/4	10 3/8 x 10 3/8	9 7/16 x 9 7/16	1	1.68	22.44	1/250	250	24
MC50601	6 Senior White 6-Compartment Tray	--	8 1/2 x 12 1/2	8 x 12	6 3/4 x 8 3/4	1	1.76	23.20	2/125	250	36
M608000Y	5 Sophomore White 5-Compartment Tray	--	8 1/2 x 10 1/2	7 3/16 x 9 15/16	6 3/4 x 8 3/4	1	2.57	39.00	2/250	500	18

\*Item may not be available in all regions. Please contact your Pactiv sales representative for minimum and lead time.

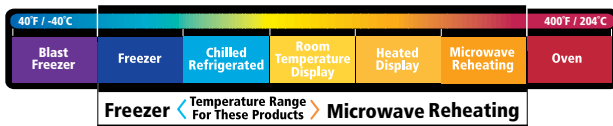

These guidelines are supplied to assist you in determining the proper use of Pactiv products. They are based upon testing and published guidelines and are reliable in most applications. However, because every food supplier's recipes, ingredients, processes and supply chain is unique, these guidelines are not a substitute for product testing. Confirmation of product acceptability under your specific conditions of use must be done by you.

\*For a complete list of compost facilities near you visit [www.findacomposter.com](http://www.findacomposter.com)

EARTHCHOICE® PLA Hinged & Deli Containers

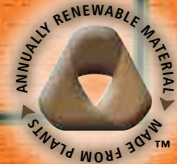
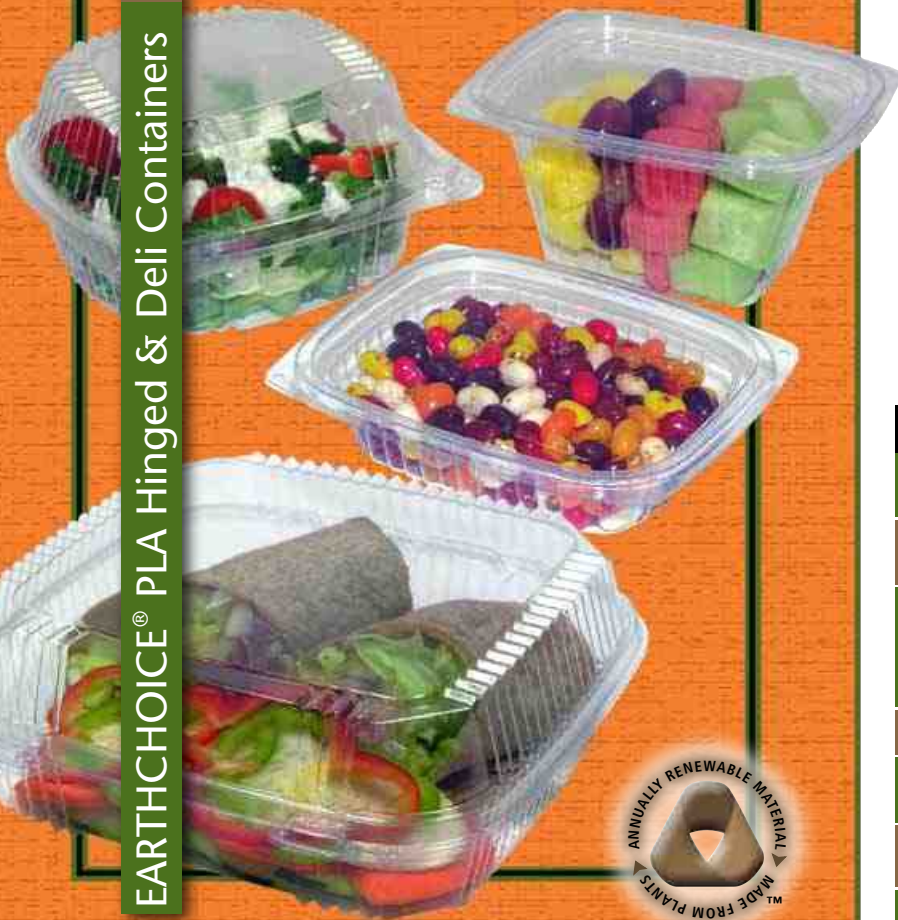

**MADE IN USA  
COMPOSTABLE**

Embossed Hinged Lids and Deli Containers



FEATURES	BENEFITS
Made with Ingeo™	100% annually renewable material made from plants
Exceptional Clarity	Makes identification easy and presents contents in an upscale way
*Fully Compostable in Municipal and Industrial Compost Facilities Where Available	ASTM D 6400 certified and compostable
Stackability	Helps multiple orders stack easily
Label Panels	Allows for pricing, nutrition, and preparation labels
SmartLock® Hinged Lids	Audible "click" indicates a secure closure
Leak Resistant Deli Lid Closure	Prevents messy leaks and spills

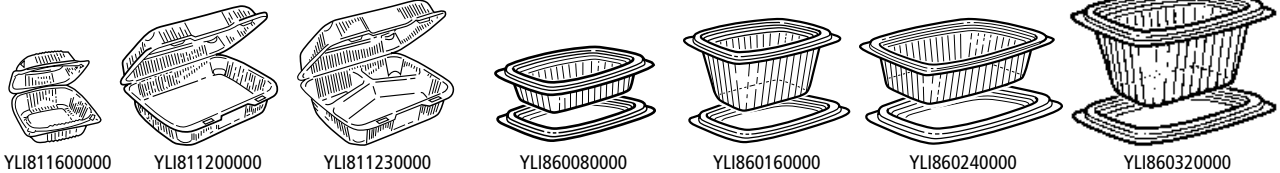

**PLA Hinged & Deli Container Product Specifications**

Item#	Description	Capacity	Dimensions	Case Cube	Case Weight	Case Sleeve	Case Pack	Cases/ Unit Load
<b>Clear Hinged Lid Containers</b>								
YLI811600000	EarthChoice® 6 in. Clear Hinged Container	20	5 3/4 x 6 x 3	3.33	22.80	4/125	500	16
YLI811200000	EarthChoice® Medium 1-Cmpt. Clear Hinged Cont.	49	8 13/64 x 8 11/32 x 2 29/32	2.06	17.93	2/100	200	24
YLI811230000	EarthChoice® Medium 3-Cmpt. Clear Hinged Cont.	5 (sm), 14 (lg)	8 13/64 x 8 11/32 x 2 29/32	2.06	17.93	2/100	200	24
<b>Clear Deli Containers &amp; Lids</b>								
YLI860080000	EarthChoice® 8 oz. Clear Deli Container w/Lid	8	5.9 x 4.9 x 1.25	2.26	10.03	5/51	255	24
YLI860160000	EarthChoice® 16 oz. Clear Deli Container w/Lid	16	5.9 x 4.9 x 2.75	2.56	11.82	5/51	255	24
YLI860240000	EarthChoice® 24oz. Clear Deli Container w/Lid	24	7.5 x 6.5	2.68	10.73	2/100	200	18
YLI860320000	EarthChoice® 32 oz. Clear Deli Container w/Lid	32	7.5 x 6.5 x 2.70	2.93	13.85	4/50	200	18

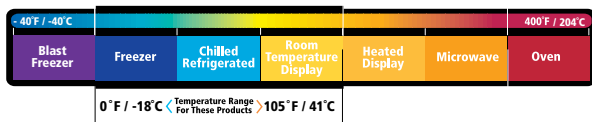

PLA (0°F/18°C - 105°F/41°C)

These guidelines are supplied to assist you in determining the proper use of Pactiv products. They are based upon testing and published guidelines and are reliable in most applications. However, because every food supplier's recipes, ingredients, processes and supply chain is unique, these guidelines are not a substitute for product testing. Confirmation of product acceptability under your specific conditions of use must be done by you.



**Ingeo** NatureWorks, Ingeo and the Ingeo logo are trademarks or registered trademarks of NatureWorks LLC in the USA and other countries. For more information regarding Ingeo™ visit [www.natureworkspla.com](http://www.natureworkspla.com)

\*For a complete list of compost facilities near you visit [www.findacomposter.com](http://www.findacomposter.com)

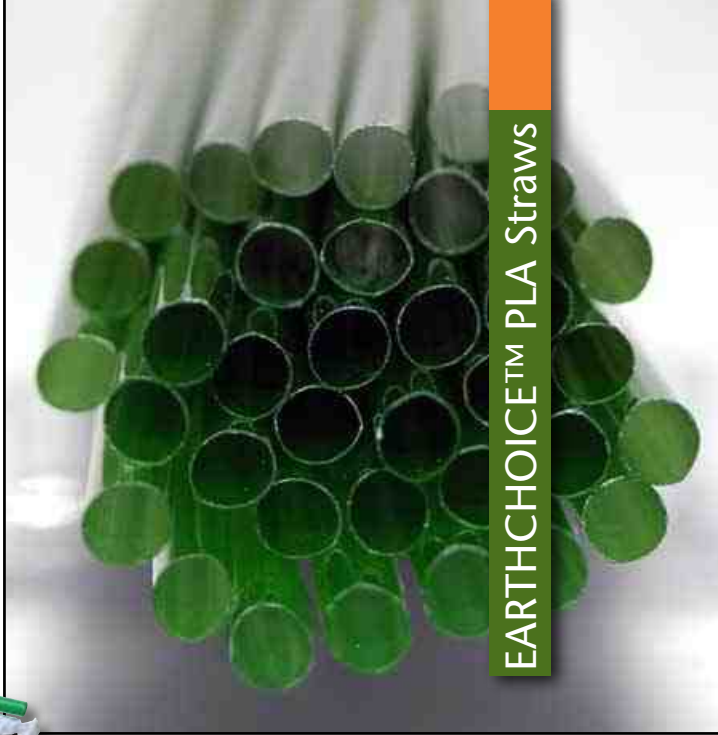

EARTHCHOICE™ PLA Straws

FEATURES	BENEFITS
Made With PLA	100% annually renewable material made from plants
*Fully Compostable in Municipal and Industrial Compost Facilities Where Available	ASTM D 6400 certified and compostable
Individually Wrapped	To promote a more sanitary image
Available in 2 Sizes	Suits any cold menu beverage application



Made in USA



### PLA Straws Product Specifications

Item Number	Description	Case		Cases/ Unit Load
		Cube	Weight	
STPLAWJ7724EC	EarthChoice® Green Drink Straw - 7.75" Jumbo Wrapped	3.92	14.30	18
STPLAWJ9516EC	EarthChoice® Green Drink Straw - 9.5" Jumbo Wrapped	4.71	18.70	18
STPLAWJ754EC	EarthChoice® Green Drink Straw - 7.75" Jumbo Wrapped	4.30	26.00	20

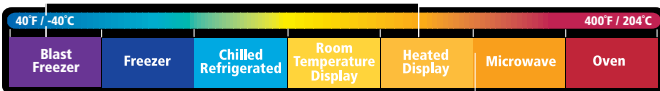

0°F / -18°C < Temperature Range For These Products > 105°F / 46°C

PLA Straws (0°F/-18°C - 105°F/46°C)

These guidelines are supplied to assist you in determining the proper use of Pactiv products. They are based upon testing and published guidelines and are reliable in most applications. However, because every food supplier's recipes, ingredients, processes and supply chain is unique, these guidelines are not a substitute for product testing. Confirmation of product acceptability under your specific conditions of use must be done by you.



EARTHCHOICE® Recycled Coffee Jacket



### Hot Cups Recycled Coffee Jacket

FEATURES	BENEFITS
Made from 100% Recycled Fibers, with a Minimum of 30% Post Consumer Material	Improves heat resistance when handling hot cups



Made in USA

### Recycled Coffee Jacket Product Specifications

Item Number	Description	Case		Cases/ Unit Load
		Cube	Weight	
EC2000	EarthChoice® Recycled Coffee Jacket	.60	13.80	40



EARTHCHOICE® TFPF SmartLock® Hinged Lids

FEATURES	BENEFITS
TFPP Talc-Filled Polypropylene	40% average talc blended material with polypropylene reduces plastic usage
Exceptional Temperature Endurance	Microwaveable reheating up to 250° F (121° C)
SmartLock® Closure System	Audible "click" indicates a secure closure
Stackability	Helps multiple orders stack easily
Textured Sidewalls	Provides more secure handling
Soak Through Resistance	Resists grease, moisture and helps eliminate messy leaking
Optimized Cube Utilization Packs	Efficient case packs for shipping
5 Popular Sizes	Fits any size "To-Go" applications

\*This product is not compostable

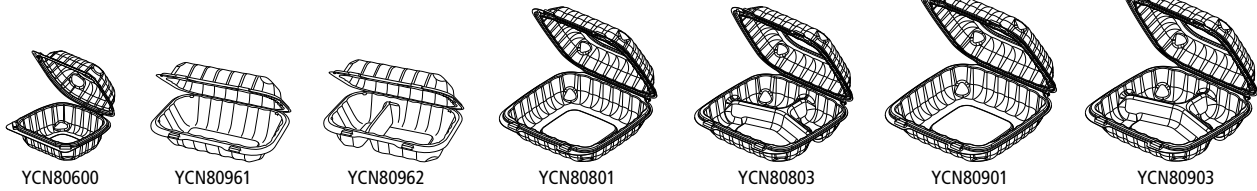

### TFPP SmartLock® Hinged Lids Specifications

Item Number	Description	Capacity (fl. Oz.)	Dimensions (in inches)	Case		Case		Cases/ Unit Load
				Cube	Weight	Sleeve	Pack	
YCN806000000	1-Cmpt. SmartLock® Sandwich Hinged Container	16	5.95" x 5.75" x 3.25"	3.05	23.53	4/100	400	16
YCN809610000	1-Cmpt. SmartLock® Hinged Hoagie Container	24	9" x 6" x 3"	3.34	25.09	2/135	270	16
YCN809620000	2-Cmpt. SmartLock® Hinged Hoagie Container	--	9" x 6" x 3"	3.34	25.09	2/135	270	16
YCN808010000	1-Cmpt. SmartLock® Medium Hinged Container	32	8.3" x 8.3" x 3.4"	2.79	23.82	2/100	200	18
YCN808030000	3-Cmpt. SmartLock® Medium Hinged Container	4/4/14	8.3" x 8.3" x 3.4"	2.79	23.82	2/100	200	18
YCN809010000	1-Cmpt. SmartLock® Large Hinged Container	42	8.87" x 9.3" x 3.3"	1.73	17.08	1/120	120	30
YCN809030000	3-Cmpt. SmartLock® Large Hinged Container	6/6/18	8.87" x 9.3" x 3.3"	1.73	17.08	1/120	120	30

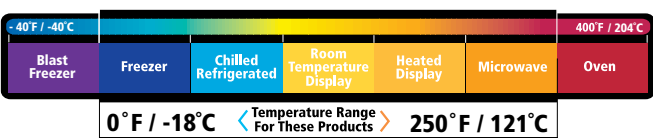

PP (0°F/-18°C - 250°F/121°C)

These guidelines are supplied to assist you in determining the proper use of Pactiv products. They are based upon testing and published guidelines and are reliable in most applications. However, because every food supplier's recipes, ingredients, processes and supply chain is unique, these guidelines are not a substitute for product testing. Confirmation of product acceptability under your specific conditions of use must be done by you.



Made in USA



### FEATURES

Manufactured From Plants and Modified With Starch

Sturdy

Full Cutlery Kit Assembled In U.S.A.

### BENEFITS

- Annually renewable material made from plants
- Obtains heat resistant properties handling temperatures up to 200° F
- Perfect for higher heat applications

Enables ease of use when cutting food

Includes salt and pepper packet in addition to Fork, Spoon, Knife, and Napkin

\*This product is not compostable



### PSM Cutlery Product Specifications

Item Number	Description	Case		Case Sleeve	Case Pack	Cases/ Unit Load
		Cube	Weight			
<b>Cutlery</b>						
PSMFT	EarthChoice® Full Length Heavy PSM Fork	0.90	15.90	10/100	1,000	45
PSMKT	EarthChoice® Full Length Heavy PSM Knife	0.70	15.90	10/100	1,000	45
PSMST	EarthChoice® Full Length Heavy PSM Spoon	0.47	14.50	10/100	1,000	45
PSMKFSKTNSP	EarthChoice® Full Length Heavy Fork, Spoon, Knife, 13" x 17" Napkin, Salt & Pepper Packets Cutlery Kit	1.88	15.75	1/250	250	28

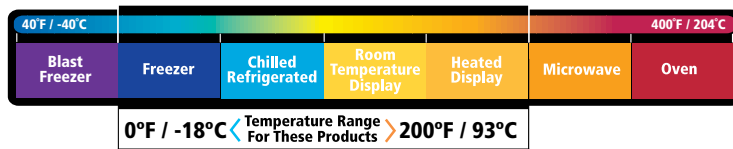

PSM (0°F/-18°C - 185°F/85°C)

These guidelines are supplied to assist you in determining the proper use of Pactiv products. They are based upon testing and published guidelines and are reliable in most applications. However, because every food supplier's recipes, ingredients, processes and supply chain is unique, these guidelines are not a substitute for product testing. Confirmation of product acceptability under your specific conditions of use must be done by you.





EARTHCHOICE® RPET Hinged Lid Containers

**Contains a Minimum of 25% Recycled Content**



## Recycled PET SmartLock® Hinged Deli/Bakery Containers

FEATURES	BENEFITS
SmartLock® Closure System	Easy to lock, aids in employee efficiency
Audible Click Closure	Indicates a secure lock which helps maintain freshness
Smooth Panel Areas	Provides ideal label placement
Variety of Popular Sizes	Useful for a broad range of applications
RPET Material	Crack resistant; offers extended use for low temperature applications

\*This product is not compostable

## Recycled PET Hinged Deli Containers

RPET Material	Provides excellent clarity and freezer performance
Hinged Lid	Eliminates lost lids, saves storage space and reduces inventory costs
Leak Resistant Closure	Prevents messy leaks and spills
Textured Lift/Hold Tab	Allows easy opening
Variety of Sizes	Ensures you can choose the right container for your application
Label Panels	Allow for pricing, nutrition and preparation labels
Excellent Clarity	Promotes impulse purchases
Ribbed Sidewalls	Help prevent crushing while also improving stacking performance

\*This product is not compostable



## Recycled PET SmartLock® Hinged Deli/Bakery & Hinged Deli Containers Specifications

Product Number	Description	Capacity (fl. oz.)	Dimension (in inches) Closed OD (L x W x H)	Case Cube	Case Approx. Wt.	Packing Sleeve	Case	Cases/ Unit Load
<b>RPET SmartLock® Deli/Bakery Semi-Smoothwall Clear Hingeware (SS)</b>								
YCASH10500000	5" 1-Compartment SS HLC-RPET	11 oz.	5.43 x 5.29 x 2.74	2.66	15.85	3/125	375	40
YCASH11600000	6" 1-Compartment SS HLC-RPET	20 oz.	6.15 x 5.80 x 2.99	3.71	21.22	4/100	400	32
OCASH11200000	Medium 1-Compartment SS HLC-RPET	49 oz.	8.34 x 8.32 x 2.83	3.74	22.27	2/100	200	20
OCASH11230000	Medium 3-Compartment SS HLC-RPET	5 oz. (S) - 14 oz. (L)	8.34 x 8.32 x 2.83	3.74	22.27	2/100	200	20
OCASH11100000	Large 1-Compartment SS HLC-RPET	62 oz.	8.87 x 9.23 x 2.80	5.00	34.00	2/125	250	20

Product Number	Description	Case Dimensions (in inches)	Case Cube	Case Approx. Wt.	Case Sleeve	Case Pack	Cases/ Unit Load
<b>RPET Hinged Lid Deli Containers</b>							
OCA910080000	8 oz. Clear Hinged Container	4.92 x 5.87 x 1.32	2.40	10.30	1/200	200	48
OCA910120000	12 oz. Clear Hinged Container	4.92 x 5.87 x 1.89	2.40	10.94	1/200	200	48
OCA910160000	16 oz. Clear Hinged Container	4.92 x 5.87 x 2.48	2.40	11.09	2/100	200	48
OCA910240000	24 oz. Clear Hinged Container	6.00 x 7.28 x 2.28	3.66	16.76	1/200	200	27
OCA910320000	32 oz. Clear Hinged Container	6.00 x 7.28 x 2.99	3.66	17.16	2/100	200	27
YCA910480000	48 oz. Clear Hinged Container	7.35 x 8.96 x 2.86	4.12	23.39	2/95	195	24
YCA910640000	64 oz. Clear Hinged Container	7.35 x 8.96 x 3.72	4.12	22.60	2/95	195	24

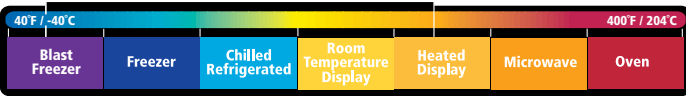

-20°F / -29°C < Temperature Range For These Products > 120°F / 49°C

PET (-20°F/-29°C - 120°F/49°C)

These guidelines are supplied to assist you in determining the proper use of Pactiv products. They are based upon testing and published guidelines and are reliable in most applications. However, because every food supplier's recipes, ingredients, processes and supply chain is unique, these guidelines are not a substitute for product testing. Confirmation of product acceptability under your specific conditions of use must be done by you.



**Made in USA**

[www.pactiv.com](http://www.pactiv.com) • 888.828.2850 ext. 3217

1900 West Field Court / Lake Forest, IL 60045 / 800.476.4300  
2010 Ellesmere Road, Units 6-9 / Scarborough, Ontario M1H 3B1 / Canada / 800.387.3282



08/12 Lit# 12-3741H  
© PACTIV LLC 2012





# Bakery Packaging





Product Number	Description	Page
YC18-1124	SMARTLOCK® CLEAR HINGED COOKIE CONTAINER.....	A11
YC18-1160	SMARTLOCK® CLEAR 6" HINGED LID W/1-CMPT. TRAY.....	A11
YC18-1224	SMARTLOCK® CLEAR HINGED COOKIE CONTAINER.....	A11
YC18-2025	SMARTLOCK® CLEAR SMALL HINGED LID.....	A11
YC18-2030	SMARTLOCK® CLEAR HINGED LID W/1-CMPT. TRAY (SS).....	A11
YC18-2035	SMARTLOCK® CLEAR HINGED LID W/1-CMPT. TRAY (DS).....	A11
YC18-2040	SMARTLOCK® CLEAR HINGED LID W/1-CMPT. TRAY (DD).....	A11
YC18-3035	SMARTLOCK® CLEAR UTILITY (DS).....	A11
YC18-9006	6" HINGED PIE WEDGE.....	A17
YC18-9345	SMARTLOCK® SHALLOW DOME MINI LOAF HINGEWARE.....	A11
YC18-9701	7" CAKE W/DEEP DOME FOR 2-3 LAYER CAKE.....	A15
YC18-9702	7" CAKE W/SHALLOW DOME FOR 1-2 LAYER CAKE.....	A15
YC18-9801	8" CAKE W/DEEP DOME FOR 2-3 LAYER CAKE.....	A15
YC18-9802	8" CAKE W/SHALLOW DOME FOR 1-2 LAYER CAKE.....	A15
YC18-9851	8" HALF CAKE W/DEEP DOME FOR 2-3 LAYER CAKE.....	A15
YC18-9901	9" CAKE W/DEEP DOME FOR 2-3 LAYER CAKE.....	A15
YC18-9902	9" CAKE W/SHALLOW DOME FOR 1-2 LAYER CAKE.....	A15
YC18-D450	CLEARVIEW™ TRAYMATES™ DEEP DOME FOR 4S FOAM TRAYS.....	A13
YC18-S250	CLEARVIEW™ TRAYMATES™ SHALLOW DOME FOR 2 AND 2S FOAM TRAYS.....	A13
YC18-S450	CLEARVIEW™ TRAYMATES™ SHALLOW DOME FOR 4S FOAM TRAYS.....	A13
YEH8-7024	CLEARVIEW™ ROSEWARE™ 24 OZ. BOWL.....	A11
YEH8-7035	CLEARVIEW™ ROSEWARE™ 35 OZ. BOWL.....	A11
YEH8-9030	8" PIE CONTAINER W/SHALLOW DOME.....	A17
YEH8-9035	9" PIE CONTAINER W/SHALLOW DOME.....	A17
YEH8-9130	8" PIE CONTAINER W/DEEP DOME.....	A17
YEH8-9135	9" PIE CONTAINER W/DEEP DOME.....	A17
YEH8-9701	7" CAKE W/DEEP DOME FOR 2-3 LAYER CAKE.....	A17
YEH8-9702	7" CAKE W/SHALLOW DOME FOR 1-2 LAYER CAKE.....	A17
YEH8-9801	8" CAKE W/DEEP DOME FOR 2-3 LAYER CAKE.....	A17
YEH8-9802	8" CAKE W/SHALLOW DOME FOR 1-2 LAYER CAKE.....	A17
YEH8-9851	8" HALF CAKE W/DEEP DOME FOR 2-3 LAYER CAKE.....	A17
YEH8-9901	9" CAKE W/DEEP DOME FOR 2-3 LAYER CAKE.....	A17
YEH8-9902	9" CAKE W/SHALLOW DOME FOR 1-2 LAYER CAKE.....	A17
YESB350FTAB	3.5" FLUTED DOME W/BLACK BASE FOR 1/8 SHEETCAKE-COMBO.....	A21
YESB425LRTAB	4.25" APET ROSEDOME™ W/LABEL PANEL W/BLACK BASE FOR 1/8 SHEETCAKE.....	A21
YESB500FTAB	5" APET FLUTED DOME W/BLACK BASE FOR 1/8 SHEETCAKE.....	A21
YESB500RTAB	5" APET ROSEDOME™ W/BLACK BASE FOR 1/8 SHEETCAKE.....	A21
YHR400R		
YHRB400R		
YHRB500F	5" APET FLUTED DOME W/BLACK BASE FOR 8" HALF ROUND CAKE.....	A19
YHRB500R100	5" ROSEDOME™ W/BLACK BASE FOR 8" HALF ROUND CAKE-COMBO.....	A19
YHSB1TAB	1/2 BLACK SHEET CASE BASE.....	A21
YHSB500F1TAB	5" APET FLUTED DOME W/BLACK BASE FOR 1/2 SHEETCAKE.....	A21
YHSB500R1TAB	5" APET ROSEDOME™ W/BLACK BASE FOR 1/2 SHEETCAKE.....	A21
YL509	FOIL LAMINATED BOARD COVER FOR 9" ROUND.....	A5
YLI811200000	EARTHCHOICE® PLA MEDIUM 1-CMPT. CLEAR HINGED CONTAINER.....	A11
YLI811230000	EARTHCHOICE® PLA MEDIUM 3-CMPT. CLEAR HINGED CONTAINER.....	A11
YLI811600000	6" EARTHCHOICE® PLA CLEAR HINGED CONTAINER.....	A11
YLI860080000	8 OZ. EARTHCHOICE® PLA CLEAR DELI CONTAINER W/LID.....	A11
YLI860160000	16 OZ. EARTHCHOICE® PLA CLEAR DELI CONTAINER W/LID.....	A11
YLI860240000	24 OZ. EARTHCHOICE® PLA CLEAR DELI CONTAINER W/LID.....	A11
YLI860320000	32 OZ. EARTHCHOICE® PLA CLEAR DELI CONTAINER W/LID.....	A11
YP5095	SHALLOW PLASTIC DOME FOR 9" ROUND.....	A5
YP527	PLASTIC DOME FOR 7" ROUND.....	A5
YP558	PLASTIC DOME FOR 558 ROUND.....	A5
YP6042	PLASTIC DOME FOR 1/4 SHEET CAKE.....	A9
YP664	PLASTIC DOME FOR 8" SQUARE.....	A3
YP768	PLASTIC DOME COVER FOR OBLONG PANS.....	A3
YP92008HU	DOME LID FOR 92008, 92012, 92016, 92016K, 92025.....	A13
YP92025HU	DOME LID FOR 92025, 92032, 92032K, 92048, 92064.....	A13
YP92025S	FLAT LID FOR 92025, 92032, 92032K, 92048, 92064.....	A13
YQSB425FSTAB	.....	A21
YQSB425LRLTAB	4.25" APET ROSEDOME™ W/BLACK BASE FOR 1/4 SHEETCAKE.....	A21
YQSB425LRSTAB	4.25" APET SWIRL 1/4 SHEETCAKE DOME W/BLACK BASE.....	A33
YQSB500FSTAB	5" APET FLUTED DOME W/BLACK BASE FOR 1/4 SHEETCAKE.....	A21, A33
YQSB500RSTAB	5" APET ROSEDOME™ W/BLACK BASE FOR 1/4 SHEETCAKE.....	A21, A33
YQSB600FSTAB	6" APET FLUTED DOME W/BLACK BASE FOR 1/4 SHEETCAKE.....	A21, A33
YQSBSTAB	1/4 APET BLACK SHEETCAKE BASE.....	A21

Product Number	Description	Page
----------------	-------------	------



## Aluminum Loaf Pans



616-35

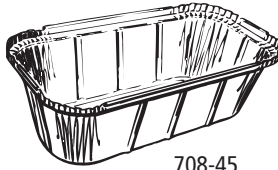

708-45

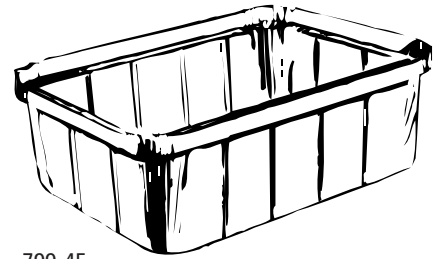

799-45

## Aluminum Oblongs and Squares — Full Curl and Vertical Curl

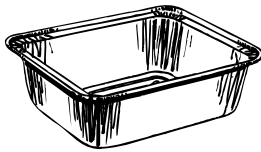

645-30

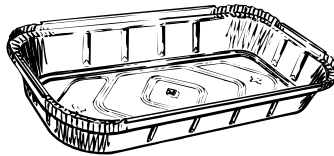

687-35

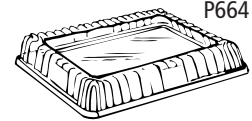

P664

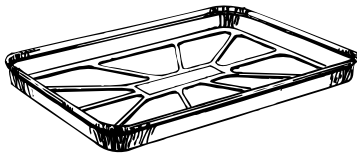

629-30

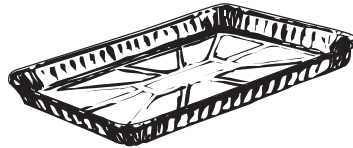

6001-25

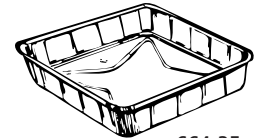

664-35

## Aluminum Oblongs and Squares — Interrupted Vertical Curl

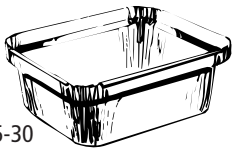

Y705-30

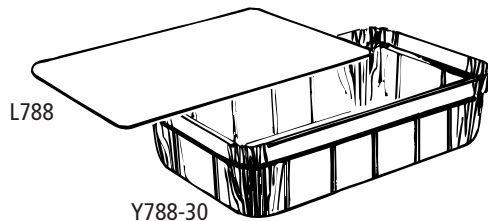

Y788-30

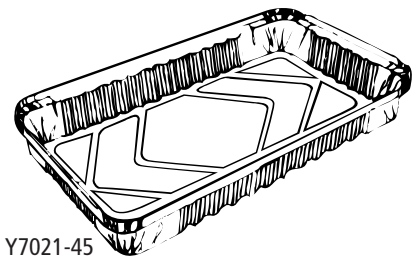

Y7021-45

### Aluminum Loaf Pans

Product Number	Description	Capacity (fl. oz.)	Top Out	Dimensions (in inches)		Vert. Depth	Case Cube	Case Weight	Rim Style	Case Pack
				Top In	Bottom					
616-35	1 lb. Loaf Pan	16.0	6 1/8 x 3 3/4	5 23/32 x 3 11/32	4 29/32 x 2 17/32	2 1/32	2.44	23.11	F.C.	1000
637-35	1 1/2 lb. Loaf Pan	29.0	8 x 4 1/4	7 3/8 x 3 5/8	6 3/4 x 3	2 11/32	2.84	18.54	F.C.	500
608-35	2 lb. Loaf Pan	35.2	8 5/8 x 4 1/2	8 x 3 7/8	7 3/8 x 3 1/4	2 1/2	3.91	21.26	F.C.	500
708-45	2 lb. Loaf Pan	38.0	8 7/16 x 4 5/16	8 x 3 7/8	7 13/32 x 3 9/32	2 31/64	5.78	27.80	I.V.C.	500
799-45	5 lb. Loaf Pan	76.0	9 5/8 x 7 1/8	9 x 6 7/16	8 1/8 x 5 9/16	2 23/32	4.06	21.00	I.V.C.	250
L799	Foil-Laminated Board Cover for 799	--	9 1/2 x 6 31/32	--	--	--	0.30	8.00	--	250

### Aluminum Oblongs and Squares — Full Curl and Vertical Curl

Product Number	Description	Capacity (fl. oz.)	Top Out	Dimensions (in inches)		Vert. Depth	Case Cube	Case Weight	Rim Style	Sleeve	Case Pack	Cases/ Unit Load
				Top In	Bottom							
645-30	14 oz. Casserole	13.7	5 17/32 x 4 17/32	5 1/16 x 4 1/16	4 15/32 x 3 15/32	1 1/2	2.06	16.82	V.C.		1000	
687-35	Oblong Tray	13.5	7 3/8 x 4 5/8	7 x 4 1/4	6 3/8 x 3 5/8	31/32	3.04	20.97	V.C.		1000	
6088-30	Oblong Tray	24.5	7 7/8 x 5 7/8	7 1/2 x 5 1/2	6 7/8 x 4 7/8	1 3/8	4.46	27.87	V.C.		1000	
6448-35	1 1/2 lb. Entree Pan	25.0	7 7/8 x 5 7/8	7 1/2 x 5 1/2	6 15/16 x 4 13/16	1 1/4	3.72	29.14	V.C.		1000	
6059-35	Oblong Cake Pan	25.2	8 5/8 x 6	8 x 5 3/8	7 11/32 x 4 23/32	1 19/64	2.48	16.55	F.C.		500	
629-30	Oblong Danish Pan	22.0	9 1/2 x 6 7/8	9 5/32 x 6 17/32	8 15/16 x 6 3/16	3/4	2.84	15.44	V.C.		500	
6001-25	Danish Ribbed Sidewall Pan	25.0	11 1/4 x 7 1/4	10 7/8 x 6 7/8	10 5/8 x 6 5/8	23/32	3.48	16.46	V.C.		500	
6002-30	Danish Ribbed Sidewall Pan	24.5	12 3/8 x 5 3/8	11 7/8 x 4 7/8	11 1/2 x 4 1/2	1	2.90	16.80	V.C.		500	
664-35	8" Square Cake Pan	32.2	7 7/8 x 7 7/8	7 3/8 x 7 3/8	6 7/8 x 6 7/8	1 5/16	3.30	20.98	V.C.		500	
YP664	Plastic Dome for 664	--	8 1/4 x 8 1/4	7 7/16 x 7 7/16	6 1/2 x 6 1/2	1 1/2	2.65	9.39	--	4/63	252	18

### Aluminum Oblongs and Squares — Interrupted Vertical Curl

Product Number	Description	Capacity (fl. oz.)	Top Out	Dimensions (in inches)		Vert. Depth	Case Cube	Case Weight	Rim Style	Sleeve	Case Pack	Cases/ Unit Load
				Top In	Bottom							
Y705-30	1 lb. Oblong Pan	15.0	5 9/16 x 4 9/16	5 1/16 x 4 1/16	4 5/16 x 3 5/16	1 5/8	2.47	20.40	I.V.C.		1200	24
L705	Foil-Laminated Board Cover for 705	--	5 17/32 x 4 17/32	--	--	--	0.36	14.10	--		1000	
706-30	13 oz. Oblong Pan	13.0	6 21/32 x 5	6 1/32 x 4 3/8	5 13/32 x 3 3/4	1 1/16	5.06	23.58	I.V.C.		1000	
747-30	1 1/2 lb. Oblong Pan	23.7	7 1/16 x 5 1/8	6 9/16 x 4 5/8	5 7/8 x 3 15/16	1 11/16	3.09	14.82	I.V.C.		500	
L747	Foil-Laminated Board Cover for 747	--	7 x 5 1/16	--	--	--	0.24	7.00	--		500	
Y768-30	1 1/2 lb. Oblong Pan	25.0	8 1/2 x 6	8 x 5 1/2	7 1/2 x 5	1 3/16	1.75	10.88	I.V.C.		400	30
Y788-30	2 1/4 lb. Oblong Pan	36.0	8 7/16 x 5 15/16	7 15/16 x 5 7/16	7 x 4 9/16	1 13/16	1.83	12.21	I.V.C.		400	30
L788	Foil-Laminated Board Cover for 768, 788, 71039, 71049	--	8 13/32 x 5 29/32	--	--	--	0.29	10.00	--		500	
YP768	Plastic Dome Cover for 768 & 788	--	8 3/8 x 5 7/8	7 23/32 x 5 7/32	7 11/32 x 4 27/32	11/16	1.23	14.52	--	4/200	800	45
L739	Foil-Laminated Board Cover for 758	--	8 7/16 x 6 5/16	--	--	--	0.31	10.00	--		500	
7002-40	3 lb. Oblong Pan - Diamond Bot. Emb.	47.5	12 3/8 x 6 1/4	11 3/4 x 5 5/8	11 1/16 x 4 15/16	1 1/2	6.27	31.67	I.V.C.		500	
L7002	Foil-Laminated Board Cover for 7002	--	12 5/16 x 6 3/16	--	--	--	0.66	21.00	--		500	
Y7021-45	4 lb. Oblong Pan	66.0	12 1/8 x 8 1/8	11 1/2 x 7 1/2	11 x 7	1 1/2	2.94	13.07	I.V.C.		150	18
L7021	Foil-Laminated Board Cover for 7021	--	12 1/16 x 8 1/16	--	--	--	0.45	14.00	--		250	

## Aluminum Pot Pies



Y405-25



434-30

## Aluminum Rounds — Full Curl



Y402-25



423-30

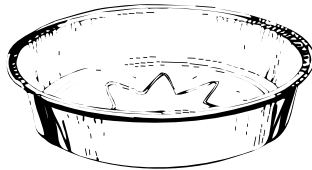

4059H

## Aluminum Rounds — Hemmed Edge

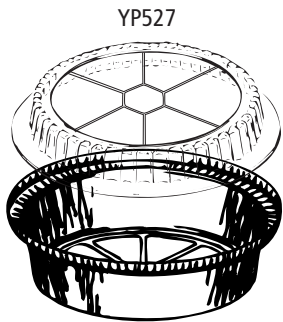

527-30

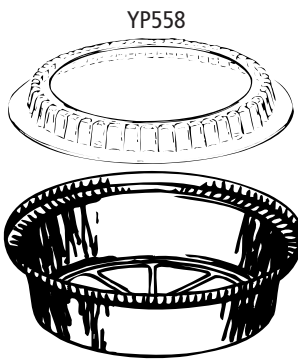

Y558-30

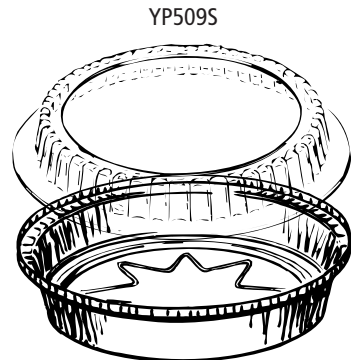

Y509-30

## Angel Food Pans

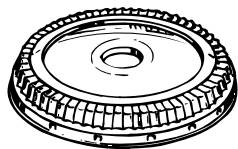

4018WPPC

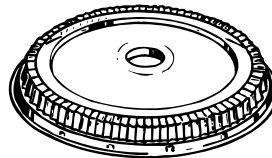

4110WP



### Aluminum Pot Pies

Product Number	Description	Capacity (fl. oz.)	Top Out	Dimensions (in inches)			Vert. Depth	Case Cube	Case Weight	Case Pack	Cases/ Unit Load
				Top In	Bottom						
Y405-25	7 oz. Casserole	7.5	5	4 <sup>3</sup> / <sub>8</sub>	3		1 <sup>9</sup> / <sub>32</sub>	1.46	7.39	750	36
434-30	10 oz. Casserole	9.5	4 <sup>3</sup> / <sub>4</sub>	4 <sup>5</sup> / <sub>16</sub>	3 <sup>7</sup> / <sub>16</sub>		1 <sup>9</sup> / <sub>16</sub>	2.30	13.84	1000	
436-35	12 oz. Casserole	12.0	5 <sup>23</sup> / <sub>32</sub>	5	3 <sup>3</sup> / <sub>8</sub>		1 <sup>19</sup> / <sub>32</sub>	2.37	18.56	1000	

### Aluminum Rounds — Full Curl

Product Number	Description	Capacity (fl. oz.)	Top Out	Dimensions (in inches)			Vert. Depth	Case Cube	Case Weight	Rim Style	Case Pack
				Top In	Bottom						
Y402-25	2 oz. Utility Cup	2.0	2 <sup>15</sup> / <sub>32</sub>	2		1 <sup>17</sup> / <sub>32</sub>	1 <sup>7</sup> / <sub>16</sub>	2.23	10.78	F.C.	2000
423-30	4 oz. Utility Cup	4.2	3 <sup>1</sup> / <sub>4</sub>	2 <sup>15</sup> / <sub>16</sub>		2 <sup>7</sup> / <sub>16</sub>	1 <sup>21</sup> / <sub>32</sub>	2.19	8.50	F.C.	1000
498-35	8" Medium Round Pan	30.5	8 <sup>17</sup> / <sub>32</sub>	7 <sup>13</sup> / <sub>16</sub>		7 <sup>1</sup> / <sub>4</sub>	1 <sup>9</sup> / <sub>32</sub>	3.70	18.09	F.C.	500
4059H	9" Medium Round Pan	43.5	9 <sup>1</sup> / <sub>32</sub>	8 <sup>17</sup> / <sub>32</sub>		7 <sup>7</sup> / <sub>8</sub>	1 <sup>15</sup> / <sub>32</sub>	4.06	16.26	F.C.	500

### Aluminum Rounds — Hemmed Edge

Product Number	Description	Capacity (fl. oz.)	Top Out	Dimensions (in inches)			Vert. Depth	Case Cube	Case Weight	Rim Style	Sleeve	Case Pack	Cases/ Unit Load
				Top In	Bottom								
527-30	7" Round - 1 <sup>1</sup> / <sub>2</sub> lb.	24.0	7 <sup>1</sup> / <sub>8</sub>	6 <sup>9</sup> / <sub>16</sub>	5 <sup>9</sup> / <sub>16</sub>		1 <sup>17</sup> / <sub>32</sub>	3.12	13.21	H.E.		500	
Y527-25	7" Round - 1 <sup>1</sup> / <sub>2</sub> lb.	24.0	7 <sup>1</sup> / <sub>8</sub>	6 <sup>9</sup> / <sub>16</sub>	5 <sup>9</sup> / <sub>16</sub>		1 <sup>17</sup> / <sub>32</sub>	1.21	4.67	H.E.		250	45
L527	Foil-Laminated Board for 527	--	7 <sup>3</sup> / <sub>32</sub>	--	--		--	0.29	8.00	H.E.		500	
YP527	Plastic Dome Cover for 527	--	7 <sup>1</sup> / <sub>16</sub>	6 <sup>3</sup> / <sub>8</sub>	5		<sup>11</sup> / <sub>16</sub>	1.05	9.79	H.E.	2/250	500	45
Y558-30	8" Round - 2 <sup>1</sup> / <sub>2</sub> lbs.	37.0	8 <sup>5</sup> / <sub>16</sub>	7 <sup>13</sup> / <sub>16</sub>	7 <sup>1</sup> / <sub>32</sub>		1 <sup>9</sup> / <sub>16</sub>	1.64	6.98	H.E.		250	30
L558	Foil-Laminated Board Cvr for 558	--	8 <sup>1</sup> / <sub>4</sub>	--	--		--	0.34	16.20	H.E.		500	
Y509-30	9" Round - 3 lbs.	46.2	8 <sup>15</sup> / <sub>16</sub>	8 <sup>3</sup> / <sub>8</sub>	7 <sup>25</sup> / <sub>32</sub>		1 <sup>21</sup> / <sub>32</sub>	2.66	12.42	H.E.		300	20
YP558	Plastic Dome Cover for 558	--	8 <sup>1</sup> / <sub>4</sub>	7.44	--		<sup>11</sup> / <sub>16</sub>	1.41	11.37		2/250	500	36
YL509	Foil-Laminated Board Cvr for 509	--	8 <sup>7</sup> / <sub>8</sub>	--	--		--	0.30	10.18	H.E.		300	160
YP509S	Plastic Shallow Dome for 509	--	8 <sup>7</sup> / <sub>8</sub>	8	7 <sup>11</sup> / <sub>16</sub>		<sup>11</sup> / <sub>16</sub>	0.65	9.24	H.E.	1/300	300	80
57310-30	10" Round	67.9	10 <sup>1</sup> / <sub>16</sub>	9 <sup>7</sup> / <sub>16</sub>	8 <sup>21</sup> / <sub>32</sub>		2 <sup>7</sup> / <sub>32</sub>	5.04	13.59	H.E.		250	

### Angel Food Pans

Product Number	Description	Capacity (fl. oz.)	Dimensions (in inches)			Vert. Depth	Case Cube	Case Weight	Case Pack	Cases/ Unit Load	
			Top Out	Top In	Bottom						
Y427-30	7" Angel Food - Metal Tube	47.2	7 <sup>11</sup> / <sub>16</sub>	7 <sup>1</sup> / <sub>4</sub>	6 <sup>11</sup> / <sub>16</sub>		2 <sup>19</sup> / <sub>32</sub>	1.27	8.06	200	45
4018WPPC	8" Angel Food Pan w/Preset Cup w/Plastic Dome	55.0	8 <sup>3</sup> / <sub>4</sub>	8 <sup>1</sup> / <sub>8</sub>	6		3 <sup>5</sup> / <sub>32</sub>	3.26	11.74	100	
4110WP	10" Medium Angel Food Pan w/Paper Tube w/Plastic Dome	74.0	10	9 <sup>3</sup> / <sub>8</sub>	7 <sup>13</sup> / <sub>16</sub>		3 <sup>1</sup> / <sub>64</sub>	3.84	14.00	100	

## Holiday Packaging

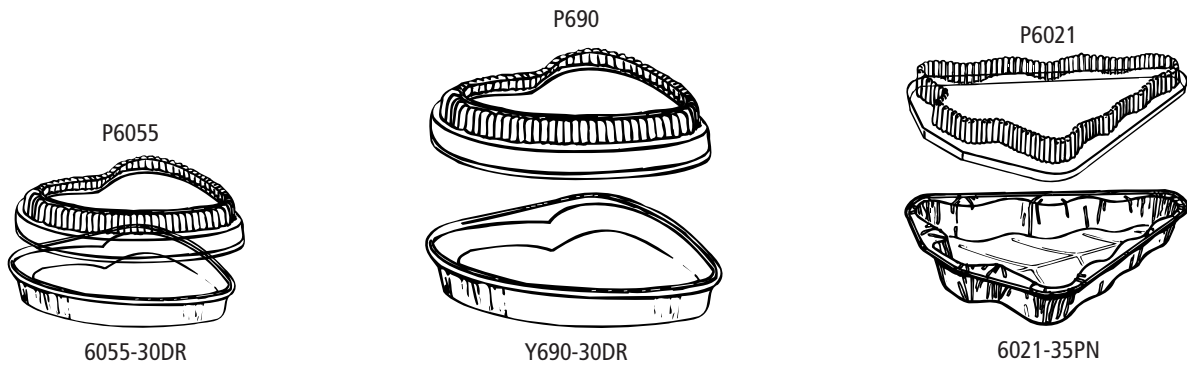

## Aluminum Muffin Pans



## Aluminum Tart Pans



## Aluminum 6" Pie Plates

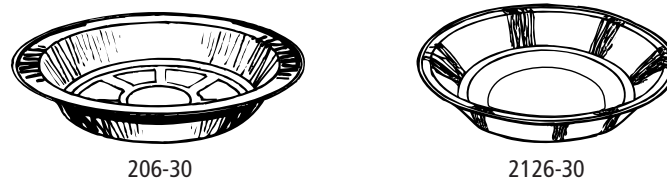

## Aluminum 8" Pie Plates

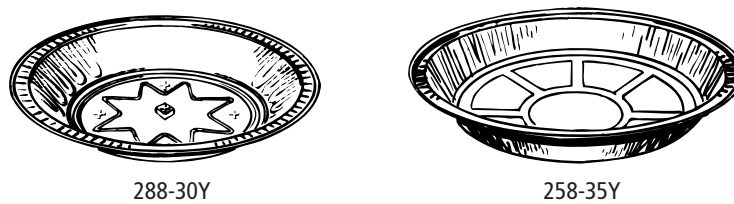

## Holiday Packaging

Product Number	Description	Package Dimensions (in inches)	Case Cube	Case Weight	Case Pack	Cases/ Unit Load
6021-35PN	Green Foil Tree Pan	11 1/2 x 9 x 1 1/2	0.93	4.93	100	
P6021	Tree Dome	11 9/16 x 9 1/16 x 13/16	1.08	4.00	100	
6055-30DR	Red Foil Small Heart Pan - 12 fl. oz.	5 3/8 x 5 9/16 x 1 1/2	0.34	2.00	100	
P6055	Small Heart Plastic Dome	5 11/16 x 5 7/8 x 3/4	0.67	2.00	100	
Y690-30DR	Red Foil Large Heart Pan - 39.5 fl. oz.	9 1/2 x 9 1/4 x 1 1/2	0.93	4.30	100	60
P690	Large Heart Deep Plastic Dome	9 7/8 x 9 15/32 x 1 1/2	1.70	5.00	100	

## Aluminum Muffin Pans

Product Number	Description	Cup Diameter	Capacity (fl. oz.)	Dimensions (in inches)			Vert. Depth	Case Cube	Case Weight	Case Pack	Cases/ Unit load
				Top Out	Top In	Bottom					
Y6548-35	4-Cavity Muffin Pan	3 1/4	5.25	8 3/8 x 8 3/8	7 1/8 x 7 1/8	6 1/4 x 6 1/4	1 7/8	2.81	13.46	200	18
69511-30	6-Cavity Muffin Pan	2 3/4	3.2	9 7/8 x 6 5/8	9 1/4 x 6	8 1/2 x 5 1/4	1 9/16	4.10	26.20	500	

## Aluminum Tart Pans

Product Number	Description	Capacity (fl. oz.)	Dimensions (in inches)			Vert. Depth	Case Cube	Case Weight	Case Pack
			Top Out	Top In	Bottom				
203-20	3 1/2" Extra Deep Tart Pan	2.5	3 3/8	3	2	7/8	1.34	7.50	2000
214-20	4 1/2" Extra Deep Tart Pan	3.7	4 11/32	3 11/16	2 11/16	57/64	2.76	12.57	2000

## Aluminum 6" Pie Plates

Product Number	Description	Capacity (fl. oz.)	Dimensions (in inches)			Vert. Depth	Case Cube	Case Weight	Case Pack
			Top Out	Top In	Bottom				
206-30	6" Medium Pie Plate	7.5	6 3/32	5 7/32	4	53/64	2.77	14.78	1000
2126-30	6" Deep Pie Plate	9.0	5 15/16	5 3/8	4	15/16	2.25	13.71	1000

## Aluminum 8" Pie Plates

Product Number	Description	Capacity (fl. oz.)	Dimensions (in inches)			Vert. Depth	Case Cube	Case Weight	Case Pack	Cases/ Unit Load
			Top Out	Top In	Bottom					
288-30Y	8" Medium Pie Plate	14.0	7 31/32	7 3/32	5 3/4	53/64	1.79	9.08	400	20
258-35Y	8" Extra Deep Pie Plate	19.5	7 7/8	7 1/8	5 1/2	1 3/16	1.63	10.97	400	20

## Aluminum 9" Pie Plates



Y269-40

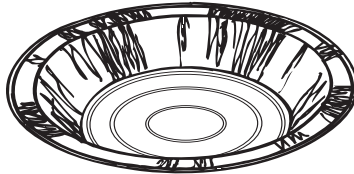

Y219-40

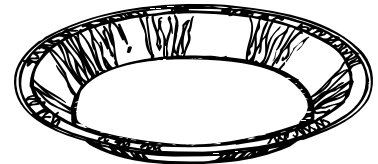

Y2399-40

## Aluminum 10" Pie Plates

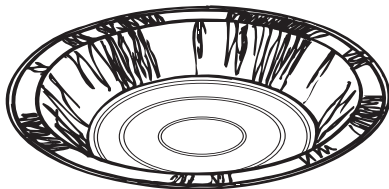

200-45Y

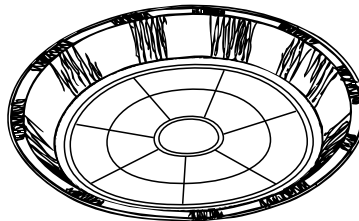

230-45Y

## Aluminum 11" and 12" Pie Plates

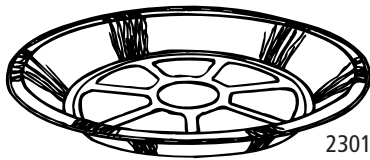

23011-50

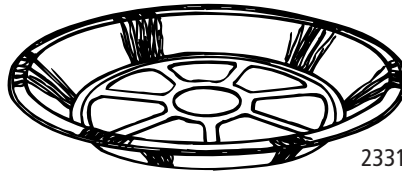

23312-50Z

## Aluminum Sheet Cake Pans

YP6042

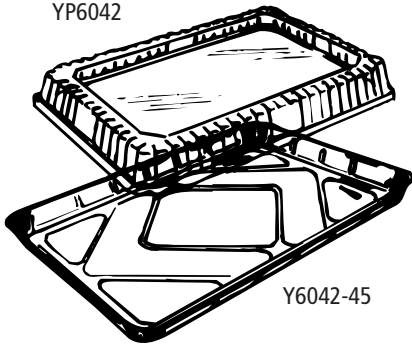

Y6042-45

P6142

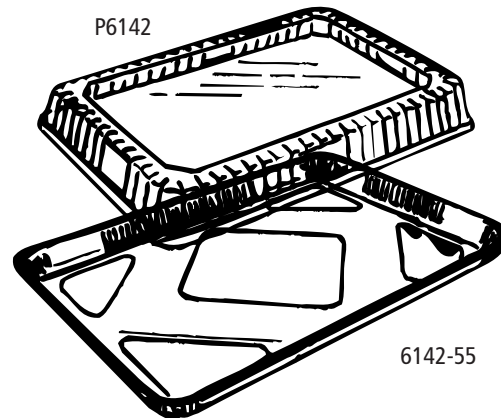

6142-55

### Aluminum 9" Pie Plates

Product Number	Description	Capacity (fl. oz.)	Dimensions (in inches)			Vert. Depth	Case Cube	Case Weight	Case Pack	Cases/ Unit Load
			Top Out	Top In	Bottom					
Y269-40	9" Medium Pie Plate	21.9	9	8 1/4	6 3/4	29/32	2.48	15.90	400	20
Y209-40	9" Medium Pie Plate	22.0	8 25/32	8 5/32	6 13/16	15/16	2.48	15.90	400	20
Y299-40	9" Deep Pie Plate	22.2	9	8	6 3/8	1 9/64	2.48	15.90	400	20
Y219-40	9" Extra Deep Pie Plate	30.0	9 1/32	8 5/16	6 5/8	1 9/32	2.48	15.90	400	20
Y2399-40	9" Extra Deep Pie Plate	29.8	9	8 3/8	6 5/8	1 7/32	2.48	15.90	400	20

### Aluminum 10" Pie Plates

Product Number	Description	Capacity (fl. oz.)	Dimensions (in inches)			Vert. Depth	Case Cube	Case Weight	Case Pack	Cases/ Unit Load
			Top Out	Top In	Bottom					
200-45Y	10" Extra Deep Pie Plate	29.5	9 5/8	8 3/4	7	1 9/64	3.17	19.93	400	16
230-45Y	10" Extra Deep Pie Plate	32.0	9 13/16	9	7 1/2	1 3/32	3.17	19.93	400	16
23110-45Y	10" Extra Deep Pie Plate	33.2	9 41/64	8 11/16	7	1 15/64	3.17	19.93	400	16

### Aluminum 11" and 12" Pie Plates

Product Number	Description	Capacity (fl. oz.)	Dimensions (in inches)			Vert. Depth	Case Cube	Case Weight	Case Pack
			Top Out	Top In	Bottom				
23011-50	11" Extra Deep Pie Plate	43.9	10 9/16	9 11/16	7 19/32	1 11/32	4.36	32.36	500
23312-50Z	12" Extra Deep Pie Plate	54.6	11 11/16	11	9	1 1/4	2.53	19.59	250

### Aluminum Sheet Cake Pans

Product Number	Description	Capacity (fl. oz.)	Top Out	Dimensions (in inches)			Vert. Depth	Case Cube	Case Weight	Sleeve	Case Pack	Cases/ Unit Load
				Top In	Bottom							
Y6042-45	1/4 Size Sheet Cake Pan	56.2	12 13/16 x 8 13/16	12 1/4 x 8 1/4	11 5/8 x 7 5/8	1 1/4	1.34	7.97	1/100	100	40	
Y6042WP	1/4 Size Sheet Cake Pan w/Dome	56.2	12 13/16 x 8 13/16	12 1/4 x 8 1/4	11 5/8 x 7 5/8	3 1/2	1.94	8.88		60	30	
YP6042	Plastic Dome for 6042	--	13 1/4 x 9 1/4	12 3/8 x 8 3/8	11 7/16 x 7 7/16	2 1/4	1.95	8.96	1/100	100	30	
6142-55	1/2 Size Sheet Cake Pan	116.0	17 5/8 x 12 13/16	17 1/16 x 12 1/4	16 7/16 x 11 5/8	1 1/4	2.67	17.72		100		
P6142	Plastic Dome for 6142	--	18 1/32 x 13 7/32	17 3/16 x 12 3/8	16 1/4 x 11 7/16	2 1/4	3.29	17.00	1/100	100	24	
6006-80	Full Size Sheet Cake Pan	240.0	25 13/16 x 17 13/16	24 13/16 x 16 13/16	24 1/4 x 16 1/4	1 11/32	2.45	14.97		25		

## ClearView™ SmartLock® Hingeware



YCI8-934S



YCI8-0934

## ClearView™ SmartLock® Containers



YCI8-1050



YCI8-1160



YCI8-1045



YCI8-1120



YCI8-1123

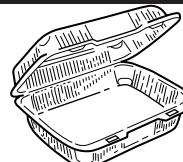

YCI8-1110

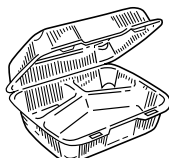

YCI8-1113



YCI8-2025



YCI8-2030

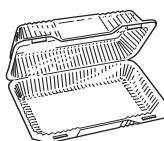

YCI8-2035

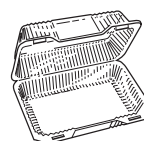

YCI8-2040



YCI8-1030



YCI8-3035

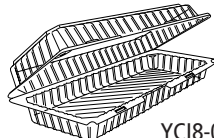

YCI8-0960

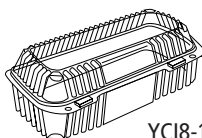

YCI8-1049

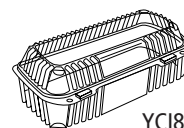

YCI8-1048

## ClearView SmartLock® Bakery Containers

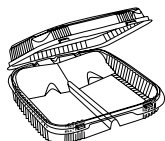

YCI8-1224



YCI8-3011

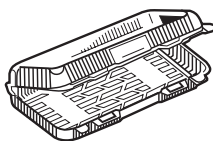

YCI8-3025



YCI8-9060



YCI8-9360

## ClearView™ Roseware™ Bowls

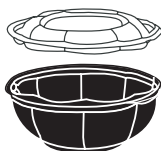

YEH8-7024

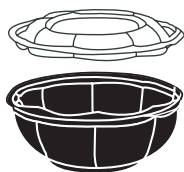

YEH8-7035

## EarthChoice® PLA Hinged & Deli Containers



YLI8-1160-0000



YLI8-1120-0000

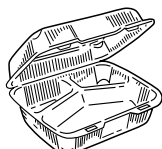

YLI8-1123-0000



YLI8-6008-0000



YLI8-6016-0000

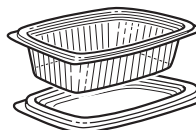

YLI8-6024-0000

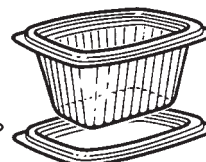

YLI8-6032-0000

### ClearView™ SmartLock® Hingeware

Product Number	Description	Capacity (fl. oz.)	Top Out	Dimensions (in inches)		Cube	Cs. Wt.	Sleeve	Case Pack	Cases/ Unit Load
				Top In	Bottom					
YC18-0934	Mini-Loaf Hingeware	--	7 3/4 x 4 1/2 x 3 1/2	7 x 3 5/8 x 3 3/8	7 3/4 x 8 15/16 x 1 7/8	2.44	12.86	4/75	300	24
YC18-9345	Shallow Dome Mini Loaf Hingeware	6.5 oz.	7 3/4 x 4 1/2 x 2 3/16	7 x 3 5/8 x 2 1/8	7 3/4 x 8 15/16 x 1 17/32	3.06	12.77	4/75	300	18

### ClearView™ SmartLock® Containers

Product Number	Description	Capacity (fl. oz.)	Dimension (in inches)	Cube	Case Approx. Wt.	Sleeve	Packing Case	Cases/ Unit Load
YC18-1050	Clear 5" Hinged Lid w/1-Cmpt. Tray	11 oz.	5 1/4 x 5 1/4 x 2 1/2	1.75	11.24	3/125	375	36
YC18-1160	Clear 6" Hinged Lid w/1-Cmpt. Tray	20 oz.	5 3/4 x 6 x 3	2.92	19.26	4/125	500	18
YC18-1045	Clear Single Tab Hotdog Container	--	6 1/2 x 2 3/4 x 2 1/4	1.58	8.27	2/125	250	36
YC18-1048	Clear 7 1/2" Hoagie Package	23 oz.	8 1/2 x 4 x 3 1/4	1.70	11.06	2/125	250	30
YC18-1049	Clear 9" Hoagie Package	27 oz.	9 1/4 x 4 1/2 x 3	1.98	12.76	2/125	250	30
YC18-1120	Clear Medium Hinged Lid w/1-Cmpt. Tray	49 oz.	8 13/64 x 8 11/32 x 2 29/32	2.13	15.60	1/200	200	24
YC18-1123	Clear Medium Hinged Lid w/3-Cmpt. Tray	5 oz.(S) - 14 oz. (L)	8 13/64 x 8 11/32 x 2 29/32	2.13	15.80	1/200	200	24
YC18-1110	Clear Large Hinged Lid w/1-Cmpt. Tray	62 oz.	9 7/32 x 8 7/8 x 2 29/32	2.61	18.13	2/100	200	20
YC18-1113	Clear Large Hinged Lid w/3-Cmpt. Tray	6.7 oz.(S) - 24 oz.(L)	9 7/32 x 8 7/8 x 2 29/32	2.61	18.35	2/100	200	20
YC18-2025	Clear Small Hinged Lid	33 oz.	6 23/32 x 8 35/64 x 2 21/32	2.23	16.94	2/140	280	27
YC18-2030	Clear Hinged Lid w/1-Cmpt. Tray (SS)	22 oz.	9 1/4 x 6 1/4 x 2	1.99	13.46	2/100	200	30
YC18-2035	Clear Hinged Lid w/1-Cmpt. Tray (DS)	36 oz.	9 1/4 x 6 1/4 x 2 5/8	1.99	13.45	2/100	200	30
YC18-2040	Clear Hinged Lid w/1-Cmpt. Tray (DD)	36 oz.	9 1/4 x 6 1/4 x 3 1/4	1.99	13.58	2/100	200	30
CI8-1030	Clear Medium Hinged Lid Container - Deep	39.6 oz.	8 5/8 x 7 1/8 x 3	2.70	16.45	2/125	250	18
YC18-3035	Clear Utility (DS)	82 oz.	10 3/4 x 9 1/4 x 3 1/2	2.38	18.40	2/75	150	24
YC18-0960	Foot-Long Hingeware	53.7 oz.	14 5/8 x 5 5/8 x 3 1/4	4.57	20.00	2/125	250	12

### ClearView SmartLock® Bakery Containers

Product Number	Description	Capacity (fl. oz.)	Dimensions (in inches)	Cube	Case Approx. Wt.	Sleeve	Packing Case	Cases/ Unit Load
YC18-1124	ClearView™ SmartLock® Cookie Container	49 oz.	8 13/64 x 8 11/32 x 2 29/32	2.07	15.42	1/200	200	24
YC18-1224	ClearView™ SmartLock® Cookie Container	N/A	8 13/34 x 8 11/32 x 2 5/16	2.07	15.42	1/200	200	24
YC18-3011	Clear Pound Cake Hinged Lid	31 oz.	9 1/8 x 5 1/2 x 3 3/8	2.11	18.18	2/145	290	24
YC18-3025	Clear Large Strudel Hinged Lid	44 oz.	6 55/64 x 13 21/64 x 2 1/4	1.44	10.23	1/105	105	36
YC18-9060	Clear Cup Cake/Sm. Muffin 6-Cmpt. Tray - Shallow	N/A	9 3/4 x 6 7/8 x 3	2.78	16.10	2/110	220	18
YC18-9360	Clear Cup Cake/Sm. Muffin 6-Cmpt. Tray - Deep (Stacking Lugs)	N/A	9 3/4 x 6 7/8 x 3 3/4	2.95	18.06	2/125	250	18

### ClearView™ Roseware™ Bowls

Product Number	Description	Capacity (fl. oz.)	Dimensions (in inches)		Vert. Depth	Cube	Case Approx. Wt.	Sleeve	Case Pack	Cases/ Unit Load	
			Top Out	Top In	Bottom						
YEH8-7024	24 oz. Black Bowl Combo w/Lid	24.0	8.13	7.63	4.5	1.88	3.98	19.69	2/110	220	12
YEH8-7035	35 oz. Black Bowl Combo w/Lid	35.0	8.13	7.63	4.5	2.44	3.98	19.69	2/110	220	12

### EarthChoice® PLA Hinged & Deli Containers

Item#	Description	Capacity	Dimensions	Cube	Case Weight	Sleeve	Case Pack	Cases/ Unit Load
<b>Clear Hinged Lid Containers</b>								
YL18-1160-0000	EarthChoice® 6 in. Clear Hinged Container	20	5 3/4 x 6 x 3	3.33	22.80	4/125	500	16
YL18-1120-0000	EarthChoice® Medium 1-Cmpt. Clear Hinged Cont.	49	8 13/64 x 8 11/32 x 2 29/32	2.06	17.93	2/100	200	24
YL18-1123-0000	EarthChoice® Medium 3-Cmpt. Clear Hinged Cont.	5 (sm), 14 (lg)	8 13/64 x 8 11/32 x 2 29/32	2.06	17.93	2/100	200	24
<b>Clear Deli Containers &amp; Lids</b>								
YL18-6008-0000	EarthChoice® 8 oz. Clear Deli Container w/Lid	8	5.9 x 4.9 x 1.25	2.26	10.03	5/51	255	24
YL18-6016-0000	EarthChoice® 16 oz. Clear Deli Container w/Lid	16	5.9 x 4.9 x 2.75	2.56	11.82	5/51	255	24
YL18-6024-0000	EarthChoice® 24oz. Clear Deli Container w/Lid	24	7.5 x 6.5	2.68	10.73	2/100	200	18
YL18-6032-0000	EarthChoice® 32 oz. Clear Deli Container w/Lid	32	7.5 x 6.5 x 2.70	2.93	13.85	4/50	200	18

\* Item may not be available in all regions. Please contact your Pactiv sales representative for order minimum and lead time.

## Showcase® Designer® Bowls

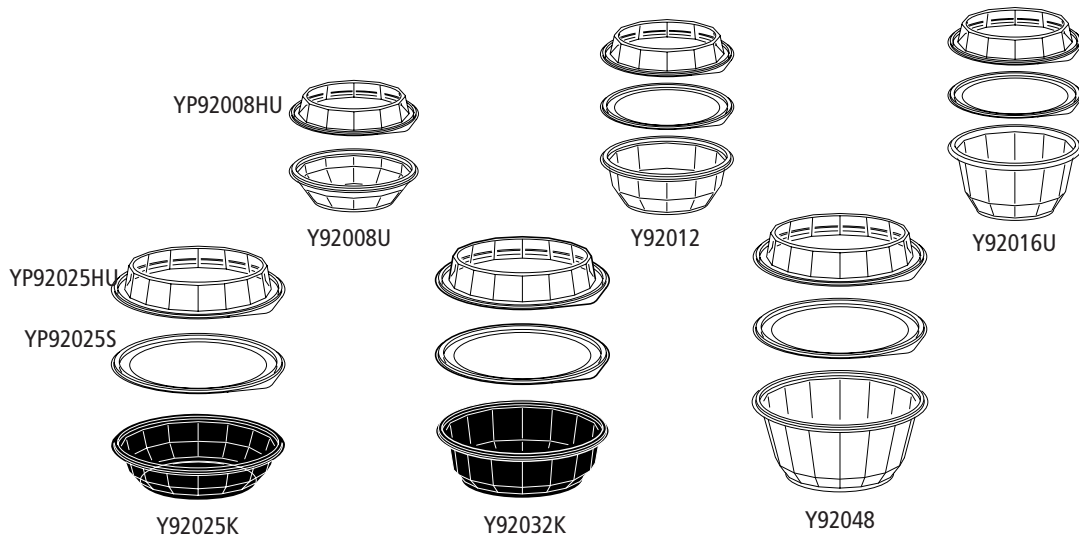

## ClearView™ TrayMates™ Domes

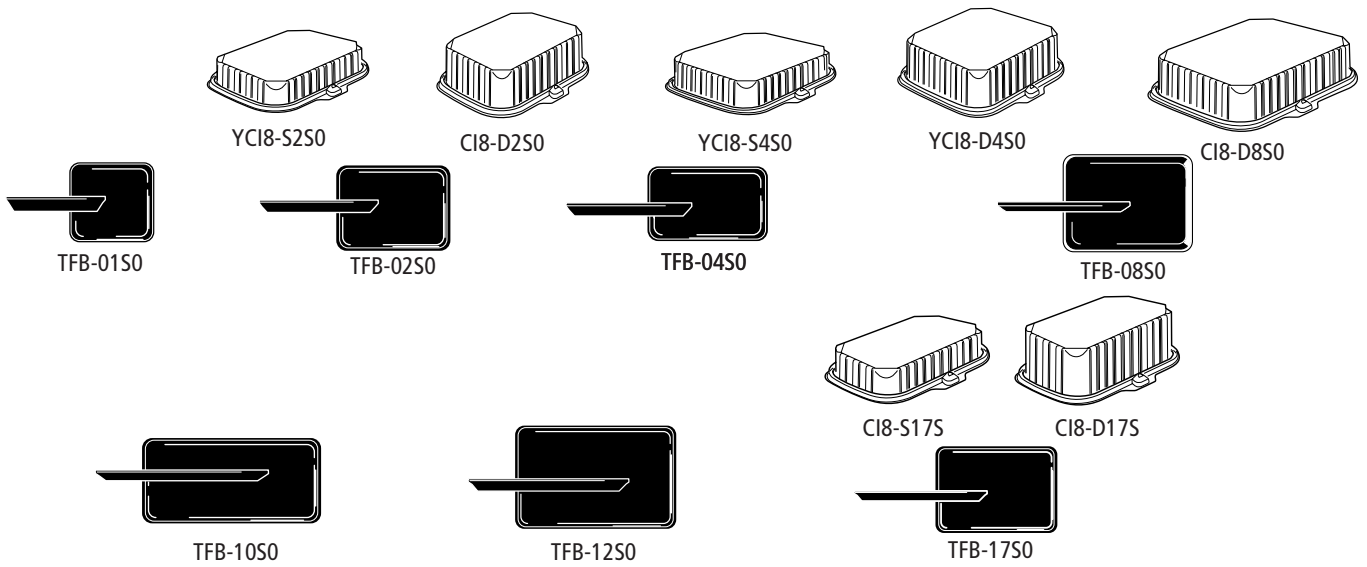

## SmartLock® Showcake® Packaging — Black Base

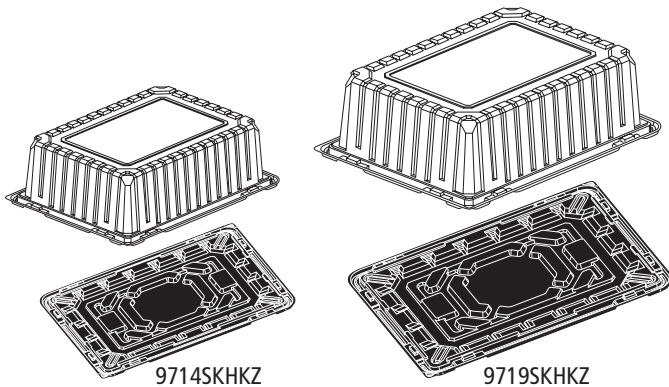



### Showcase® Designer® Bowls

Product Number	Description	Capacity (fl. oz.)	Dimensions (in inches)			Vert. Depth	Case Cube	Case Approx. Wt.	Sleeve	Case Pack	Cases/ Unit Load
			Top	Out	Top In						
Y92008U	8 oz. Clear Bowl	8.0	5 15/32	4 25/32	3 3/8	1 25/32	1.44	4.51	4/75	300	32
Y92012	12 oz. Clear Bowl	12.0	5 15/32	4 25/32	3 5/16	1 7/8	1.58	4.79	4/75	300	32
Y92016U	16 oz. Clear Bowl	16.0	5 15/32	4 25/32	3 1/16	2 39/64	1.66	6.65	4/75	300	32
YP92008HU	Dome Lid	--	5 15/32	--	--	15/16	1.23	4.48	4/75	300	36
Y92025U	24 oz. Clear Shallow Bowl	24.0	7 15/32	6 25/32	5 9/32	1 51/64	3.06	9.49	4/75	300	18
Y92025K	24 oz. Black Shallow Bowl	24.0	7 15/32	6 25/32	5 7/64	1 51/64	3.06	10.76	4/75	300	18
Y92032U	32 oz. Clear Bowl	32.0	7 15/32	6 25/32	5 7/64	2 5/16	3.05	11.00	6/50	300	18
Y92032K	32 oz. Black Bowl	32.0	7 15/32	6 25/32	4 47/64	2 5/16	3.03	11.94	6/50	300	18
Y92048	48 oz. Clear Bowl	48.0	7 15/32	6 25/32	4 7/16	3 3/16	3.07	14.72	4/75	300	18
YP92025HU	Dome Lid	--	7 15/32	--	--	31/64	1.97	9.33	4/75	300	27
YP92025S	Flat Lid	--	7 15/32	--	--	17/64	2.96	8.20	4/75	300	18
Y92032SCHU	32 oz. Clear Bowl Combo w/Dome	32.0	7 15/32	6 25/32	5 3/32	2 5/16	3.35	16.20	2/100	200	15
Y92164SCU	64 oz. Clear Bowl Combo w/Snap-On Lid	64.0	7 15/32	6 25/32	4 7/16	4 31/64	3.05	10.53	2/75	150	18

### ClearView™ TrayMates™ Domes

Product Number	Description	Dimension (in inches)	Cube	Case Approx. Wt.	Packing Sleeve	Case	Cases/ Unit Load
C18-D250	Deep Dome for Pactiv 2 and 2S Foam Trays	8.2 x 5.7 x 2.1	3.54	12.00	4/63	252	18
YC18-S450	Shallow Dome for Pactiv 4S Foam Trays	9.1 x 7.1 x 1.5	4.45	11.34	4/63	252	12
YC18-D450	Deep Dome for Pactiv 4S Foam Trays	9.1 x 7.1 x 2.1	4.45	14.32	4/63	252	12
C18-D850	Deep Dome for Pactiv 8S Foam Trays	10 x 8 x 2.1	6.13	17.52	4/63	252	8
C18-S175	Shallow Dome for Pactiv 17S Foam Trays	8.3 x 4.8 x 1.5	3.17	10.00	4/63	252	16
C18-D175	Deep Dome for Pactiv 17S Foam Trays	8.3 x 4.8 x 2.1	3.17	10.00	4/63	252	16

### SmartLock® Showcake® Packaging — Black Base

Product Number	Description	Dimensions (in inches)		Finished Cake Size	Case Cube	Case Weight	Case Pack	Cases/ Unit Load
		Inside	Outside					
9714SKHKZ	1/4 Sheet Cake Package w/Black Base - Deep	14 x 10 x 4 1/2	15 3/8 x 11 3/8 x 5	1/4" Sheet Cake single layer with 2" figurines; OR 2 layer filled	3.18	15.75	50 ea.	16
9719SKHKZ	1/2 Sheet Cake Package w/Black Base - Deep	19 x 14 x 4 1/2	20 3/8 x 15 3/8 x 5	1/2" Sheet Cake single layer with 2" figurines; OR 2 layer filled	2.74	15.43	25 ea.	18

SmartLock® Showcake® Packaging — Clear Base

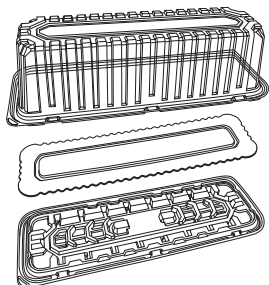

Y9517SKZ

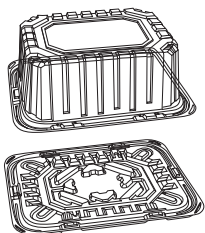

Y9518SKZ

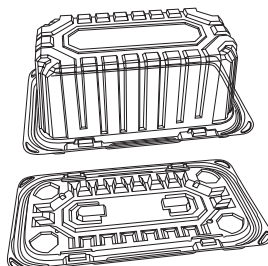

Y9519SKZ

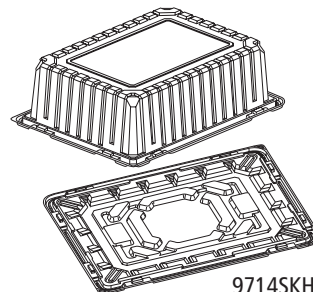

9714SKHZ

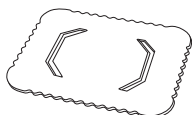

609518B

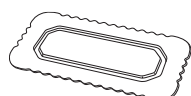

609519B

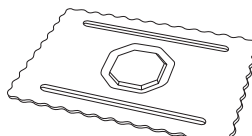

609714B

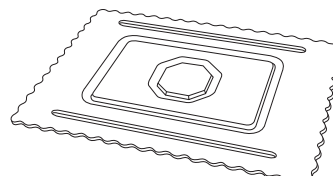

609719B

Showcake® Packaging — Clear Domes, Clear Bases



Y92164SCU

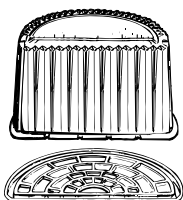

95045KU

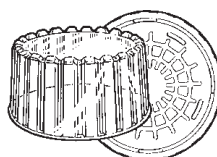

YCI8-9701

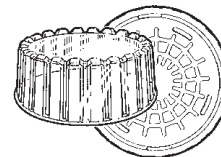

YCI8-9702

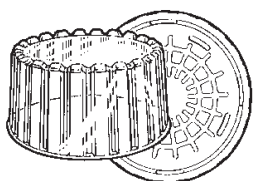

YCI8-9801

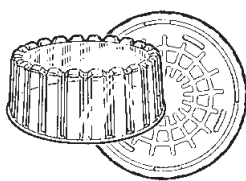

YCI8-9802

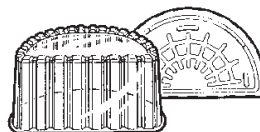

YCI8-9851

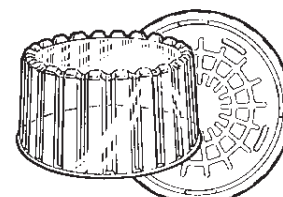

YCI8-9901

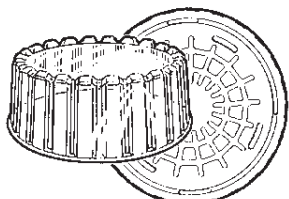

YCI8-9902

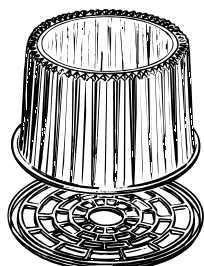

Y9510SKHU

**SmartLock® Showcake® Packaging — Clear Base**

Product Number	Description	Package Dimensions (in inches)		Finished Cake Size	Case		Sleeve	Case Pack	Cases/ Unit Load
		Inside	Outside		Cube	Weight			
Y9517SKZ	Designer Bar Cake Package W/Foam Cake Board	18.46 x 4.71 x 4.68	21.02 x 7.27 x 5.13 19.72 x 4.97 (foam board)	17" x 4" 2 Layer	1.96	8.11	1/25	25	32 25
Y9518SKZ	Junior Bar Cake Package	9.16 x 7.15 x 3.9	11.59 x 9.58 x 4.36	1/8 Sheet Cake 1 or 2 Layer	3.41	18.48	2/55 ea.	110 ea.	16
609518B	Foam Cake Board for 9518SK		9.9 x 7.896		1.05	4.66		100 ea.	
Y9519SKZ	Bar Cake Package	9.37 x 4.64 x 4.06	11.84 x 7.09 x 4.51	9" x 4" Bar Cake or Jelly Roll	2.80	13.15	2/55 ea.	110 ea.	18
609519B	Foam Cake Board for 9519SK		10.133 x 5.384		0.86	3.50		100 ea.	
9714SKHZ	1/4 Sheet Cake Package - Deep with 2" Figurines; OR 2 Layer Filled	13.18 x 9.3 x 4.49	15.72 x 11.84 x 5.0	1/4 Sheet Cake Single Layer	3.18	15.75	1/50 ea.	50 ea.	16
609714B	Foam Cake Board for 9714SK		13.84 x 9.9		4.27	15.54		200 ea.	
9719SKHZ	1/2 Sheet Cake Package - Deep with 2" Figurines; OR 2 Layer Filled	18.05 x 13.05 x 4.55	20.55 x 15.59 x 5.0	1/2 Sheet Cake Single Layer	3.23	13.79	1/25 ea.	25 ea.	18
609719B	Foam Cake Board for 9719SK		18.8 x 13.8		4.09	15.06		100 ea.	

\* Accepts PACTIV Pan 6042

SHOWCAKE® Packages produced under one or more of the following patents: 4,741,452; D298,791; 5,018,624; 4,863,058.

**Showcake® Packaging — Clear Domes, Clear Bases**

Product Number	Description	Dimensions (in inches)			Finished Cake Size	Case		Packing		Cases/ Unit Load
		Inside	Outside	Interior Depth		Cube	Approx Wt.	Sleeve	Case	
Y92164SCU	Mini-Cake Package	6 <sup>25</sup> / <sub>32</sub>	7 <sup>15</sup> / <sub>32</sub>	4 <sup>3</sup> / <sub>8</sub>	4" Cake w/lcing	3.05	10.53	2/75 ea.	150 ea.	18
9504SKU	Half-Cake Package	9.0	10 <sup>1</sup> / <sub>2</sub>	4 <sup>5</sup> / <sub>8</sub>	One Half 7" or 8" dia.	2.78	10.00	4/25 ea.	100 ea.	21
YCI8-9701	7" Cake w/Deep Dome for 2-3 Layer Cake	8.0	9.0	4 <sup>1</sup> / <sub>2</sub>	7.2	2.66	10.12	2/50 ea.	100 ea.	20
YCI8-9702	7" Cake w/Shallow Dome for 1-2 Layer Cake	8.0	9.0	2 <sup>3</sup> / <sub>4</sub>	7.2	2.47	15.94	1/100 ea.	100 ea.	20
YCI8-9801	8" Cake w/Deep Dome for 2-3 Layer Cake	9 <sup>1</sup> / <sub>4</sub>	10 <sup>1</sup> / <sub>4</sub>	5.0	8.5	3.28	13.01	2/50 ea.	100 ea.	16
YCI8-9802	8" Cake w/Shallow Dome for 1-2 Layer Cake	9 <sup>1</sup> / <sub>4</sub>	10 <sup>1</sup> / <sub>4</sub>	3 <sup>5</sup> / <sub>8</sub>	8.5	3.28	12.53	2/50 ea.	100 ea.	16
YCI8-9851	8" Half Cake w/Deep Dome for 2-3 Layer Cake	9 <sup>1</sup> / <sub>4</sub>	10 <sup>1</sup> / <sub>4</sub>	4 <sup>7</sup> / <sub>8</sub>	8.5	2.28	9.84	2/50 ea.	100 ea.	24
YCI8-9901	9" Cake w/Deep Dome for 2-3 Layer Cake	10.0	11.1	5 <sup>1</sup> / <sub>4</sub>	9.3	3.88	14.91	2/45 ea.	90 ea.	12
YCI8-9902	9" Cake w/Shallow Dome for 1-2 Layer Cake.	10.0	11.1	3 <sup>5</sup> / <sub>8</sub>	9.3	3.66	15.10	2/45 ea.	90 ea.	12
Y9510SKHU	10" Cake Package - Deep	10 <sup>3</sup> / <sub>4</sub>	12.0	5.0	9" or 10" dia. 2 or 3 Layer	2.93	10.72	1/55 ea.	55 ea.	18
Y9510SKSU	10" Cake Package - Shallow	10 <sup>3</sup> / <sub>4</sub>	12.0	3 <sup>1</sup> / <sub>4</sub>	9" or 10" dia. 1 or 2 Layer	2.92	9.83	1/55 ea.	55 ea.	18

**Showcake Packaging — Clear Domes, Black Bases**

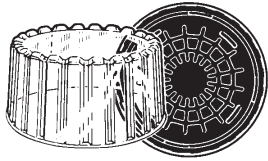

YEH8-9701

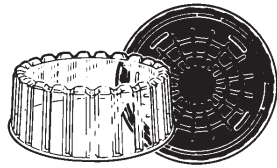

YEH8-9702

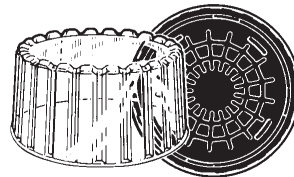

YEH8-9801

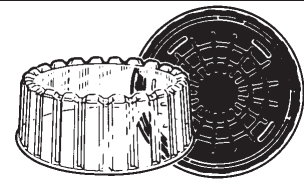

YEH8-9802

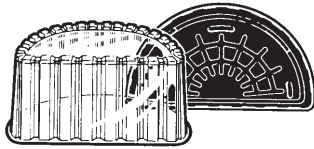

YEH8-9851

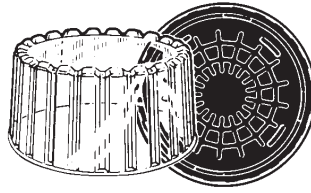

YEH8-9901

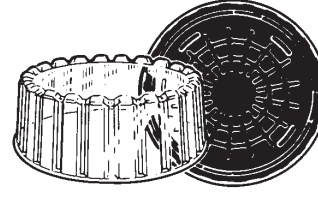

YEH8-9902

**Cake Circles — Foam**



60625



60725



60800

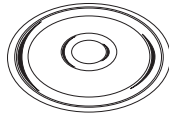

60825

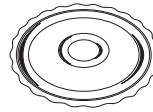

60800Z

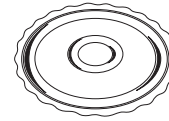

60900Z

**Showpie® Packaging — One-Piece Hinged**

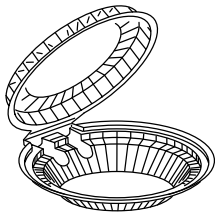

9706S

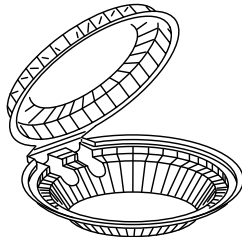

Y9708S

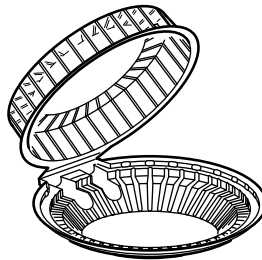

Y9709H

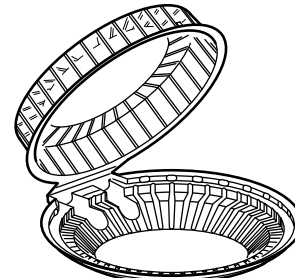

9710H

**Showpie Packaging — Two-Piece: Black Base/Clear Dome**

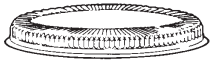

YEH8-9030



YEH8-9130



YEH8-9035

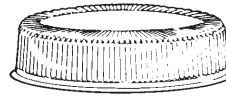

YEH8-9135



EH8-9045

**Showpie Hinged Wedges**

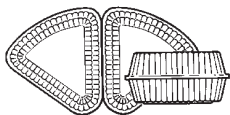

YCI8-9006

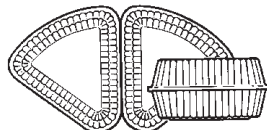

CI8-9019

### Showcake Packaging — Clear Domes, Black Bases

Product Number	Description	Dimensions (in inches)			Finished Cake Size	Case Cube	Case Approx Wt.	Packing Sleeve	Case	Cases/ Unit Load
		Inside	Outside	Interior Depth						
YEH8-9701	7" Cake w/Deep Dome for 2-3 Layer Cake	8.0	9.0	4 1/2	7.2	2.66	10.12	2/50 ea.	100 ea.	20
YEH8-9702	7" Cake w/Shallow Dome for 1-2 Layer Cake	8.0	9.0	2 3/4	7.2	2.47	15.70	1/100 ea.	100 ea.	20
YEH8-9801	8" Cake w/Deep Dome for 2-3 Layer Cake	9 1/4	10 1/4	5.0	8.5	3.28	14.32	2/50 ea.	100 ea.	16
YEH8-9802	8" Cake w/Shallow Dome for 1-2 Layer Cake	9 1/4	10 1/4	3 5/8	8.5	3.28	13.01	2/50 ea.	100 ea.	16
YEH8-9851	8" Half Cake w/Deep Dome for 2-3 Layer Cake	9 1/4	10 1/4	4 7/8	8.5	2.28	9.97	2/50 ea.	100 ea.	16
YEH8-9901	9" Cake w/Deep Dome for 2-3 Layer Cake	10	11.1	5 1/4	9.3	3.88	15.41	2/45 ea.	90 ea.	12
YEH8-9902	9" Cake w/Shallow Dome for 1-2 Layer Cake	10	11.1	3 5/8	9.3	3.65	14.71	2/45 ea.	90 ea.	12

### Cake Circles — Foam

Product Number	Description	Tray Dimension	Case		Case Pack
			Cube	Approx Wt.	
60625	6 1/4" White Foam Cake Circle	6 1/4" Dia.	3.80	8.30	1000
60725	7 1/4" White Foam Cake Circle	7 1/4" Dia.	5.30	10.70	1000
60800	8" White Foam Cake Circle	8" Dia.	3.26	5.58	500
60825	8 1/4" White Foam Cake Circle	8 1/4" Dia.	4.10	8.80	500
60800Z	8" White Foam Cake Circle (scalloped)	8" Dia.	3.98	8.00	500
60900Z	9" White Foam Cake Circle (scalloped)	9" Dia.	4.99	10.34	500

### Showpie® Packaging — One-Piece Hinged

Product Number	Description	Dimensions (in inches)			Vert. Depth	Case Cube	Case Weight	Case Sleeve	Case Pack	Cases/ Unit Load
		Top Out	Top In	Bottom						
9706S	6" Shallow Dome	7 1/4	6	4	1 7/8	2.20	7.00	1/100	100	18
Y9708H	8" Deep Dome	9 1/4	8	5 1/2	3 1/8	2.70	9.69	1/85	85	20
Y9708S	8" Shallow Dome	9 1/4	8	5 1/2	2 1/16	2.70	9.69	1/85	85	20
Y9709H	9" Deep Dome	10 1/4	9	6 3/4	3 1/4	4.40	16.62	2/60	120	12
Y9709S	9" Shallow Dome	10 1/4	9	6 3/4	2 1/8	4.56	16.66	2/60	120	12
9710H	10" Deep Dome	11	9 1/2	7 1/2	3 1/4	4.89	17.70	2/50	100	12
9710S	10" Shallow Dome	11	9 1/2	7 1/2	2 1/8	4.52	17.46	2/50	100	12

### Showpie Packaging — Two-Piece: Black Base/Clear Dome

Product Number	Description	Capacity (fl. oz.)	Dimensions (in inches)			Interior Depth	Case Cube	Case Weight	Case Sleeve	Case Pack	Cases/ Unit Load
			Top Out	Top In	Bottom						
YEH8-9030	8" Pie Container w/Shallow Dome	26.5 oz.	9 1/4	8	5 1/2	2.0	2.62	11.01	2/80 ea.	160 ea.	20
YEH8-9130	8" Pie Container w/Deep Dome	26.5 oz.	9 1/4	8	5 1/2	3 5/8	2.69	11.56	2/60 ea.	120 ea.	20
YEH8-9035	9" Pie Container w/Shallow Dome	36 oz.	10 3/8	9	6 3/4	2.0	3.01	12.12	2/63 ea.	126 ea.	16
YEH8-9135	9" Pie Container w/Deep Dome	36 oz.	10 3/8	9	6 3/4	3 5/8	3.26	14.61	2/63 ea.	126 ea.	16
EH8-9045	10" Pie Container w/Shallow Dome	42 oz.	11 1/4	10	7 1/2	2.0	3.17	14.37	2/63 ea.	125 ea.	16

### Showpie Hinged Wedges

Product Number	Description	Holds/Capacity	Dimensions (in inches)		Interior Depth	Case Cube	Case Weight	Case Sleeve	Case Pack	Cases/ Unit Load
			Back to Front	Corner to Corner						
YC18-9006	6" Hinged Pie Wedge	7 oz.	4 1/2	4 1/2 x 4 1/2	2 1/2	3.00	9.64	6/85	510	18
CI8-9019	9" Hinged Pie Wedge - Deep	9 oz.	5 3/8	5.4 x 5.4	2 3/8	4.72	11.99	8/63	500	12

## APET Round Cake Packaging – 4" & 5"



## APET Round Cake Packaging – 8"

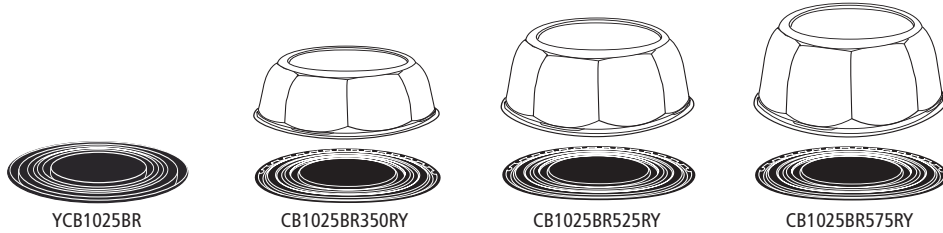

## APET Round Cake Packaging – 9"

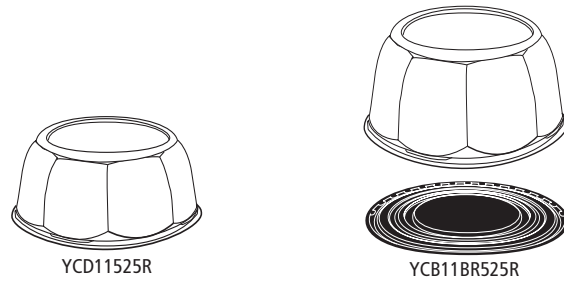

## APET Round Cake Packaging – 10" & 11"

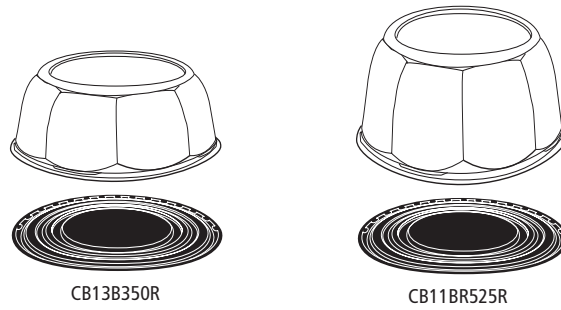

## APET Half Round Cake Packaging

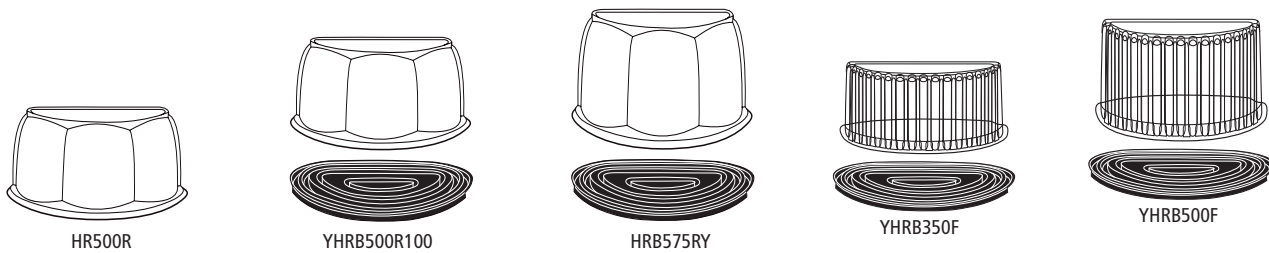

### APET Round Cake Packaging – 4" & 5"

Product Number	Description	Case Pack	Case Weight	Case Cube
<b>RoseDome™</b>				
CB675B450R	6" Black Base & 4.5" RoseDome™ - Combo Pack	160	18.21	3.58
CB675B625R		160	17.82	3.91
CB675BCC450R		160	18.21	3.58

### APET Round Cake Packaging – 8"

Product Number	Description	Case Pack	Case Weight	Case Cube
<b>RoseDome™</b>				
YCB1025BR	10.25" Black Base for 8"- 9" Cake	200	15.95	5.75
CB1025BR350RY	3.5" Rosedome with 10.25" Black Base for 8"- 9" Cake - Combo Pack	100	18.72	5.30
CB1025BR525RY	5.25" Rosedome with 10.25" Black Base for 8"- 9" Cake - Combo Pack	100	23.98	6.07
CB1025BR575RY	5.75" Rosedome with 10.25" Black Base for 8" Cake - Combo Pack	100	24.49	6.07

### APET Round Cake Packaging – 9"

Product Number	Description	Case Pack	Case Weight	Case Cube
<b>RoseDome™</b>				
YCD11525R	5.25" RoseDome™ for 9" Cake	100	22.89	4.53
YCB11BR525R	5.25" RoseDome™ with Black Base for 9" Cake - Combo Pack	50	17.01	4.53

### APET Round Cake Packaging – 10" & 11"

Product Number	Description	Case Pack	Case Weight	Case Cube
<b>RoseDome™</b>				
CB13B350R	3.5" RoseDome™ with Black Base for 10"- 11" Cake - Combo Pack	50	20.84	4.19
CB13B575R	5.25" RoseDome™ with Black Base for 10"- 11" Cake - Combo Pack	50	CB135	
CD13575R				

### APET Half Round Cake Packaging

Product Number	Description	Case Pack	Case Weight	Case Cube
<b>Rosedome™</b>				
YHRB	8" Black Half Round Cake Base	150	10.25	4.33
HR500R	5" Rosedome™ for 8" Half Round Cake	200	17.19	4.19
YHRB500R100	5" Rosedome™ with Black Base for 8" Half Round Cake - Combo Pack	100	15.99	4.33
HRB575RY	5.75" Rosedome™ with Black Base for 8" Half Round Cake - Combo Pack	100	16.50	4.19
<b>Fluted</b>				
YHRB	8" Black Half Round Cake Base	150	10.25	4.33
HRB350F	3.5" Fluted Dome with Black Base for 8" Half Round Cake - Combo Pack	100	14.60	3.30
YHRB500F	5" Fluted Dome with Black Base for 8" Half Round Cake - Combo Pack	60	8.49	1.84

## APET Sheet Cake Packaging - 1/8

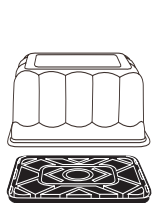

YESB425LR

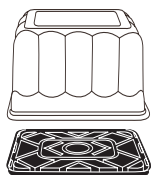

YESB500R

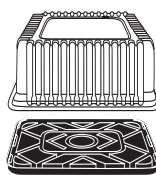

YESB350FTAB

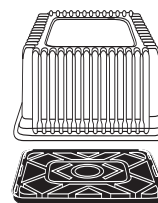

YESB500FTAB

## APET Sheet Cake Packaging - 1/4



YQSBSTAB

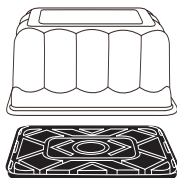

YQSB425LRLTAB

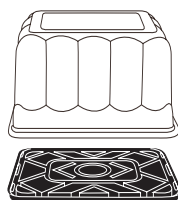

YQSB500RSTAB

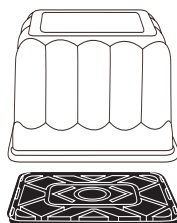

YQSB600LRLTAB

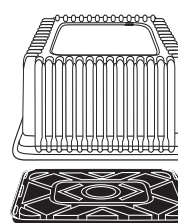

YQSB500FSTAB

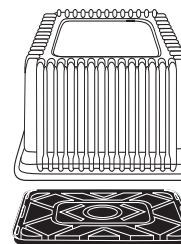

YQSB600FSTAB

## APET Sheet Cake Packaging - 1/2

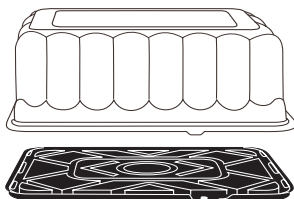

YHSB500R1TAB



YHSB1TAB60

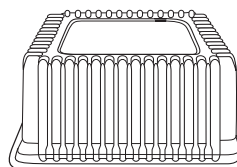

YHS500F1TAB

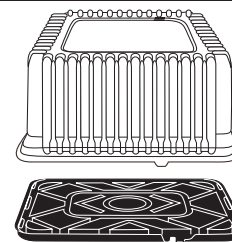

YHSB500F1TAB

## APET Bar Cake Packaging

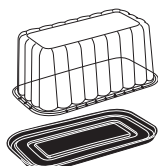

YBCB425R

## Clear Advantage™ SmartLock® Bakery/Deli Hingeware – APET



YCASH1050



YCASH1160

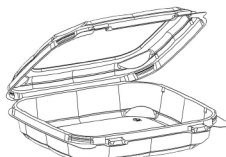

OCASH1220



OCASH1120



OCASH1124

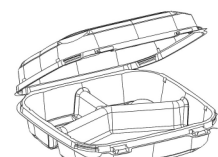

OCASH1123

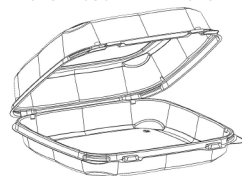

OCASH1110

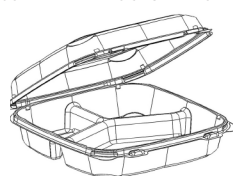

OCASH1113



OCASH3025



### APET Sheet Cake Packaging - 1/8

Product Number	Description	Case Pack	Case Weight	Case Cube
<b>Rosedome™</b>				
YESB425LRTAB	4.25" Rosedome™ with Label Panel with Black Base for 1/8 Sheet Cake - Combo Pack	50	13.19	2.37
YESB500RTAB	5" Rosedome™ with Black Base for 1/8 Sheet cake - Combo Pack	50	13.00	2.37
<b>Fluted</b>				
YESB350FTAB	3.5" Fluted Dome with Black Base for 1/8 Sheetcake - Combo Pack	100	20.60	3.88
YESB500FTAB	5" Fluted Dome with Black Base for 1/8 Sheetcake - Combo Pack	50	12.30	2.37

### APET Sheet Cake Packaging - 1/4

Product Number	Description	Case Pack	Case Weight	Case Cube
<b>Rosedome™</b>				
YQSBSTAB	1/4 Black Sheet Cake	160	29.78	4.98
YQSB425LRLTAB	4.25" Rosedome™ with Black Base for 1/4 Sheet Cake - Combo Pack	50	21.15	4.22
YQSB500RSTAB	5" Rosedome™ with Black Base for 1/4 Sheet Cake - Combo Pack	75	31.51	5.77
YQSB600LRLTAB	6" Label Panel Rosedome™ with Black base for 1/4 Sheet Cake - Combo Pack	60	30.35	4.61
<b>Fluted</b>				
YQSBSTAB	1/4 Black Sheet Cake	160	29.78	4.98
YQSB425FSTAB				
YQSB500FSTAB	5" Fluted Dome with Black Base for 1/4 Sheet Cake - Combo Pack	75	31.92	5.40
YQSB600FSTAB	6" Fluted Dome with Black Base for 1/4 Sheet Cake - Combo Pack	60	25.70	4.62

### APET Sheet Cake Packaging - 1/2

Product Number	Description	Case Pack	Case Weight	Case Cube
<b>RoseDome™</b>				
YHSB500R1TAB	5" RoseDome™ with Black Base for 1/2 Sheet Cake - Combo Pack	25	21.77	4.14
<b>Fluted</b>				
YHSB1TAB	1/2 Black Sheet Cake Base	50	19.36	2.54
YHS500F1TAB	5" Fluted Dome for 1/2 Sheet Cake	50	22.56	4.10
YHSB500F1TAB	5" Fluted Dome with Black Base for 1/2 Sheet Cake - Combo Pack	25	30.60	4.78

### APET Bar Cake Packaging

Product Number	Description	Case Pack	Case Weight	Case Cube
<b>RoseDome™</b>				
YBCB425R	4.25" RoseDome™ with Black Base for Bar Cake - Combo Pack	100	13.52	4.16

### Clear Advantage™ SmartLock® Bakery/Deli Hingeware – APET

Product Number	Description	Capacity (fl. oz.)	Dimension (in inches)	Cube	Case Approx Wt.	Packing Sleeve	Case	Cases/ Unit Load
YCASH1050	APET Clear 5" Hinged Lid w/1-Cmpt. Tray	11 oz.	5 1/4 x 5 1/4 x 2 1/2	1.75	11.24	3/125	375	36
YCASH1160	APET Clear 6" Hinged Lid w/1-Cmpt. Tray	20 oz.	5 3/4 x 6 x 3	2.92	24.16	4/125	500	18
OCASH1120	APET Clear Medium Hinged Lid w/1-Cmpt. Tray	49 oz.	8 13/64 x 8 11/32 x 2 29/32	2.14	17.47	2/100	200	24
OCASH1123	APET Clear Medium Hinged Lid w/3-Cmpt. Tray	5 oz.(S) - 14 oz. (L)	8 13/64 x 8 11/32 x 2 29/32	2.14	19.48	1/200	200	24
OCASH1110	APET Clear Large Hinged Lid w/1-Cmpt. Tray	62 oz.	9 7/32 x 8 7/8 x 2 29/32	2.61	22.70	2/100	200	20
OCASH1124	APET Clear Medium Hinged Cookie Container	49 oz.	8 13/64 x 8 11/32 x 2 29/32	2.14	19.48	1/200	200	24
OCASH-1030	APET Clear Medium Hinged Container - Deep	39.6	8 5/8 x 7 3/4 x 3 1/4	2.66	24.70	2/125	250	18
OCASH3025	APET Clear Large Hinged Strudel Container	44 oz.	6 55/64 x 13 21/34 x 2 1/4	1.69	11.00	2/50	100	27
OCASH9446	APET Clear 12-Cup Cupcake/Muffin Hinged Container - 2 1/2" Cup Diameter	N/A	13 x 10 1/15 x 3 1/8	2.89	14.00	2/50	100	18
8SH3254CSD	8" Square 3.25" Tall Swirl Clear Hinged Muffin Container	--	8 5/8 x 8 5/8 x 3 1/4	3.00	13.00	--	120	--
OCASH0970	APET Clear Hinged 8" x 8" Bakery Container	170 oz.	8 3/4 x 8 1/4 x 3 5/8	2.78	21.02	2/100	200	18
OCASH9140	APET Clear Hinged 4 Count Muffin Container	N/A.	8 5/8 x 7 1/8 x 3	2.83	24.74	2/126	252	18

\*Part of the EarthChoice® line of RPET containers

**Hinged Lid Deli Containers – RPET**

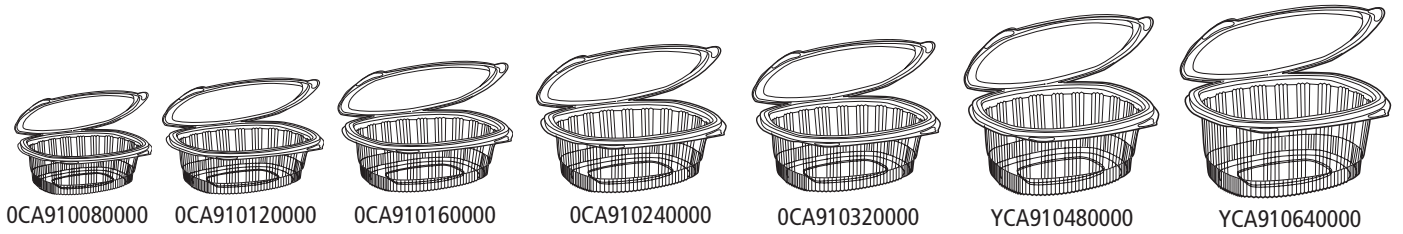

**Reynolds® Ultralite Bakeables® Ovenable & Microwaveable - CPET**

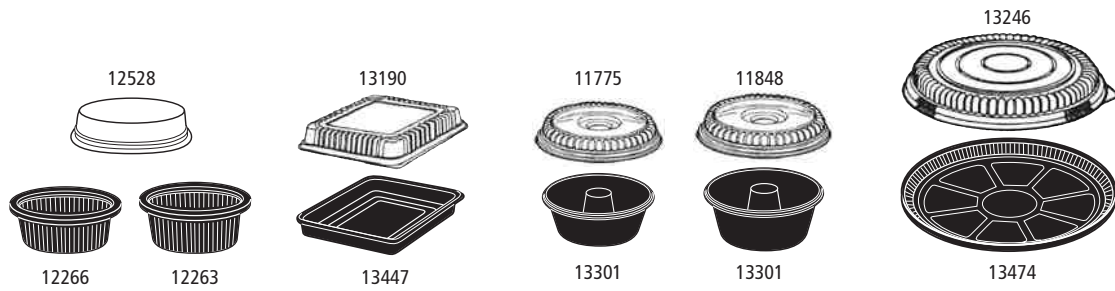

**Reynolds® Reservations® Ovenable Dual Ovenable Combo Packs- CPET/OPS**

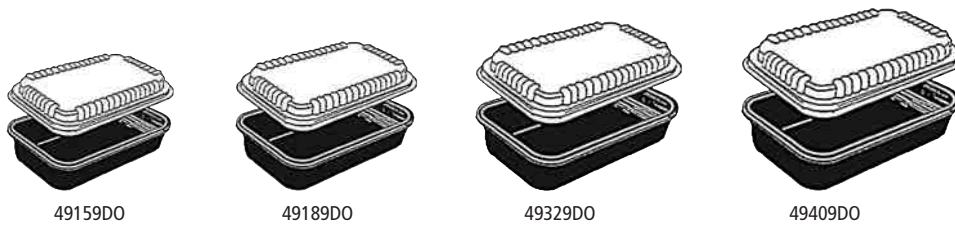

### Hinged Lid Deli Containers – RPET

Product Number	Description	Case Dimensions (in inches)	Cube	Case Approx. Wt.	Sleeve	Case Pack	Cases/ Unit Load
0CA910080000	8 oz. Clear Hinged Container	4.92 x 5.87 x 1.32	2.40	10.30	1/200	200	48
0CA910120000	12 oz. Clear Hinged Container	4.92 x 5.87 x 1.89	2.40	10.94	1/200	200	48
0CA910160000	16 oz. Clear Hinged Container	4.92 x 5.87 x 2.48	2.40	11.09	2/100	200	48
0CA910240000	24 oz. Clear Hinged Container	6.00 x 7.28 x 2.28	3.66	16.76	1/200	200	27
0CA910320000	32 oz. Clear Hinged Container	6.00 x 7.28 x 2.99	3.66	17.16	2/100	200	27
YCA910480000	48 oz. Clear Hinged Container	7.35 x 8.96 x 2.86	4.12	23.39	2/95	195	24
YCA910640000	64 oz. Clear Hinged Container	7.35 x 8.96 x 3.72	4.12	22.60	2/95	195	24

### Reynolds® Ultralite Bakeables® Ovenable & Microwaveable - CPET

Product Number	Description	Dimension (in inches)	Cube	Case Approx. Wt.	Case Pack	Cases/ Unit Load
12266	4" Round Black 4 oz. Cup - CPET	3 1/2 x 3 x 1 1/4	0.92	9.64	720	50
12263	4" Round Black 7 oz. Cup - CPET	3 1/2 x 3 x 1 1/2	0.92	9.64	720	60
12528	4" Clear Round Lid (After Bake Fit)	3 3/4 x 3 1/2 x 5/8	2.46	8.17	720	45
13325	4 Cell Large Muffin Base - CPET	--	1.05	19.12	240	105
13189APT	4 Cell Large Muffin Lid	--	3.67	14.20	240	30
13447	8" Square Black Base - CPET	6 1/2 x 6 1/2 x 1 3/4	1.05	15.58	240	105
13190	8" Clear Square Lid (After Bake Fit)	7 3/8 x 7 3/8 x 1 1/4	3.31	12.53	240	36
13301	8" 48 oz. Black Angel Food Pan - CPET	8 x 6 x 3	3.88	26.19	280	20
11775	8" Clear Angel Food Pan Lid (After Bake Fit)	8 x 7 1/2 x 1	3.31	12.53	240	20
13300	10" 82 oz. Black Angel Food Pan - CPET	9 x 4 x 4	4.01	29.88	200	30
11848	10" Clear Angel Food Pan Lid (After Bake Fit)	9 1/2 x 9 x 1	4.01	12.09	200	30
13474	12" Black Pizza/Cookie Pan Base - CPET	12 x 11 1/2 x 3/4	0.71	10.65	75	108
13246	12" Clear Pizza/Cookie Pan Lid (After Bake Fit)	12 x 11 1/2 x 2	2.38	8.03	75	36

### Reynolds® Reservations® Ovenable Dual Ovenable Combo Packs- CPET/OPS

Product Number	Description	Dimension (in inches)	Cube	Case Approx. Wt.	Case Pack	Cases/ Unit Load
49159DO	15 oz. Rectangular Black CPET Base Combo	Dome: 6 3/4 x 5 1/4 x 1 Base: 6 5/8 x 5 x 1 1/4	2.24	14.00	250 ea.	30
49189DO	18 oz. Rectangular Black CPET Base Combo	Dome: 6 3/4 x 5 1/4 x 1 Base: 6 5/8 x 5 x 1 1/2	1.55	15.03	250 ea.	30
49329DO	32 oz. Rectangular Black CPET Base Combo	Dome: 7 3/4 x 6 1/2 x 1 Base: 7 1/2 x 6 1/4 x 1 3/4	2.20	24.68	250 ea.	40
49409DO	40 oz. Rectangular Black CPET Base Combo	Dome: 7 3/4 x 6 1/2 x 1 Base: 7 1/2 x 6 1/4 x 1 3/4	3.51	25.22	250 ea.	24

## 4" & 5" Cake Packaging – APET – Bulk

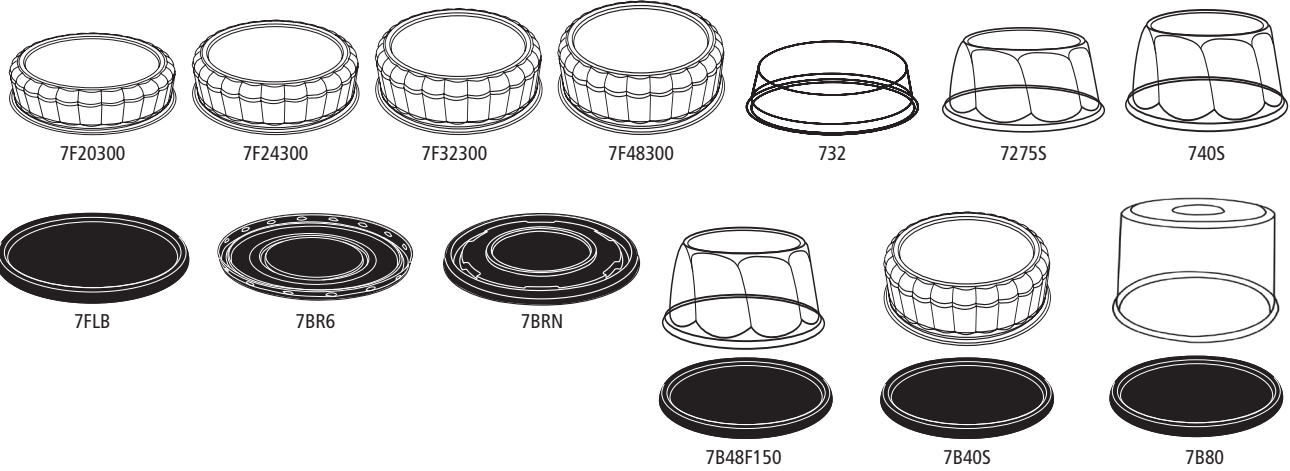

## 6" Cake Packaging – APET – Bulk

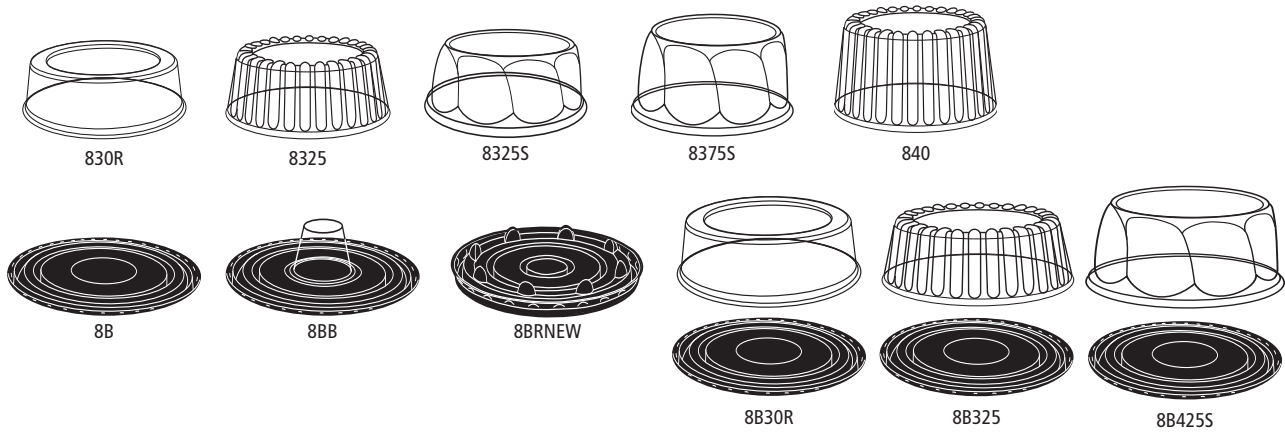

## 7" Cake Packaging – APET – Bulk

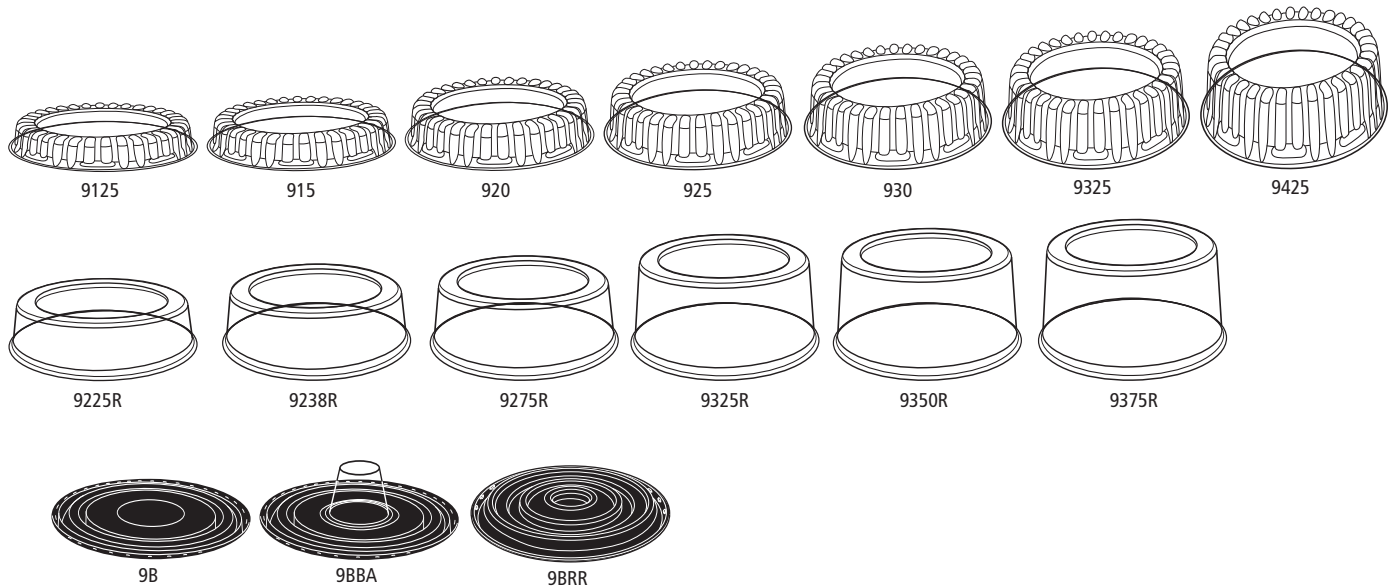

**4" & 5" Cake Packaging – APET – Bulk**

Product Number	Description	Dimensions (in inches)	Case Cube	Case Approx. Wt.	Case Pack
<b>Domes - Bulk</b>					
7F20300	1.5" Tall Fluted Dome for 4" & 5" Cake	6 5/8 x 1 1/2	3.80	11.00	300
732	2" Tall Smooth Wall Dome for 4" & 5" Cake	6 5/8 x 2	4.60	14.00	300
7F24300	2.25" Tall Fluted Dome for 4" & 5" Cake	6 5/8 x 2 1/4	3.80	12.00	300
7F32300	2.5" Tall Fluted Dome for 4" & 5" Cake	6 5/8 x 2 1/2	3.80	14.00	300
7275S	2.75" Tall Swirl Dome for 4" & 5" Cake	6 5/8 x 2 3/4	4.60	14.00	300
7F48300	3.25" Tall Fluted Dome for 4" & 5" Cake	6 5/8 x 3 1/4	3.80	17.00	300
740S	4" Tall Swirl Dome for 4" & 5" Cake	6 5/8 x 4	5.20	21.00	300
<b>Bases - Bulk</b>					
7FLB	Flat Black Base for 4" & 5" Cake	7	2.60	11.00	300
7BR6	Black Ring Base for 4" & 5" Cake - Holds 6" Cake Circle	7	2.60	11.00	300
7BRN	Black Ring Base w/Notches for 4" & 5" Cake - Holds 6" Cake Circle	7	2.60	10.00	300
<b>Dome &amp; Base Combos</b>					
7B48F150	3.25" Tall Fluted Dome w/Black Base for 4" & 5" Cake	6 5/8 x 3 1/4	4.60	14.00	150 Combo
7B40S	4" Tall Swirl Dome w/Black Base for 4" & 5" Cake	6 5/8 x 4	5.20	16.00	150 Combo
7B80	5.5" Tall Smooth Wall Dome w/Black Base for 4" & 5" Cake	6 5/8 x 5 1/2	5.20	23.00	150 Combo

**6" Cake Packaging – APET – Bulk**

Product Number	Description	Dimensions (in inches)	Case Cube	Case Approx. Wt.	Case Pack
<b>Domes - Bulk</b>					
830R	3" Tall Smooth Wall Dome for 6" Cake	7 3/4 x 3	3.20	16.00	200
8325	3.25" Tall Fluted Dome for 6" Cake	7 3/4 x 3 1/4	3.20	11.00	200
8325S	3.25" Tall Swirl Dome for 6" Cake	7 3/4 x 3 1/4	3.20	15.00	200
8375S	3.75" Tall Swirl Dome for 6" Cake	7 3/4 x 3 3/4	3.20	15.00	200
840	4" Tall Fluted Dome for 6" Cake	7 3/4 x 4	3.20	15.00	300
<b>Bases - Bulk</b>					
8B	Black Base for 6" Cake - Flat Bottom for Label	8	3.00	10.00	200
8BB	Black Base w/2" x 2.25" Cone w/Ring for 6" Bundt Cake	8 - 1 1/2" Tall Cone	3.50	10.00	200
8BRNEW	Black Ring Base for 6" Cake Circle	8	3.50	10.00	200
<b>Dome &amp; Base Combos</b>					
8B30R	3" Tall Smooth Wall Dome w/Black Base for 6" Cake	7 3/4 x 3	3.20	13.00	100 Combo
8B325	3.25" Tall Fluted Dome w/Black Base for 6" Cake	7 3/4 x 3 1/4	3.20	10.00	100 Combo
8B40	4" Tall Fluted Dome w/Black Base for 6" Cake	7 3/4 x 4	3.20	12.00	100 Combo
8B425S	4.25" Tall Swirl Dome w/Black Base for 6" Cake	7 3/4 x 4 1/4	3.20	15.00	100 Combo

**7" Cake Packaging – APET – Bulk**

Product Number	Description	Dimensions (in inches)	Case Cube	Case Approx. Wt.	Case Pack
<b>Domes - Bulk</b>					
9125	1.25" Tall Fluted Dome for 7" Cake	9 x 1 1/4	3.80	10.00	200
915DOME	1.5" Tall Fluted Dome for 7" Cake	9 x 1 1/2	3.80	11.00	200
920DOME	2" Tall Fluted Dome for 7" Cake	9 x 1 1/2	3.80	11.00	200
9225R	2 1/8" Tall Smooth Wall Dome for 7" Cake	9 x 2 1/8	3.80	16.00	200
9238R	2 3/8" Tall Smooth Wall Dome for 7" Cake	9 x 2 3/8	3.80	18.00	200
925	2.5" Tall Fluted Dome for 7" Cake	9 x 2 1/2	3.80	12.00	200
9275R	2.75" Tall Smooth Wall Dome for 7" Cake	9 x 2 3/4	3.80	18.00	200
930	3" Tall Fluted Dome for 7" Cake	9 x 3	3.80	16.00	200
9325	3.25" Tall Fluted Dome for 7" Cake	9 x 3 1/4	5.00	16.00	200
9325R	3.25" Tall Smooth Wall Dome for 7" Cake	9 x 3 1/4	3.80	25.00	200
9350R	3.5" Tall Smooth Wall Dome for 7" Cake	9 x 3 1/2	5.00	23.00	200
9375R	3.75" Tall Smooth Wall Dome for 7" Cake	9 x 3 3/4	5.00	23.00	200
9425	4.25" Tall Fluted Dome for 7" Cake	9 x 4 1/4	5.00	18.00	200
<b>Bases - Bulk</b>					
9B	Black Base for 7" Cake - Holds a 8.125 Cake Circle	9 1/16	3.00	12.00	200
9BBA	Black Base w/2" x 2.9" Cone for 7" Bundt Cake	9 1/16 - 2" Tall Cone	3.50	12.00	200
9BB	Black Base w/2" x 3" Cone for 7" Bundt Cake	9 1/16 - 2" Tall Cone	3.50	12.00	200
9BRR	Black 7.25" Diameter Extra Ring Base for 7" Cake	9 1/16	3.00	12.00	200

## 7" Cake Swirl Packaging – APET – Bulk

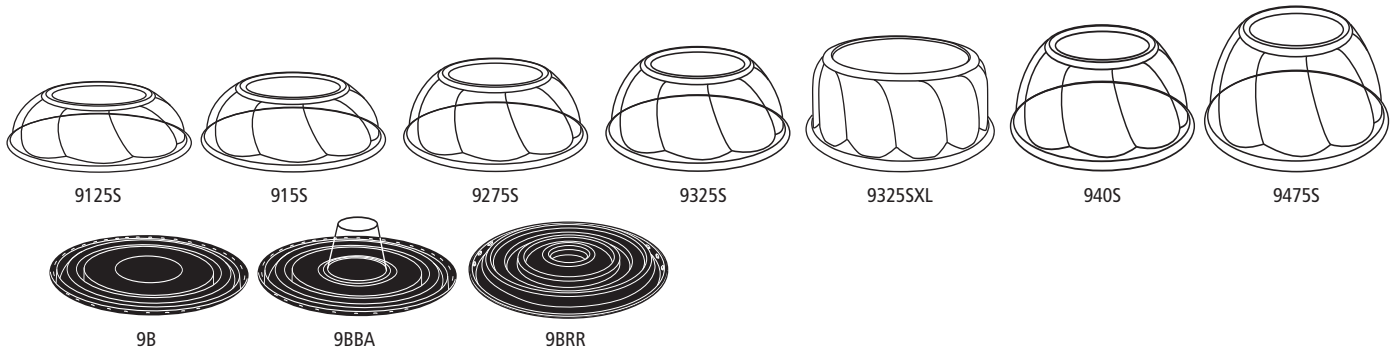

## 7" Cake Packaging – APET – Combos

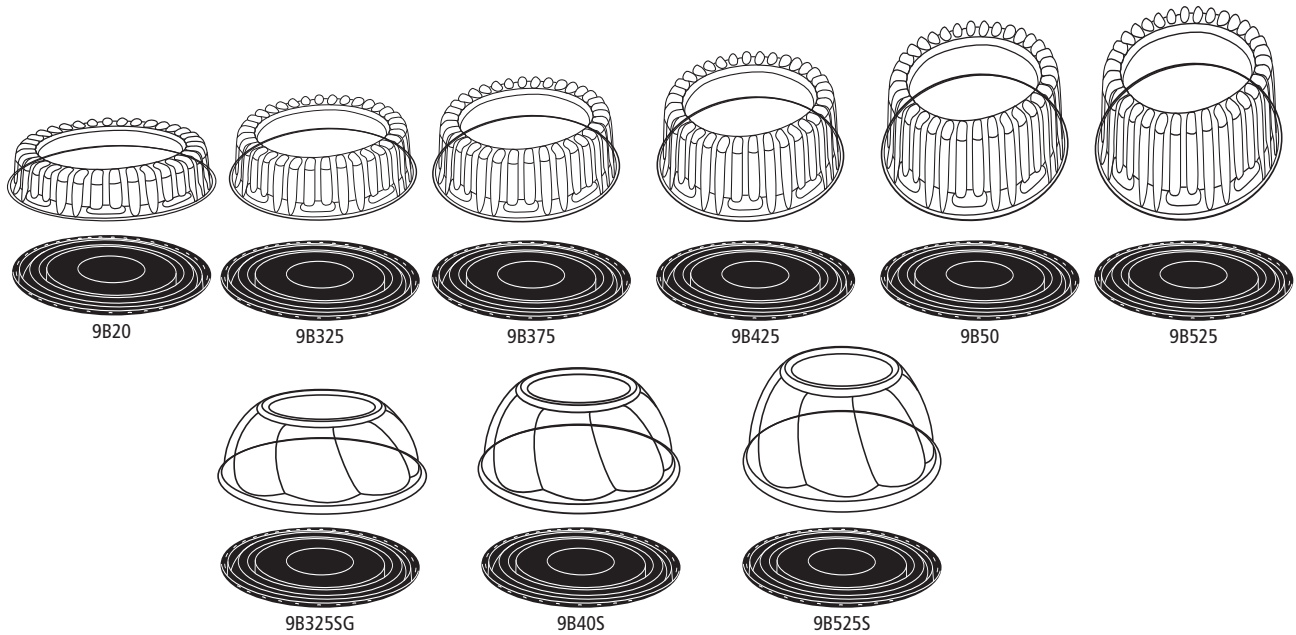

## 8" Cake Fluted Packaging – APET – Bulk

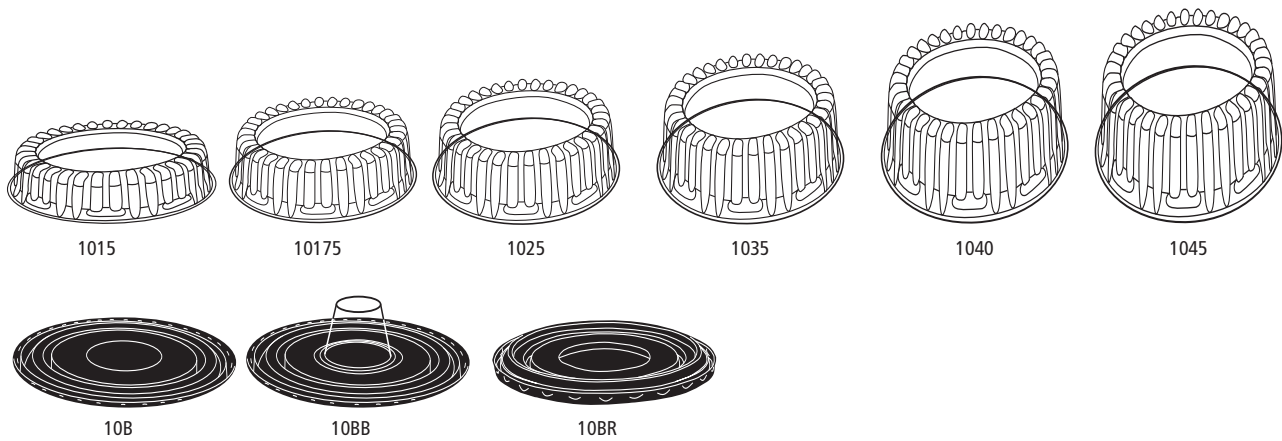

### 7" Cake Packaging – APET – Bulk

Product Number	Description	Dimensions (in inches)	Case Cube	Case Approx. Wt.	Case Pack
<b>Domes - Bulk</b>					
9125S	1.25" Tall Swirl Dome for 7" Cake	9 x 1 1/4	3.00	11.00	200
915S	1.5" Tall Fluted Dome for 7" Cake	9 x 1 1/2	3.00	12.00	200
9275S	2.75" Tall Swirl Dome for 7" Cake	9 x 2 3/4	3.80	14.00	200
9325S	3.25" Tall Swirl Dome for 7" Cake	9 x 3 1/4	3.80	18.00	200
9325SXL	3.25" Tall Swirl Dome for 7" Decorated Cake	9 x 3 1/4	3.80	16.00	200
940S	4" Tall Swirl Dome for 7" Cake	9 x 3 1/4	3.80	18.00	200
9475S	4.75" Tall Swirl Dome for 7" Cake	9 x 4 1/4	5.00	23.00	200
<b>Bases - Bulk</b>					
9B	Black Base for 7" Cake - Holds a 8.125 Cake Circle	9 1/16	3.00	12.00	200
9BBA	Black Base w/2" x 2.9" Cone for 7" Bundt Cake	9 1/16 - 2" Tall Cone	3.50	12.00	200
9BB	Black Base w/2" x 3" Cone for 7" Bundt Cake	9 1/16 - 2" Tall Cone	3.50	12.00	200
9BRR	Black 7.25" Diameter Extra Ring Base for 7" Cake	9 1/16	3.00	12.00	200

### 7" Cake Packaging – APET – Combos

Product Number	Description	Dimensions (in inches)	Case Cube	Case Approx. Wt.	Case Pack
9B20	2" Tall Fluted Dome w/Black Base for 7" Cake	9 x 2	3.80	12.00	100 Combo
9B325	3.25" Tall Fluted Dome w/Black Base for 7" Cake	9 x 3 1/4	3.80	14.00	100 Combo
9B375	3.75" Tall Fluted Dome w/Black Base for 7" Cake	9 x 3 3/4	5.00	14.00	100 Combo
9B325SG	3.25" Tall Swirl Dome w/Black Base for 7" Cake	9 x 3 1/4	4.03	16.50	100 Combo
9B40S	4" Tall Swirl Dome w/Black Base for 7" Cake	9 x 4	3.80	15.00	100 Combo
9B425	4.25" Tall Fluted Dome w/Black Base for 7" Cake	9 x 4 1/4	5.00	15.00	100 Combo
9B50	5" Tall Fluted Dome w/Black Base for 7" Cake	9 x 5	5.00	17.00	100 Combo
9B525	5.25" Tall Fluted Dome w/Black Base for 7" Cake	9 x 5 1/4	5.00	17.00	100 Combo
9B525S	5.25" Tall Swirl Dome w/Black Base for 7" Cake	9 x 5 1/4	5.00	19.00	100 Combo

### 8" Cake Fluted Packaging – APET – Bulk

Product Number	Description	Dimensions (in inches)	Case Cube	Case Approx. Wt.	Case Pack
<b>Domes - Bulk</b>					
1015	1.5" Tall Fluted Dome for 8" Cake	9 3/4 x 1 1/2	3.40	13.00	200
10175	1.75" Tall Fluted Dome for 8" Cake	9 3/4 x 1 3/4	4.50	15.00	200
1025	2.5" Tall Fluted Dome for 8" Cake	9 3/4 x 2 1/2	4.50	16.00	200
1035	3.5" Tall Fluted Dome for 8" Cake	9 3/4 x 3 1/2	5.60	18.00	200
10375SPK	3.75" Tall Fluted Dome w/Spike for 8" Cake	9 3/4 x 3 3/4	5.60	22.00	200
1040	4" Tall Fluted Dome for 8" Cake	9 3/4 x 4	5.60	22.00	200
1045	4.5" Tall Fluted Dome for 8" Cake	9 3/4 x 4 1/2	5.60	22.00	200
1050	5" Tall Fluted Dome for 8" Cake	9 3/4 x 5	5.60	26.00	200
10525	5.25" Tall Fluted Dome for 8" Cake	9 3/4 x 5 1/4	5.60	26.00	200
<b>Bases - Bulk</b>					
10B	Black Base for 8" Cake	9 7/8	3.90	14.00	200
10BB	Black Base w/2.75 x 3.25 Cone for 8" Bundt Cake	9 7/8 - 2" Tall Cone	4.50	16.00	200
10BB2.25X3	Black Base w/2.25 x 3 Cone for 8" Bundt Cake	9 7/8 - 2" Tall Cone	4.50	16.00	200
10BB2.6X3	Black Base w/2.6 x 3 Cone for 8" Bundt Cake	9 7/8 - 2" Tall Cone	4.50	16.00	200
10BBF1.4X3	Black Base w/1.4 x 3 Cone for 8" Bundt Cake	9 7/8 - 2" Tall Cone	4.50	16.00	200
10BR	Black Small Ring Base for 8" Cake - Holds a 8.125" Cake Circle	9 7/8	3.90	14.00	200

## 8" Cake Swirl Packaging – APET – Bulk

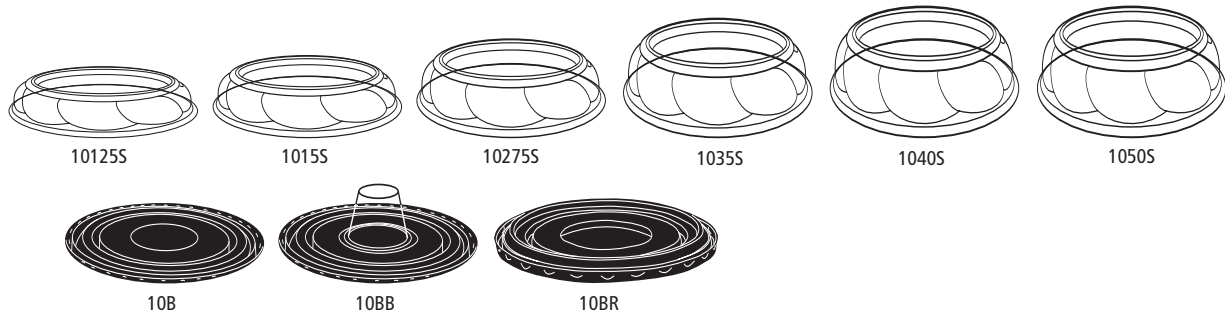

## 8" Cake Smooth Wall Packaging – APET – Bulk

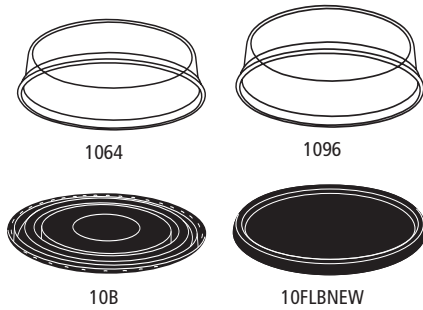

## 8" Cake Packaging – APET – Combo

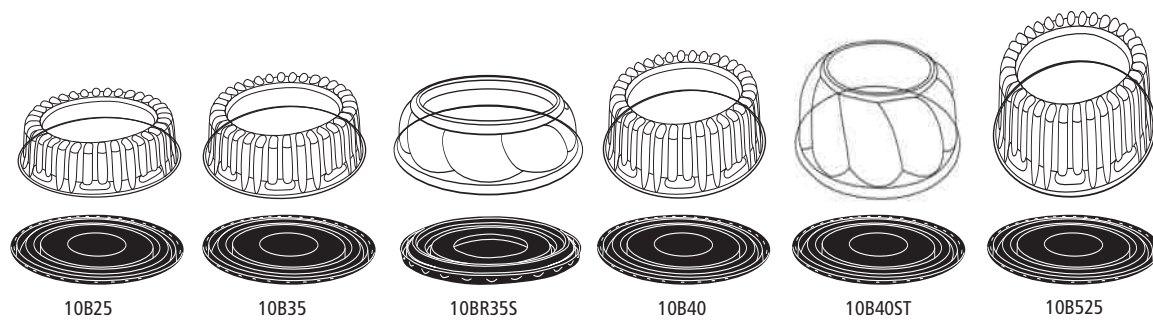

## 8" Decorated Cake Packaging – APET – Combo

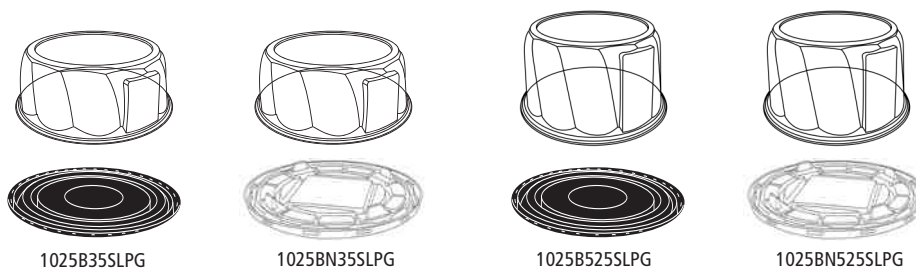



### 8" Cake Swirl Packaging – APET – Bulk

Product Number	Description	Dimensions (in inches)	Case Cube	Case Approx. Wt.	Case Pack
<b>Domes - Bulk</b>					
10125S	1.25" Tall Swirl Dome for 8" Cake	9 3/4 x 1 1/4	4.50	15.00	200
1015S	1.5" Tall Swirl Dome for 8" Cake	9 3/4 x 1 1/2	4.50	15.00	200
1025S	2.5" Tall Swirl Dome for 8" Cake	9 3/4 x 2 1/2	4.50	16.00	200
10275S	2.75" Tall Swirl Dome for 8" Cake	9 3/4 x 2 3/4	4.50	16.00	200
1035S	3.5" Tall Swirl Dome for 8" Cake	9 3/4 x 3 1/2	5.60	24.00	200
1040ST	4" Tall Tapered Swirl Dome for 8" Cake	9 3/4 x 4	5.60	22.00	200
1050S	5" Tall Swirl Dome for 8" Cake	9 3/4 x 5	4.90	24.00	200
10525S100	5.25" Tall Swirl Dome for 8" Cake	9 3/4 x 5 1/4	3.40	16.00	200
<b>Bases - Bulk</b>					
10B	Black Base for 8" Cake	9 7/8	3.90	14.00	200
10BB	Black Base w/2.75 x 3.25 Cone for 8" Bundt Cake	9 7/8 - 2" Tall Cone	4.50	16.00	200
10BB2.25X3	Black Base w/2.25 x 3 Cone for 8" Bundt Cake	9 7/8 - 2" Tall Cone	4.50	16.00	200
10BB2.6X3	Black Base w/2.6 x 3 Cone for 8" Bundt Cake	9 7/8 - 2" Tall Cone	4.50	16.00	200
10BR	Black Small Ring Base for 8" Cake - Holds a 8.125" Cake Circle	9 7/8	3.90	14.00	200

### 8" Cake Smooth Wall Packaging – APET – Bulk

Product Number	Description	Dimensions (in inches)	Case Cube	Case Approx. Wt.	Case Pack
<b>Domes - Bulk</b>					
1064	2" Tall Smooth Wall Dome for 8" Cake	9 3/4 x 2	3.40	11.00	100
1096	2 7/8" Tall Smooth Wall Dome for 8" Cake	9 3/4 x 2 7/8	3.40	14.00	100
<b>Bases - Bulk</b>					
10B	Black Base for 8" Cake	9 7/8	3.90	16.00	200
10FLBNEW	Flat Black Base for 8" Cake	9 7/8	3.40	16.00	200

### 8" Cake Packaging – APET – Combo

Product Number	Description	Dimensions (in inches)	Case Cube	Case Approx. Wt.	Case Pack
10B25	2.5" Tall Fluted Dome w/Black Base for 8" Cake	9 3/4 x 2 1/2	4.50	15.00	100 Combo
10B35	3 1/2" Tall Fluted Dome w/Black Base for 8" Cake	9 3/4 x 3 1/2	4.50	16.00	100 Combo
10BR35	3 1/2" Tall Fluted Dome w/Black Ring Base for 8" Cake	9 3/4 x 3 1/2	4.50	16.00	100 Combo
10BR35S	3 1/2" Tall Swirl Dome w/Black Ring Base for 8" Cake	9 3/4 x 3 1/2	4.50	19.00	100 Combo
10B40	4" Tall Fluted Dome w/Black Base for 8" Cake	9 3/4 x 4	4.50	18.00	100 Combo
10B40ST	4" Tall Swirl Tapered Dome w/Black Base for 8" Cake	9 3/4 x 4	4.50	18.00	100 Combo
10B45	4 1/2" Tall Fluted Dome w/Black Base for 8" Cake	9 3/4 x 4 1/2	4.50	18.00	100 Combo
10B50	5" Tall Fluted Dome w/Black Base for 8" Cake	9 3/4 x 5	4.50	20.00	100 Combo
10B50S	5" Tall Swirl Dome w/Black Base for 8" Cake	9 3/4 x 5	5.10	23.00	100 Combo
10B525	5.25" Tall Fluted Dome w/Black Base for 8" Cake	9 3/4 x 5 1/4	4.50	20.00	100 Combo

### 8" Decorated Cake Packaging – APET – Combo

Product Number	Description	Dimensions (in inches)	Case Cube	Case Approx. Wt.	Case Pack
1025B35SLPG	3.5" Tall Swirl Dome w/Wrinkle Free Label Panel w/Black Base for 8" Decorated Cake (Grocery Application)	10 x 3 1/2	5.90	20.00	100 Combo
1025BN35SLPG	3.5" Tall Swirl Dome w/Wrinkle Free Label Panel w/Black Nub Ring Base for 8" Decorated Cake (Grocery Application)	10 x 3 1/2 (Holds a 8.05" Cake Circle)	5.90	20.00	100 Combo
1025B525SLPG	5.25" Tall Swirl Dome w/Wrinkle Free Label Panel w/Black Base for 8" Decorated Cake (Grocery Application)	10 x 5 1/4	5.90	23.00	100 Combo
1025BN525SLPG	5.25" Tall Swirl Dome w/Wrinkle Free Label Panel w/Black Nub Ring Base for 8" Decorated Cake (Grocery Application)	10 x 3 1/2 (Holds a 8.05" Cake Circle)	5.90	23.00	100 Combo

**9" Cake Packaging – APET – Bulk**

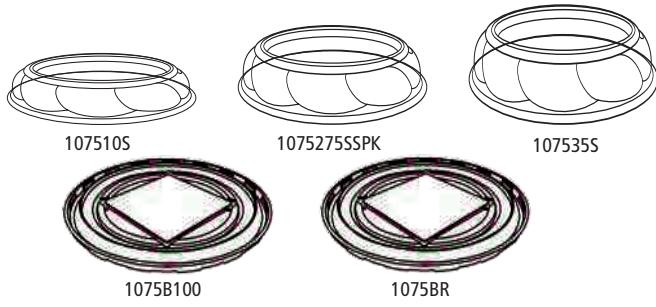

**9" Cake Packaging – APET – Combo**

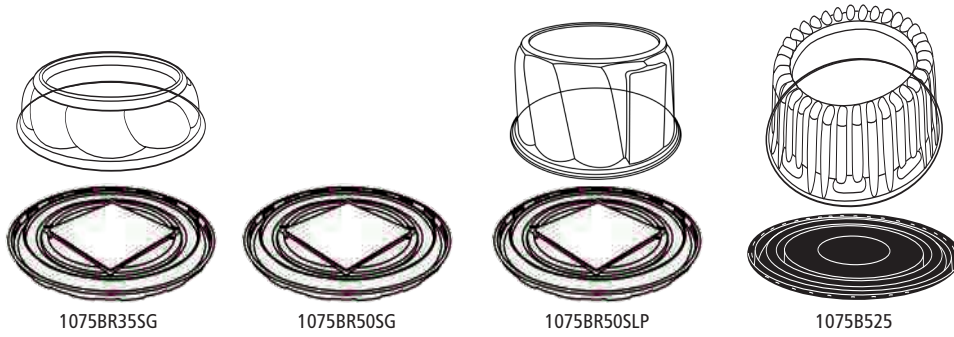

**9" Cake Packaging – APET – Bulk**

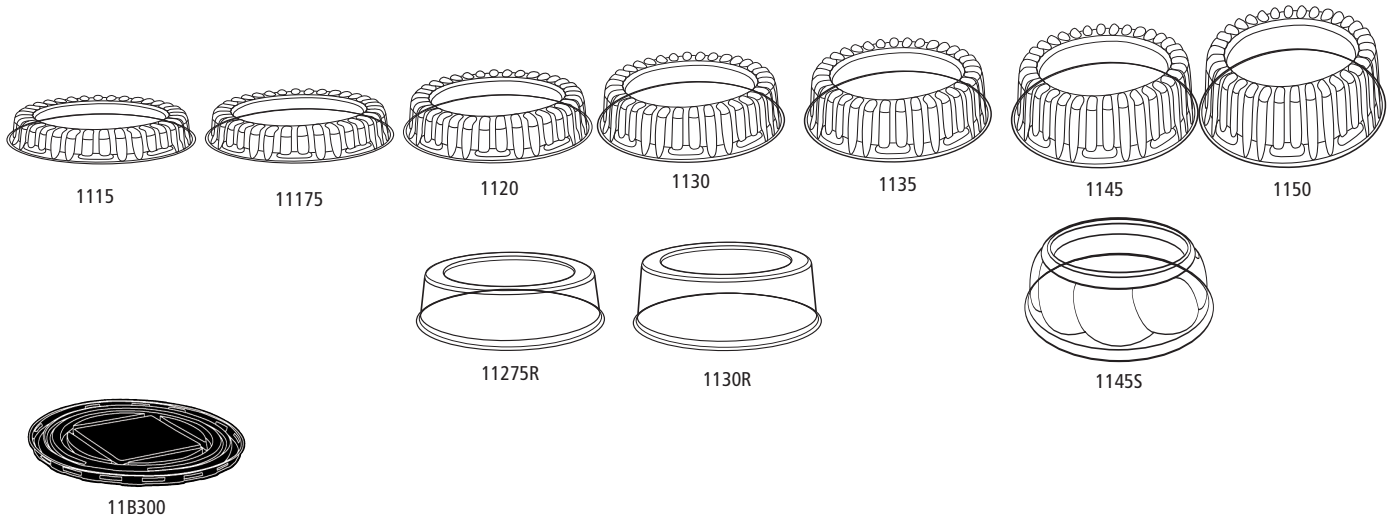

**9" Cake Packaging – APET – Combo**

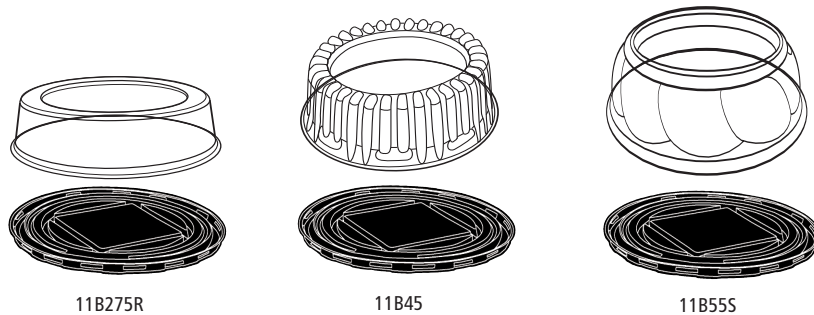

### 9" Cake Packaging – APET – Bulk

Product Number	Description	Dimensions (in inches)	Case Cube	Case Approx. Wt.	Case Pack
<b>Domes - Bulk</b>					
107510S	1" Tall Swirl Dome for 9" Cake	10 3/4 x 1	4.20	18.00	200
1075275SSPK	2.75" Tall Swirl Dome for 9" Cake	10 3/4 x 2 3/4	4.20	10.00	200
107535S	3.5" Tall Swirl Dome for 9" Cake	10 3/4 x 3 1/2	4.20	16.00	200
<b>Bases - Bulk</b>					
1075B100	Black Base for 9" Cake	11 1/8	3.00	9.00	200
1075BR	Black Ring Base for 9" Cake - Holds a 9" Cake Circle	11 1/8	3.00	9.00	200

### 9" Cake Packaging – APET – Combo

Product Number	Description	Dimensions (in inches)	Case Cube	Case Approx. Wt.	Case Pack
1075BR35SG	3.5" Tall Swirl Dome w/Black Ring Base for 9" Cake	10 3/4 x 3 1/2	3.00	13.00	50 Combo
1075BR50SG	5" Tall Swirl Dome w/Black Ring Base for 9" Cake	10 3/4 x 5	4.20	15.50	50 Combo
1075BR50SLP	5" Tall Swirl Dome w/Label Panel w/Black Ring Base for 9" Cake	10 3/4 x 5	4.20	14.00	50 Combo
1075B525	5.25" Tall Fluted Dome w/Black Base for 9" Cake	10 3/4 x 5 1/4	4.20	12.00	50 Combo

### 9" Cake Packaging – APET – Bulk

Product Number	Description	Dimensions (in inches)	Case Cube	Case Approx. Wt.	Case Pack
<b>Domes - Bulk</b>					
1115	1.5" Tall Fluted Dome for 9" Cake	11 1/4 x 1 1/2	3.00	9.00	100
11175	1.75" Tall Fluted Dome for 9" Cake	11 1/4 x 1 3/4	3.00	10.00	100
1120	2" Tall Fluted Dome for 9" Cake	11 1/4 x 2	4.20	10.00	100
11275R	2.75" Tall Smooth Wall Dome for 9" Cake	11 1/4 x 2 3/4	4.20	15.00	100
1130	3" Tall Fluted Dome for 9" Cake	11 1/4 x 3	4.20	11.00	100
1130R	3" Tall Smooth Wall Dome for 9" Cake	11 1/4 x 3	4.20	17.00	100
1135	3.5" Tall Fluted Dome for 9" Cake	11 1/4 x 3 1/2	4.20	14.00	100
1145	4.5" Tall Fluted Dome for 9" Cake	11 1/4 x 4 1/2	4.20	17.00	100
1145S	4.5" Tall Swirl Dome for 9" Cake	11 1/4 x 4 1/2	4.20	20.00	100
11488	4 7/8" Tall Fluted Dome for 9" Cake	11 1/4 x 4 7/8	4.20	17.00	100
1150	5" Tall Fluted Dome for 9" Cake	11 1/4 x 5	4.20	17.00	100
<b>Bases - Bulk</b>					
11B300	Black Base for 9" Cake	11 5/8	7.10	30.00	300
11BR300	Black Ring Base for 9" Cake - Holds a 10" Cake Circle	11 5/8	7.10	30.00	300

### 9" Cake Packaging – APET – Combo

Product Number	Description	Dimensions (in inches)	Case Cube	Case Approx. Wt.	Case Pack
11B275R	2.75" Tall Smooth Wall Dome w/Black Base for 9" Cake	11 1/4 x	3.00	13.00	50 Combo
11B35	3.5" Tall Fluted Dome w/Black Base for 9" Cake	11 1/4 x 3 1/2	3.00	12.00	50 Combo
11B45	4.5" Tall Fluted Dome w/Black Base for 9" Cake	11 1/4 x 4 1/2	3.00	13.00	50 Combo
11B50	5" Tall Fluted Dome w/Black Base for 9" Cake	11 1/4 x 5	3.00	13.00	50 Combo
11B55S	5.5" Tall Swirl Dome w/Black Base for 9" Cake	11 1/4 x 5 1/2	3.00	14.00	50 Combo

**10" Cake Packaging – APET – Bulk**

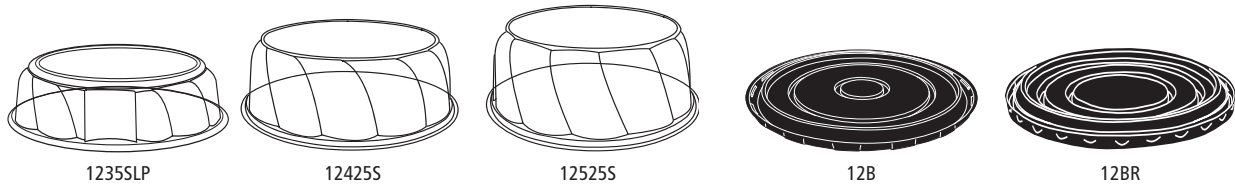

**11" Cake Packaging – APET – Bulk**

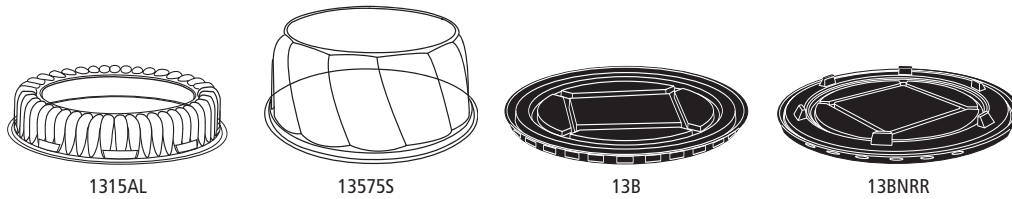

**11" Cake Packaging – APET – Combo**

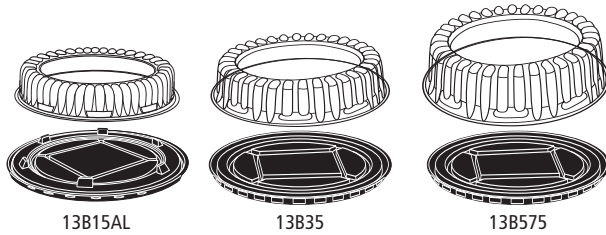

**1/4 Sheet Cake Packaging – APET – Bulk**

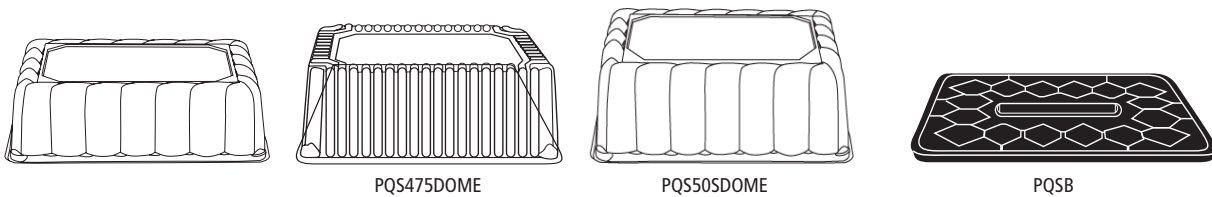

**1/4 Sheet Cake Packaging – APET – Combos**

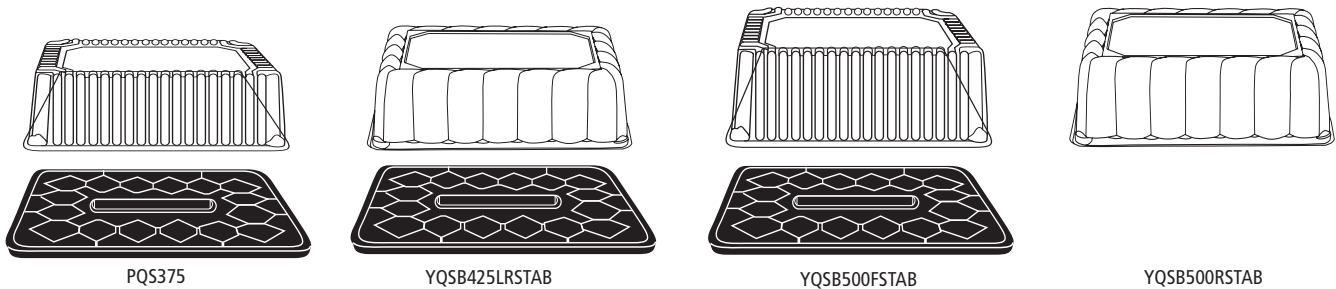

**1/2 Sheet Cake Packaging – APET – Combo**

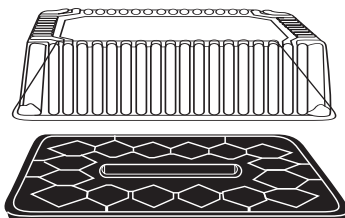

### 10" Cake Packaging – APET – Bulk

Product Number	Description	Dimensions (in inches)	Case Cube	Case Approx. Wt.	Case Pack
<b>Domes - Bulk</b>					
12355LP	3.5" Tall Swirl Dome w/Wrinkle Free Label Panel for 10" Cake	11 7/8 x 3 1/2	4.20	17.00	100
12425S	4.25" Tall Swirl Dome for 10" Cake	11 7/8 x 4 1/4	4.20	21.00	100
12525S	5.25" Tall Swirl Dome for 10" Cake	11 7/8 x 5 1/4	4.20	24.00	100
<b>Bases - Bulk</b>					
12B	Black Base for 10" Cake	12 1/4	3.60	11.00	100
12BR	Black Ring Base for 10" Cake - Holds a 10.125" Cake Circle	12 1/4	3.60	11.00	100

### 11" Cake Packaging – APET – Bulk

Product Number	Description	Dimensions (in inches)	Case Cube	Case Approx. Wt.	Case Pack
<b>Domes - Bulk</b>					
1315AL	1.5" Tall Fluted Dome w/Recessed Top for 11" Cake	12 4/7 x 1 1/2	3.60	11.00	100
13575S	5.75" Tall Swirl Dome for 11" Cake	12 4/7 x 5 3/4	3.60	18.00	100
<b>Bases - Bulk</b>					
13B	Black Base for 11" Cake	13	3.60	12.00	100
13BNRR	Black Recessed Nub Ring Base for 11" Cake	13	3.60	12.00	300

### 11" Cake Packaging – APET – Combo

Product Number	Description	Dimensions (in inches)	Case Cube	Case Approx. Wt.	Case Pack
13B15AL	1.5" Tall Fluted Dome w/Recessed Top w/Black Base for 11" Cake	12 4/7 x 1 1/2	3.60	12.00	50 Combo
13B35	3.5" Tall Fluted Dome w/Black Base for 11" Cake	12 4/7 x 3 1/2	4.20	14.00	50 Combo
13B575	5.25" Tall Fluted Dome w/Black Base for 11" Cake	12 4/7 x 5 1/4	4.20	17.00	50 Combo

### 1/4 Sheet Cake Packaging – APET – Bulk

Product Number	Description	Dimensions (in inches)	Case Cube	Case Approx. Wt.	Case Pack
<b>1/4 Sheet Domes - Bulk</b>					
PQS425SDOME	4.25" Tall Swirl 1/4 Sheet Dome	14 1/2 x 10 3/4 x 4 1/4	2.30	13.00	50
PQS475DOME	4.75" Tall Fluted 1/4 Sheet Dome	14 1/2 x 10 3/4 x 4 3/4	2.30	11.00	50
PQS50SDOME	5" Tall Swirl 1/4 Sheet Dome	14 1/2 x 10 3/4 x 5	2.30	13.00	50
<b>1/4 Sheet Base - Bulk</b>					
PQSB	1/4 Sheet Cake Black Base	15 x 11 1/4	1.40	8.00	50

### 1/4 Sheet Cake Packaging – APET – Combos

Product Number	Description	Dimensions (in inches)	Case Cube	Case Approx. Wt.	Case Pack
PQS375	3.75" Tall Fluted 1/4 Sheet Dome w/Black Base	14 1/2 x 10 3/4 x 3 3/4	3.80	17.00	50 Combo
PQS425	4.25" Tall Fluted 1/4 Sheet Dome w/Black Base	14 1/2 x 10 3/4 x 4 1/4	3.80	18.00	50 Combo
YQSB425LRSTAB	4.25" Tall Swirl 1/4 Sheet Dome w/Black Base	14 1/2 x 10 3/4 x 4 1/4	3.80	21.00	50 Combo
YQSB500FSTAB	5" Tall Fluted 1/4 Sheet Dome w/Black Base	14 1/2 x 10 3/4 x 5	3.80	20.00	50 Combo
YQSB500RSTAB	5" Tall Swirl 1/4 Sheet Dome w/Black Base	14 1/2 x 10 3/4 x 5	3.80	21.00	50 Combo
PQS50SLP	5" Tall Swirl 1/4 Sheet Dome w/Label Panel w/Black Base	14 1/2 x 10 3/4 x 5	3.80	21.00	50 Combo
YQSB600FSTAB	6" Tall Fluted 1/4 Sheet Dome w/Black Base	14 1/2 x 10 3/4 x 6			50 Combo

### 1/2 Sheet Cake Packaging – APET – Combo

Product Number	Description	Dimensions (in inches)	Case Cube	Case Approx. Wt.	Case Pack
PHS40	4" Tall Fluted 1/2 Sheet Cake Dome w/Black Base	20 x 15 x 4	3.80	19.00	25 Combo

**Buy-Me-Now™ Dessert Wedge – APET**



10803

**5" & 6" Pie Packaging – APET – Bulk**



7F20300

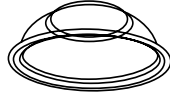

718P600

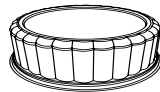

7F24300



7F32300

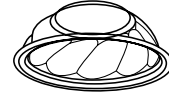

724PS600

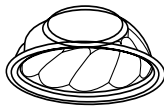

7275S

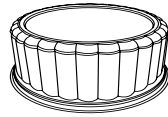

7F48300

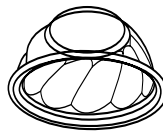

732PS600

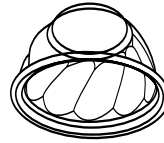

740S



7PS

**8" Pie Packaging – APET – Bulk**



9125



9125S



915DOME

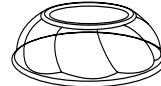

915S

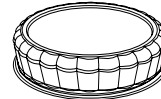

920DOME



920SDOME

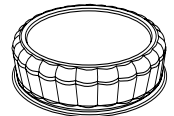

925DOME



9275S

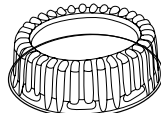

9325



9325S

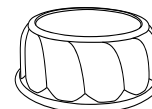

9325SXL

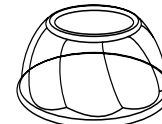

940S



9PW



9P

**8" Pie Packaging – APET – Combo**



9P125



9P15

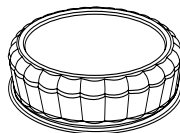

9P25

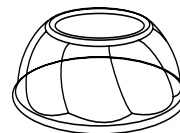

9P30S

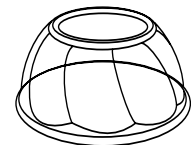

9P40S



### 5" & 6" Pie Packaging – APET – Bulk

Product Number	Description	Dimensions (in inches)	Case Cube	Case Approx. Wt.	Case Pack
10803	Clear Cake/Pie Single Slice Hinged Wedge Container	5 3/4 x 5 7/8 x 3	2.58	9.20	250

### 5" & 6" Pie Packaging – APET – Bulk

Product Number	Description	Dimensions (in inches)	Case Cube	Case Approx. Wt.	Case Pack
<b>Domes - Bulk</b>					
7F20300	1.5" Tall Fluted Dome for 5" & 6" Pie	6 5/6 x 1 1/2	3.80	11.00	300
718P600	2" Tall Smooth Wall Dome for 5" & 6" Pie	6 5/6 x 1 1/2	5.20	21.00	600
7F24300	2.25" Tall Fluted Dome for 5" & 6" Pie	6 5/6 x 2 1/4	3.80	12.00	300
7F32300	2.5" Tall Fluted Dome for 5" & 6" Pie	6 5/6 x 2 1/2	3.80	14.00	300
724PS600	2 5/8" Tall Swirl Dome for 5" & 6" Pie	6 5/6 x 2 5/8	5.20	22.00	600
72755	2.75" Tall Swirl Dome for 5" & 6" Pie	6 5/6 x 2 3/4	4.60	14.00	300
7F48300	3.25" Tall Fluted Dome for 5" & 6" Pie	6 5/6 x 3 1/4	3.80	17.00	300
732PS600	3 1/8" Tall Swirl Dome for 5" & 6" Pie	6 5/6 x 3 1/8	5.20	29.00	600
740S	4" Tall Swirl Dome for 5" & 6" Pie	6 5/6 x 4	5.20	21.00	300
<b>Bases - Bulk</b>					
7P6	Black Base for 5" & 6" Pie	7	4.60	21.00	100

### 8" Pie Packaging – APET – Bulk

Product Number	Description	Dimensions (in inches)	Case Cube	Case Approx. Wt.	Case Pack
<b>Domes - Bulk</b>					
9125	1.25" Tall Fluted Dome for 8" Pie	9 x 1 1/4	3.80	10.00	200
9125S	1.25" Tall Swirl Dome for 8" Pie	9 x 1 1/4	3.00	11.00	200
915DOME	1.5" Tall Fluted Dome for 8" Pie	9 x 1 1/2	3.00	12.00	200
915S	1.5" Tall Swirl Dome for 8" Pie	9 x 1 1/2	3.00	12.00	200
920DOME	2" Tall Fluted Dome for 8" Pie	9 x 2	3.80	11.00	200
920SDOME	2" Tall Swirl Dome for 8" Pie	9 x 2	3.50	12.00	200
925DOME	2.5" Tall Fluted Dome for 8" Pie	9 x 2 1/2	3.80	12.00	200
9275S	2.75" Tall Swirl Dome w/Crust Saver Feature for 8" Pie	9 x 2 3/4	3.80	14.00	200
9325	3.25" Tall Fluted Dome for 8" Pie	9 x 3 1/4	5.00	16.00	200
9325S	3.25" Tall Swirl Dome for 8" Pie	9 x 3 1/4	3.80	18.00	200
9325SXL	3.25" Tall Swirl Dome for 8" Decorated Pie	9 x 3 1/4	3.80	16.00	200
940S	4" Tall Swirl Dome for 8" Pie	9 x 4	3.80	18.00	200
<b>Bases - Bulk</b>					
9PW	Black Base for 1" Deep for 8" Pie	9 1/16	3.00	14.00	200
9P	Black Base for 1 1/8" Deep for 8" Pie	9 1/16	3.00	14.00	200

### 8" Pie Packaging – APET – Combo

Product Number	Description	Dimensions (in inches)	Case Cube	Case Approx. Wt.	Case Pack
9P125	1.25" Tall Fluted Dome w/Black Pie Base for 8" Pie	9 x 1 1/4	3.80	12.00	100 Combo
9P15	1.5" Tall Fluted Dome w/Black Pie Base for 8" Pie	9 x 1 1/2	3.80	13.00	100 Combo
9P25	2.5" Tall Fluted Dome w/Black Pie Base for 8" Pie	9 x 2 1/2	3.80	13.00	100 Combo
9P30S	3" Tall Swirl Dome w/Black Pie Base for 8" Pie	9 x 3	3.80	15.00	100 Combo
9P40S	4" Tall Swirl Dome w/Black Pie Base for 8" Pie	9 x 4	3.80	16.00	100 Combo

**9" Pie Packaging – APET – Bulk**

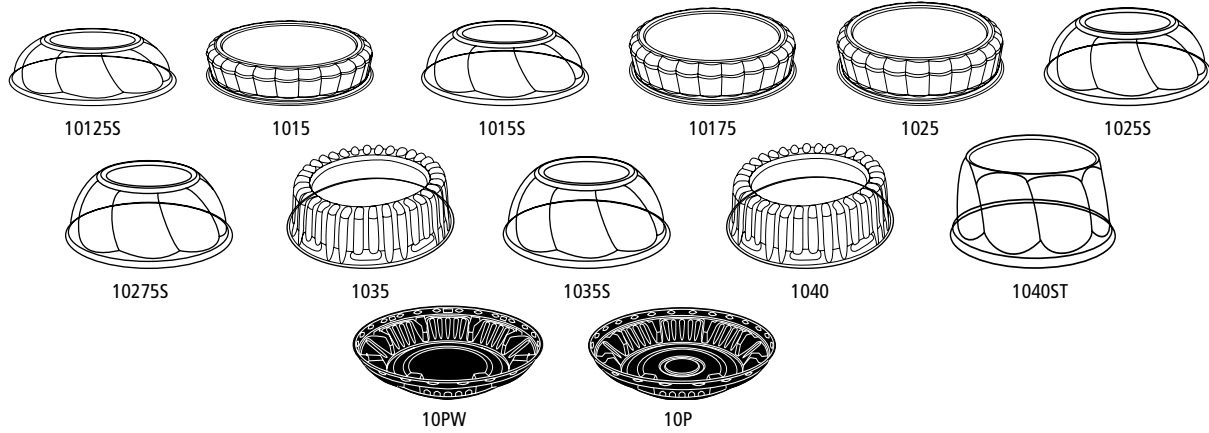

**9" Pie Packaging – APET – Combo**

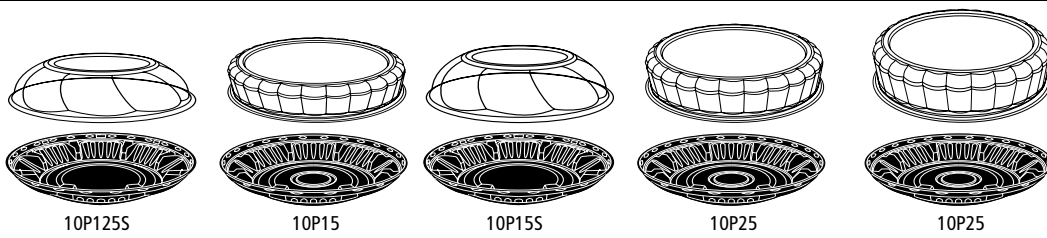

**10" Pie Packaging – APET – Bulk**

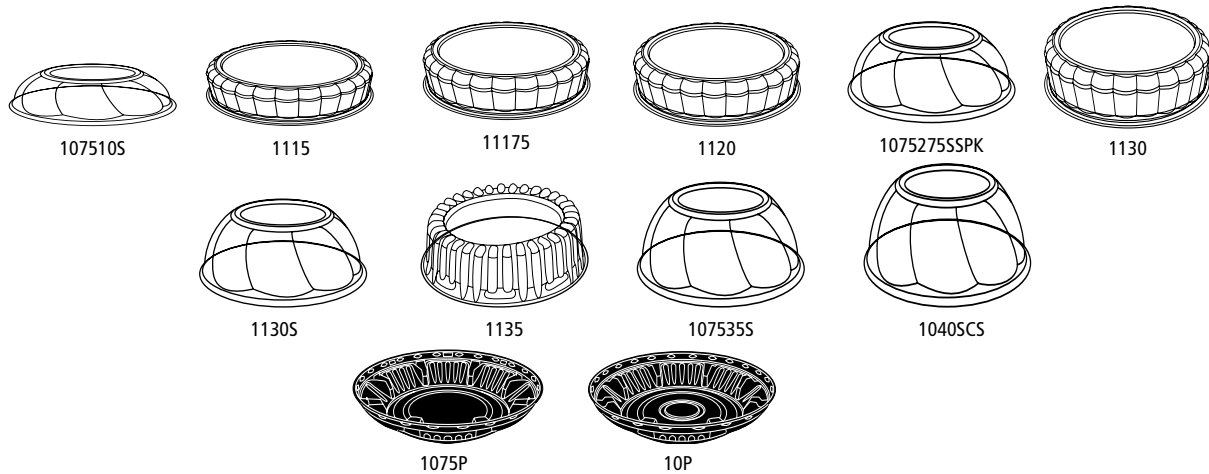

**10" Pie Packaging – APET – Combo**

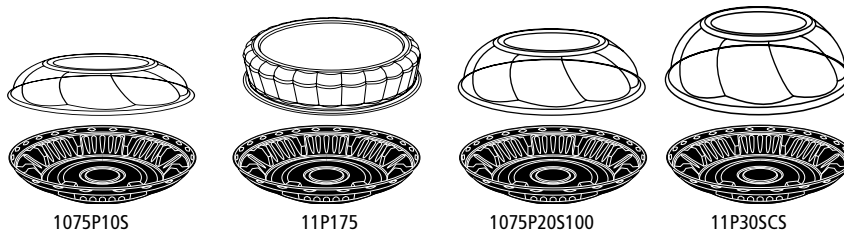

**12" Pie Packaging – APET – Bulk & Combo**

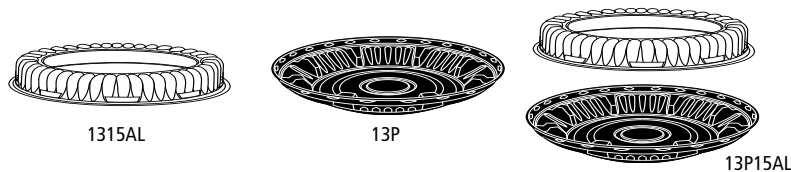



### 9" Pie Packaging – APET – Bulk

Product Number	Description	Dimensions (in inches)	Case Cube	Case Approx. Wt.	Case Pack
<b>Domes - Bulk</b>					
10125S	1.25" Tall Swirl Dome for 9" Pie	9 3/4 x 1 1/4	4.50	15.00	200
1015	1.5" Tall Fluted Dome for 9" Pie	9 3/4 x 1 1/2	3.40	13.00	200
1015S	1.5" Tall Swirl Dome for 9" Pie	9 3/4 x 1 1/2	4.50	15.00	200
10175	1.75" Tall Fluted Dome for 9" Pie	9 3/4 x 1 3/4	4.50	15.00	200
1025	2.5" Tall Fluted Dome for 9" Pie	9 3/4 x 2 1/2	4.50	16.00	200
1025S	2.5" Tall Swirl Dome for 9" Pie	9 3/4 x 2 1/2	4.50	16.00	200
10275S	2.75" Tall Swirl Dome for 9" Pie	9 3/4 x 2 3/4	4.50	16.00	200
1035	3.5" Tall Fluted Dome for 9" Pie	9 3/4 x 3 1/2	5.60	18.00	200
1035S	3.5" Tall Swirl Dome for 9" Pie	9 3/4 x 3 1/2	5.60	24.00	200
1040	4" Tall Fluted Dome for 9" Pie	9 3/4 x 4	5.60	22.00	200
1040ST	4" Tall Tapered Swirl Dome for 9" Pie	9 3/4 x 4	5.60	22.00	200
<b>Bases - Bulk</b>					
10PW	Black Base for 1" Deep for 9" Pie	10	4.50	16.00	200
10P	Black Base for 1 1/8" Deep for 9" Pie	9 7/8	4.50	16.00	200

### 9" Pie Packaging – APET – Combo

Product Number	Description	Dimensions (in inches)	Case Cube	Case Approx. Wt.	Case Pack
10P125S	1.25" Tall Swirl Dome w/Black Pie Base for 9" Pie	9 3/4 x 1 1/4	4.50	16.00	100 Combo
10P15	1.5" Tall Fluted Dome w/Black Pie Base for 9" Pie	9 3/4 x 1 1/2	4.50	15.00	100 Combo
10P15S	1.5" Tall Swirl Dome w/Black Pie Base for 9" Pie	9 3/4 x 1 1/2	4.50	16.00	100 Combo
10P25	2.5" Tall Fluted Dome w/Black Pie Base for 9" Pie	9 3/4 x 2 1/2	4.50	16.00	100 Combo
10P35	3.5" Tall Fluted Dome w/Black Pie Base for 9" Pie	9 3/4 x 3 1/2	4.50	17.00	100 Combo

### 10" Pie Packaging – APET – Bulk

Product Number	Description	Dimensions (in inches)	Case Cube	Case Approx. Wt.	Case Pack
<b>Domes - Bulk</b>					
107510S	1" Tall Swirl Dome for 10" Pie	10 3/4 x 1	4.20	18.00	200
1115	1.5" Tall Fluted Dome for 10" Pie	11 1/4 x 1 1/2	3.00	9.00	100
11175	1.75" Tall Fluted Dome for 10" Pie	11 1/4 x 1 3/4	3.00	10.00	100
1120	2" Tall Fluted Dome for 10" Pie	11 1/4 x 2	4.20	10.00	100
1075275SSPK	2.75" Tall Swirl Dome for 10" Pie	10 3/4 x 2 3/4	4.20	10.00	100
1130	3" Tall Fluted Dome for 10" Pie	11 1/4 x 3	4.20	11.00	100
1130S	3" Tall Swirl Dome for 10" Pie	11 1/4 x 3	4.20	14.00	100
1135	3.5" Tall Fluted Dome for 10" Pie	11 1/4 x 3 1/2	4.20	14.00	100
107535S	3.5" Tall Swirl Dome for 10" Pie	10 3/4 x 3 1/2	4.20	16.00	100
1040SCS	4" Tall Swirl Dome w/Crust Saver Feature for 10" Pie	11 1/4 x 4	3.00	14.00	100
<b>Bases - Bulk</b>					
1075P	Black Base for 10" Pie	11 1/8	4.20	20.00	200
1075PMD	Black Base w/Medium Ring for 10" Pie	11 1/8	4.20	20.00	200
11P	Black Base for 10" Pie	11 5/8	3.00	11.00	100

### 10" Pie Packaging – APET – Combo

Product Number	Description	Dimensions (in inches)	Case Cube	Case Approx. Wt.	Case Pack
1075P10S	1" Tall Swirl Dome w/Black Pie Base for 10" Pie	10 3/4 x 1	4.20	19.00	100 Combo
11P175	1.75" Tall Fluted Dome w/Black Pie Base for 10" Pie	11 1/4 x 1 3/4	3.00	10.00	50 Combo
1075P20S100	2" Tall Swirl Dome w/Black Pie Base for 10" Pie	10 3/4 x 2	4.20	19.00	100 Combo
11P30SCS	3" Tall Swirl Crust Saver Dome w/Black Pie Base for 10" Pie	11 1/4 x 3	3.00	11.00	50 Combo

### 12" Pie Packaging – APET – Bulk & Combo

Product Number	Description	Dimensions (in inches)	Case Cube	Case Approx. Wt.	Case Pack
1315AL	1.5" Tall Fluted Dome w/Recessed Top for 12" Pie	12 4/7 x 1 1/2	3.60	11.00	100 Bulk
13P	Black Pie Base for 12" Pie	13	3.60	13.00	100 Bulk
13P15AL	1.5" Tall Fluted Dome w/Recessed Top w/Black Pie Base for 10" Pie	12 4/7 x 1 1/2	3.60	12.00	50 Combo

# Beverage Packaging

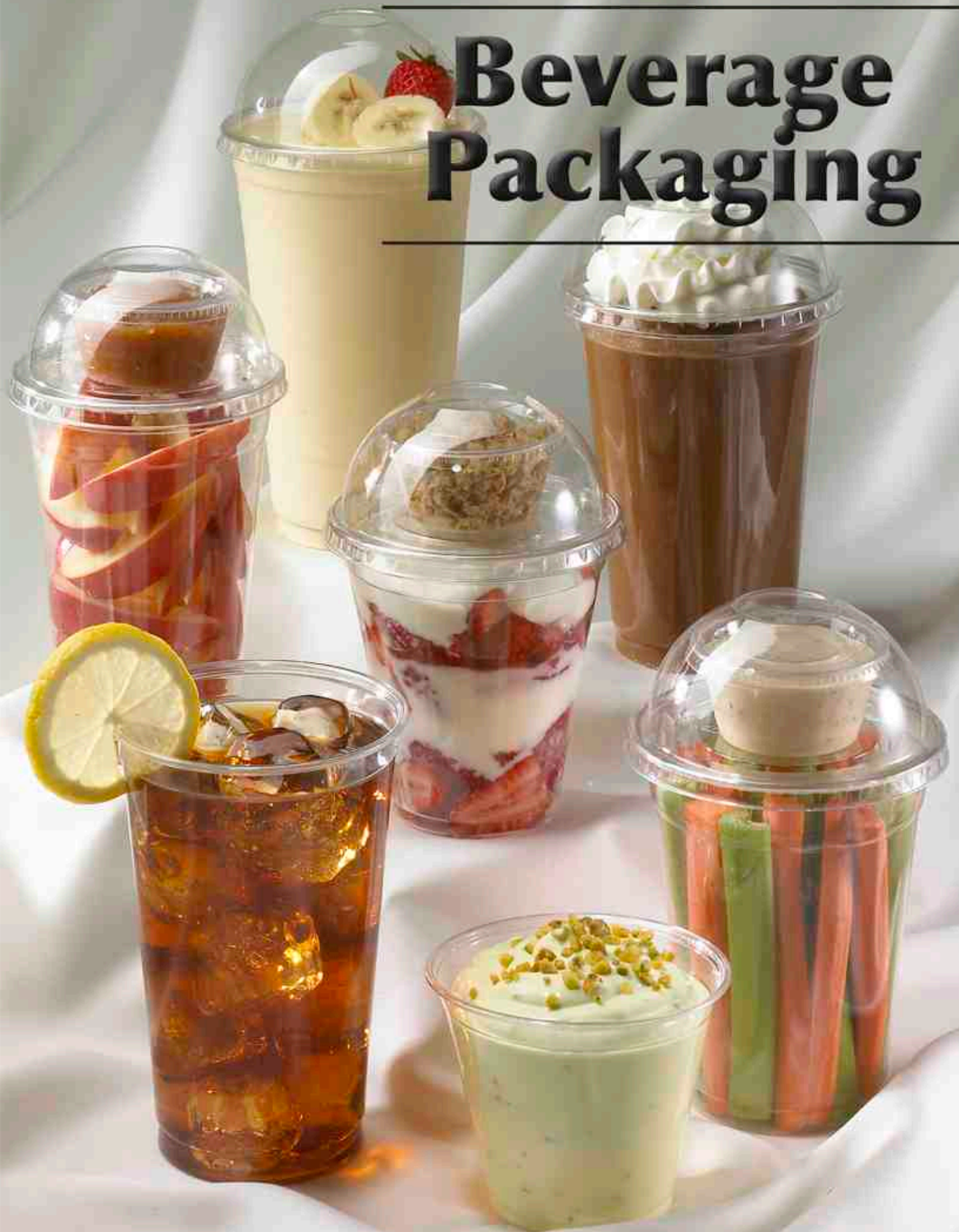

Product Number	Description	Page	Product Number	Description	Page
13865	10C OZ. HOT CUP TEAR-BACK LID - WHITE.....	B7	YE7	7 OZ. TRANSLUCENT CUP .....	B3
D10CHCREV	COFFEE REVOLUTION 10C OZ. HOT CUP .....	B7	YE9	9 OZ. TRANSLUCENT CUP .....	B3
D10CHCIMP	IMPACT 10C OZ. HOT CUP .....	B7	YF8EC	8 OZ. REPS PRINTED FOAM HOT CUP .....	B9
D10CHCSWL	SWIRL 10C OZ. HOT CUP .....	B7	YF812EC	12 OZ. REPS PRINTED FOAM HOT CUP .....	B9
D10SHCIMP	IMPACT 16 OZ. HOT CUP .....	B7	YF816EC	16 OZ. REPS PRINTED FOAM HOT CUP .....	B9
D10SHCREV	COFFEE REVOLUTION 10S OZ. HOT CUP .....	B7	YF820EC	20 OZ. REPS PRINTED FOAM HOT CUP .....	B9
D10SHCW	WHITE 10S OZ. HOT CUP .....	B7	YHCL12ENV	12 OZ. LABELED HOT CUP - SAVORTM DESIGN .....	B3
D10SHCSWL	SWIRL 10S OZ. HOT CUP .....	B7	YHCL16ENV	16 OZ. LABELED HOT CUP - SAVORTM DESIGN .....	B3
D12CCCC	COKE 12S OZ. COLD CUP .....	B9	YHCL20ENV	20 OZ. LABELED HOT CUP - SAVORTM DESIGN .....	B3
D12CCIMP	IMPACT 12 OZ. COLD CUP .....	B9	YHCL24ENV	12 OZ. LABELED HOT CUP - SAVORTM DESIGN .....	B3
D12SCCIMP	IMPACT 12S OZ. COLD CUP .....	B9	YHCL8ENV	8 OZ. LABELED HOT CUP - SAVORTM DESIGN .....	B3
D12THCW	WHITE 12T OZ. HOT CUP .....	B7	YLE7	NATURAL FLAT LID W/STRAW SLOT FOR 7 OZ. CUP .....	B3
D12THCSWL	SWIRL 12T OZ. HOT CUP .....	B7	YLE9	NATURAL FLAT LID W/STRAW SLOT FOR 9 & 10 OZ. CUPS .....	B3
D12THCREV	COFFEE REVOLUTION 12T OZ. HOT CUP .....	B7	YLEFA	A RIM REPS FLAT LID .....	B9
D12THCIMP	IMPACT 12T OZ. HOT CUP .....	B7	YLEB	B RIM REPS FLAT LID .....	B9
D16CCCC	COKE 16 OZ. COLD CUP .....	B9	YLHCFW	A RIM REPS DOME LID .....	B9
D16CCIMP	IMPACT 16 OZ. COLD CUP .....	B9	YLHCFBW	B RIM REPS DOME LID .....	B9
D16HCREV	COFFEE REVOLUTION 16 OZ. HOT CUP .....	B7	YLET20C	PS FLAT LID W/STRAW SLOT FOR PP T SERIES CUP .....	B5
D16HCW	WHITE 16 OZ. HOT CUP .....	B7	YLEQ32RB	HIPS FLAT LID FOR Q CAR CUPS .....	B11
D16HCSWL	SWIRL 16 OZ. HOT CUP .....	B7	YLER44RB	HIPS FLAT LID FOR R CAR CUPS .....	B11
D20HCIMP	IMPACT 20 OZ. HOT CUP .....	B7	YLHC8EOC	DOME SIPPER LID FOR 7- 8 OZ. CUPS - EBONY .....	B3
D20HCREV	COFFEE REVOLUTION 20 OZ. HOT CUP .....	B7	YLP10C	CLEAR FLAT LID W/STRAW SLOT (FITS 10 OZ. CUP) .....	B5
D20HCW	WHITE 20 OZ. HOT CUP .....	B7	YLP10CNH	CLEAR FLAT LID NO STW SLOT FOR 9 & 10 OZ CUPS .....	B5
D20HCSWL	SWIRL 20 OZ. HOT CUP .....	B7	YLP16C	CLEAR FLAT LID W/STRAW SLOT FOR 9 & 12 OZ. CUPS .....	B3,B5
D22CCCC	COKE 22 OZ. COLD CUP .....	B9	YLP20C	CLEAR FLAT LID W/STRAW SLOT (FITS 9, 12-14, 20 OZ. CUPS) .....	B5
D22CCIMP	IMPACT 22 OZ. COLD CUP .....	B9	YLP20CNH	CLEAR FLAT LID NO STW SLOT FOR 20 OZ CUP .....	B5
D24CCIMP	IMPACT 24 OZ. COLD CUP .....	B9	YLP22C	CLEAR FLAT LID W/STRAW SLOT FOR 16 OZ. CUP .....	B5
D24HCREV	COFFEE REVOLUTION 24 OZ. HOT CUP .....	B7	YLP24C	CLEAR FLAT LID W/STRAW SLOT (FITS 16, 24 OZ. CUPS) .....	B5
D24HCW	WHITE 24 OZ. HOT CUP .....	B7	YLP24CNH	CLEAR FLAT LID NO STW SLOT FOR 24 OZ CUP .....	B5
D24HCSWL	SWIRL 24 OZ. HOT CUP .....	B7	YLP32C	CLEAR FLAT LID W/STRAW SLOT (FITS 32 OZ. CUP) .....	B5
D24CPCRY	2/4 CUP CARRIER - UP TO 32 OZ. ....	B9	YLP5C	CLEAR FLAT LID W/STRAW SLOT FOR 5.5 OZ. CUP .....	B3
D24CPCRY44	2/4 CUP CARRIER - UP TO 44 OZ. ....	B9	YPLA24C	PLA CLEAR FLAT LID W/STRAW SLOT - B SERIES .....	B5
D24CCCC	COKE 24 OZ. COLD CUP .....	B9	YM51CC32	4-CUP CRUISER MOVER™ CLUB PACK (8-32 OZ) .....	B3
D32CCCC	COKE 32 OZ. COLD CUP .....	B9	YM527535	2-CUP CARRY-OUT TRAY (8-24 OZ.) .....	B3
D32CCIMP	IMPACT 32 OZ. COLD CUP .....	B9	YM527651	2-PLUS CARRY-OUT TRAY (8-46 OZ.) .....	B3
D4CPCRY	4 CUP CARRIER - UP TO 32 OZ. ....	B9	YP10C	10 OZ. CLEAR PLASTIC CUP .....	B5
D4CPCRY44	4 CUP CARRIER - UP TO 44 OZ. ....	B9	YP12C	12 OZ. TALL CLEAR PLASTIC CUP .....	B5
D4HCW	WHITE 4 OZ. HOT CUP .....	B7	YP1214C	12 - 14 OZ. CLEAR PLASTIC CUP .....	B5
D4HCREV	COFFEE REVOLUTION 4 OZ. HOT CUP .....	B7	YP1412C	14 - 12 OZ. CLEAR PLASTIC CUP .....	B5
D4CCCC	COKE 44 OZ. COLD CUP .....	B9	YP160C	16 - 18 OZ. CLEAR PLASTIC CUP .....	B5
D8HCIMP	IMPACT 8 OZ. HOT CUP .....	B7	YP162C	16 OZ. TALL CLEAR PLASTIC CUP .....	B5
D8HCREV	COFFEE REVOLUTION 8 OZ. HOT CUP .....	B7	YP20C	20 OZ. CLEAR PLASTIC CUP .....	B5
D8HCW	WHITE 8 OZ. HOT CUP .....	B7	YP21C	20 OZ. SQUAT CLEAR PLASTIC CUP .....	B5
D8HCSWL	SWIRL 8 OZ. HOT CUP .....	B7	YP24C	24 OZ. CLEAR PLASTIC CUP .....	B5
DDL4WD	4 OZ. HOT CUP DOME LID - WHITE .....	B7	YP32C	32 OZ. CLEAR PLASTIC CUP .....	B5
DDL122CLR	12S/16/20/22 OZ. COLD CUP CLEAR DOME LID .....	B9	YP7C	7 OZ. CLEAR PLASTIC CUP .....	B5
DDL124BLD	10S-24 OZ. HOT CUP DOME LID - BLACK .....	B7	YP9C	9 OZ. CLEAR PLASTIC CUP .....	B5
DDL124BRD	10S-24 OZ. HOT CUP DOME LID - BROWN .....	B7	YP90C	9 OZ. TALL CLEAR PLASTIC CUP .....	B5
DDL124WD	10S-24 OZ. HOT CUP DOME LID - WHITE .....	B7	YDDL10C	CLEAR DOME LID W/SMALL HOLE FOR 10 OZ. CUPS .....	B5
DDL8WD	8 OZ. HOT CUP DOME LID - WHITE .....	B7	YDDL10CLH	CLEAR DOME LID W/LARGE HOLE FOR 10 OZ. CUPS .....	B5
DFL124TBW	10S-24 OZ. HOT CUP TEAR-BACK LID - WHITE .....	B7	YDDL20C	CLEAR DOME LID W/HOLE (FITS 12, 20 OZ. CUPS) .....	B5
DFL122	12 OZ. COLD CUP LID .....	B9	YDDL20CLH	CLEAR DOME LID W/ LARGE HOLE FOR 5 OZ SUNDAE, 9,12/14,16 TALL, & 20 OZ CUPS .....	B5
DFL122Z	12S/16/20/22 OZ. COLD CUP LID .....	B9	YDDL20CNH	CLEAR DOME LID NO HOLE (FITS 12, 20 OZ. CUPS) .....	B5
DFL124TBRR	10S-24 OZ. HOT CUP TEAR-BACK LID - BROWN .....	B7	YDDL24C	CLEAR DOME LID W/HOLE (FITS 16, 24 OZ. CUPS) .....	B5
DFL32	32 OZ. COLD CUP LID .....	B9	YDDL24CLH	CLEAR DOME LID W/ LARGE HOLE FOR 12 OZ SUNDAE, 16, & 24 OZ CUPS .....	B5
DFL44	44 OZ. COLD CUP LID .....	B9	YDDL24CNH	CLEAR DOME LID NO HOLE (FITS 16, 24 OZ. CUPS) .....	B5
DFL24	24 OZ. COLD CUP LID .....	B9	YPHC10EC	10 OZ. PLA LINED HOT CUP .....	B11
DFL122	12S/16/20/22 OZ. COLD CUP LID .....	B9	YPHC12EC	12 OZ. PLA LINED HOT CUP .....	B11
DFL8TBW	8 OZ. HOT CUP TEAR-BACK LID - WHITE .....	B7	YPHC16EC	16 OZ. PLA LINED HOT CUP .....	B11
DP15922	IMPACT 10S OZ. HOT CUP .....	B7	YPHC20EC	20 OZ. PLA LINED HOT CUP .....	B11
DP19664	COKE 16T OZ. COLD CUP .....	B9	YPHC8EC	8 OZ. PLA LINED HOT CUP .....	B11
DP4871	32 OZ. COLD CUP CLEAR DOME LID .....	B9	YPLA1412C	12 - 14 OZ. PLA CLEAR DRINK CUP .....	B5
DP6930	WHITE 10C OZ. HOT CUP .....	B7	YPLA1412CEC	12 - 14 OZ. PLA CLEAR PRINTED DRINK CUP .....	B5
DSLVRN	KRAFT HOT CUP SLEEVE .....	B7	YPLA160C	16 - 18 OZ. PLA CLEAR DRINK CUP .....	B5
DSLVSWL	SWIRL HOT CUP SLEEVE .....	B7	YPLA160CEC	16 - 18 OZ. PLA CLEAR PRINTED DRINK CUP .....	B5
DSLWV	WHITE HOT CUP SLEEVE .....	B7	YPLA21C	20 OZ. PLA CLEAR DRINK CUP .....	B5
EC2000	EARTYCHOICE® RECYCLED COFFEE JACKET .....	B11	YPLA21CEC	20 OZ. PLA CLEAR PRINTED DRINK CUP .....	B5
LCPLA16	CPLA LID FOR 10, 12, 16, & 20 OZ. HOT CUPS .....	B11	YPLA24C	24 OZ. PLA CLEAR DRINK CUP .....	B5
YLHC16E	DOME SIP LID W/LOCK BACK TAB FOR 12 - 24 OZ. CUP - EBONY .....	B3	YPLA24CEC	24 OZ. PLA CLEAR PRINTED DRINK CUP .....	B5
LPHC16E	EBONY DOME LID FOR 10,12, 16 & 20 OZ. HOT CUPS .....	B11	YPLA9CEC	9 OZ. PLA CLEAR PRINTED DRINK CUP .....	B5
LPHC16W	WHITE DOME LID FOR 10,12, 16 & 20 OZ. HOT CUPS .....	B11	YPLADL24C	PLA CLEAR DOME LID W/HOLE - B SERIES .....	B5
LPHC8W	WHITE DOME LID FOR 8 OZ. HOT CUP .....	B11	YPM32C	32 OZ. CLEAR PLASTIC MOTOR CUP .....	B5
LPHSC8WEC	8 OZ. HOT SOUP CUP LID .....	B11	YPS12C	12 OZ. CLEAR PLASTIC SUNDAE CUP .....	B5
LPHSC16WEC	12, 16, 32 OZ. HOT SOUP CUP LID .....	B11	YPS45C	4.5 OZ. CLEAR PLASTIC SUNDAE CUP .....	B5
M510032	4-CUP CRUISER MOVER™ BEVERAGE CARRIER E (8-32 OZ.) .....	B3	YPS5C	5 OZ. CLEAR PLASTIC SUNDAE CUP .....	B5
M5135040001	4-PLUS® CUP CARRIER (8-46 OZ.) .....	B3	YPS8C	8 OZ. CLEAR PLASTIC SUNDAE CUP .....	B5
M5135080001	4-PLUS® CUP CARRIER CLUB PACK (8-46 OZ.) .....	B3	YPP1412N2	14/12 OZ. NATURAL PP DRINK CUP .....	B5
M527543	4-CUP CARRY-OUT TRAY (8-24 OZ.) .....	B3	YPP160N	16/18 OZ. NATURAL PP DRINK CUP .....	B5
PHSC12EC	12 OZ. PLA LINED HOT SOUP CUP .....	B11	YPP20N	20 OZ. NATURAL PP DRINK CUP .....	B5
PHSC16EC	16 OZ. PLA LINED HOT SOUP CUP .....	B11	YPP24N	24 OZ. NATURAL PP DRINK CUP .....	B5
PHSC32EC	32 OZ. PLA LINED HOT SOUP CUP .....	B11	YPPDL24N	NATURAL PP DOME LID W/HOLE FOR B SERIES CUP .....	B5
PHSC8EC	8 OZ. PLA LINED HOT SOUP CUP .....	B11	YPLL24N	NATURAL PP FLAT LID W/STRAW SLOT FOR B SERIES CUP .....	B5
STPLAW1754EC	EARTHCHOICE® GREEN DRINK STRAW - 7.75" JUMBO WRAPPED .....	B13	YPPM40N	40 OZ. NATURAL PP R DIA. CAR CUP .....	B11
STPLAW17724EC	EARTHCHOICE® GREEN DRINK STRAW - 7.75" JUMBO WRAPPED .....	B13	YPPM42N	42 OZ. NATURAL PP R DIA. CAR CUP .....	B11
STPLAWJ9516EC	EARTHCHOICE® GREEN DRINK STRAW - 7.75" JUMBO WRAPPED .....	B13	YPPM44N	44 OZ. NATURAL PP R DIA. CAR CUP .....	B11
YC1214	12 - 14 OZ. TRANSLUCENT CUP .....	B3	YPPM40W	40 OZ. WHITE PP R DIA. CAR CUP .....	B11
YC20	20 OZ. TRANSLUCENT CUP .....	B3	YPPM42W	42 OZ. WHITE PP R DIA. CAR CUP .....	B11
YE10	10 OZ. TRANSLUCENT CUP .....	B3	YPPM44W	44 OZ. WHITE PP R DIA. CAR CUP .....	B11
YE12	12 OZ. TRANSLUCENT CUP .....	B3	YPPMQ301N	30 OZ. NATURAL PP Q DIA. CAR CUP .....	B11
YE14	14 OZ. TRANSLUCENT CUP .....	B3	YPPMQ321N	32 OZ. NATURAL PP Q DIA. CAR CUP .....	B11
YE160	16 OZ. TRANSLUCENT CUP .....	B3	YPPMQ301W	30 OZ. WHITE PP Q DIA. CAR CUP .....	B11
YE3	3 OZ. TRANSLUCENT CUP .....	B3	YPPMQ321W	32 OZ. WHITE PP Q DIA. CAR CUP .....	B11
YE5	5 OZ. TRANSLUCENT CUP .....	B3	YPPY9N	9 OZ. NATURAL PP SQUAT DRINK CUP .....	B5

## Envelop<sup>®</sup> Savor<sup>™</sup> Foam Cups – Flat Lid & Dome Sip Lids



## Molded Fiber Carry-Safe<sup>®</sup> Beverage Carriers

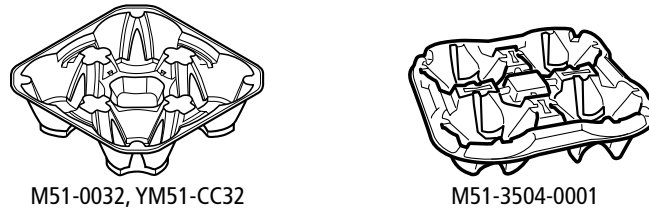

## Molded Fiber Carry-Safe<sup>®</sup> Carry-Out Trays

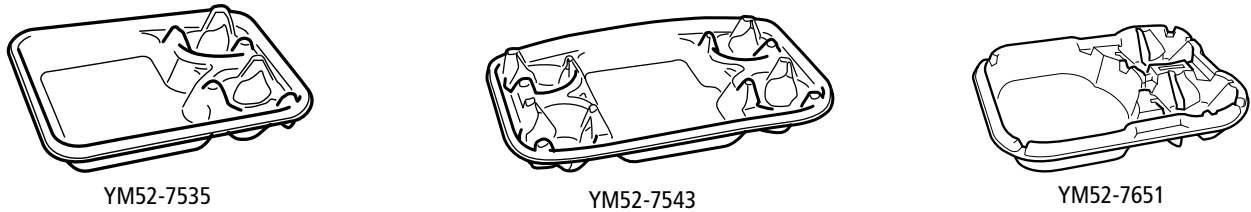

## Translucent Cups and Lids

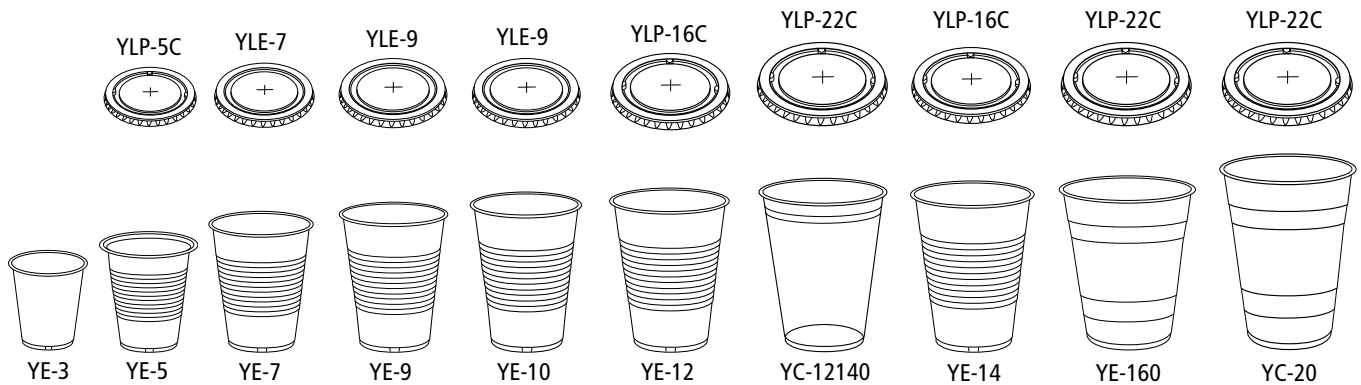

## Envellop® Savor™ Foam Cups – Flat Lid & Dome Sip Lids

Product Number	Description	Capacity (fl. oz.)	Cube	Case		Packing		Ti/Hi	Cases/ Unit Load
				Approx Wt.	Sleeve	Case	Sleeve		
YHCL8ENV	8 oz. Labeled Hot Cup - Savor™ Design	8	3.42	9.24	21/35	735	8/2	16	
YHCL12ENV	12 oz. Labeled Hot Cup - Savor™ Design	12	5.05	15.50	24/35	840	6/2	12	
YHCL16ENV	16 oz. Labeled Hot Cup - Savor™ Design	16	3.28	10.30	15/28	420	8/2	16	
YHCL20ENV	20 oz. Labeled Hot Cup - Savor™ Design	20	5.05	14.30	24/20	480	6/2	12	
YHCL24ENV	24 oz. Labeled Hot Cup - Savor™ Design	24	4.91	11.70	24/15	360	6/2	12	
LHC8E	Dome Lid w/Lock Back Tab, Fits 8 oz. Cup - Ebony	--	1.56	7.00	20/50	1000	8/4	32	
YLHC16E	Dome Lid w/Lock Back Tab, Fits 12 - 24 oz. Cups - Ebony	--	1.99	9.50	18/50	900	7/4	28	

## Molded Fiber Carry-Safe® Beverage Carriers

Product Number	Description	Dimensions (in inches)		Vert. Depth (in inches)	Case Cube	Case Wt.	Sleeve	Case Pack	Cases/ Unit Load
		Top Out	Holds						
M510032	4-Cup Cruiser Mover™ Beverage Carrier (8-32 oz. cups)	8 5/8 x 8 5/8	8 - 32 oz.	2 3/8	4.00	25.97	1/300	300	18
YM51CC32	4-Cup Cruiser Mover™ Club Pack - 50/Slv. (8-32 oz. cups)	8 5/8 x 8 5/8	8 - 32 oz.	2 3/8	2.76	16.87	4/50	200	18
M5135040001	4 Plus® Cup Carrier (8-46 oz. cups)	10 1/2 x 10 1/2	8 - 46 oz.	2 1/4	4.38	23.70	4/33	132	12
M5135080001	4 Plus® Cup Carrier Club Pack - 33/Slv. (8-46 oz. cups)	10 1/2 x 10 1/2	8 - 46 oz.	2 1/4	4.38	23.70	4/33	132	12

## Molded Fiber Carry-Safe® Carry-Out Trays

Product Number	Description	Dimensions (in inches)		Vert. Depth (in inches)	Case Cube	Case Wt.	Sleeve	Case Pack	Cases/ Unit Load
		Top Out	Holds						
YM527535	2-Cup Carry-Out Tray (8-24 oz. cups)	9 7/8 x 8 5/8	8 - 24 oz.	1 3/4	2.54	16.88	2/100	200	24
YM527543	4-Cup Carry-Out Tray (8-24 oz. cups)	13 3/4 x 8 1/2	8 - 24 oz.	1 3/4	4.06	27.50	1/250	250	18
YM527651	2-Plus Carry-Out Tray (8-46 oz. cups)	13 x 10 1/2	8 - 46 oz.	2 1/4	3.93	23.70	2/50	100	16

## Translucent Cups and Lids

Product Number	Color	Description	Capacity (fl. oz.)	Lid Size	Case		Packing		Cases/ Unit Load
					Cube	Approx Wt.	Sleeve	Case	
YE-3	Natural	3 oz. Translucent Cup	3	N/A	1.51	16.00	30/80	2,400	33
YE-5	Natural	5 oz. Translucent Cup	5	L	2.12	19.75	27/90	2,430	25
YE-7	Natural	7 oz. Translucent Cup	7	I	2.23	18.00	28/70	1,960	24
YE-9	Natural	9 oz. Translucent Cup	9	J	3.40	30.50	25/100	2,500	14
YE-10	Natural	10 oz. Translucent Cup	10	J	3.40	35.25	25/100	2,500	14
YE-12	Natural	12 oz. Translucent Cup	12	E	1.83	14.00	15/57	855	27
YC-12140	Natural	12/14 oz. Translucent Cup	12 / 14	G	2.15	19.00	15/55	825	24
YE-14	Natural	14 oz. Translucent Cup	14	E	2.68	18.00	24/40	960	18
YE-160	Natural	16 oz. Translucent Cup	16	G	2.69	21.50	12/80	960	20
YC-20	Natural	20 oz. Translucent Cup	20	G	3.30	28.50	15/60	900	16

### Translucent Cup Lids

YLP-5C	Clear	Clear Flat Lid w/Straw Slot for 5 oz. Cup	--	L	1.32	8.50	30/75	2,250	40
YLE-7	Natural	Trans. Flat Lid w/Straw Slot for 7 oz. Cup	--	I	1.45	7.00	24/80	1,920	36
YLE-9	Natural	Trans. Flat Lid w/Straw Slot for 9 & 10 oz. Cups	--	J	1.97	8.50	25/84	2,100	28
YLP-16C	Clear	Clear Flat Lid w/Straw Slot for 12 & 14 oz. Cups	--	E	1.98	9.00	15/75	1,125	27
YLP-22C	Clear	Clear Flat Lid w/Straw Slot for 12/14, 16 & 20 oz. Cups	--	G	3.66	14.50	24/70	1,680	15

## PET Clear Cups and Lids

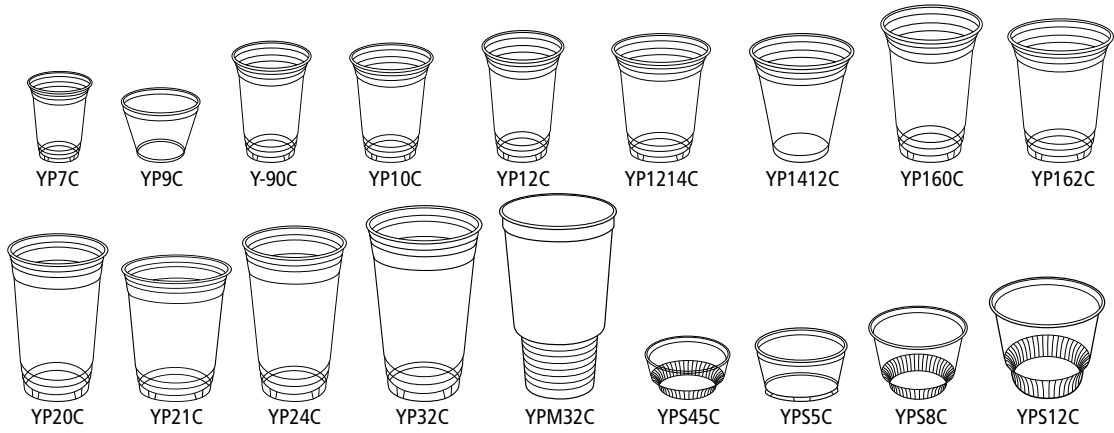

### A Lids

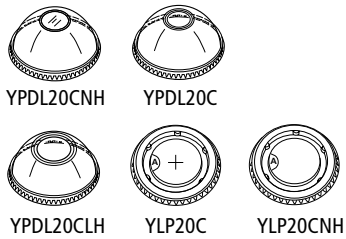

### B Lids

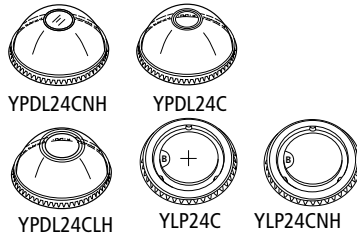

### C Lids

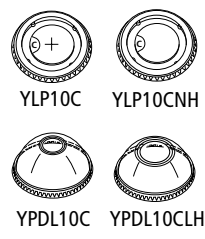

### D Lid



### E Lid



## PP Natural Cold Cups and Lids

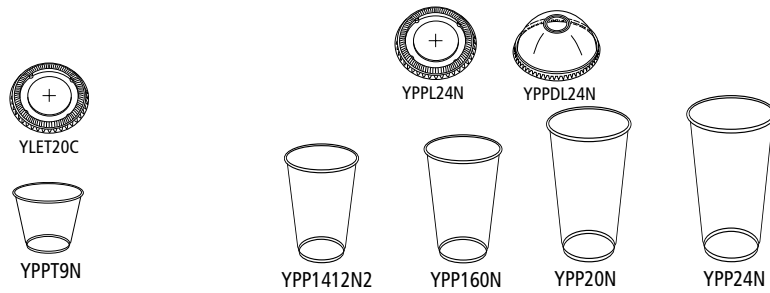

## EarthChoice® PLA Cups and Lids

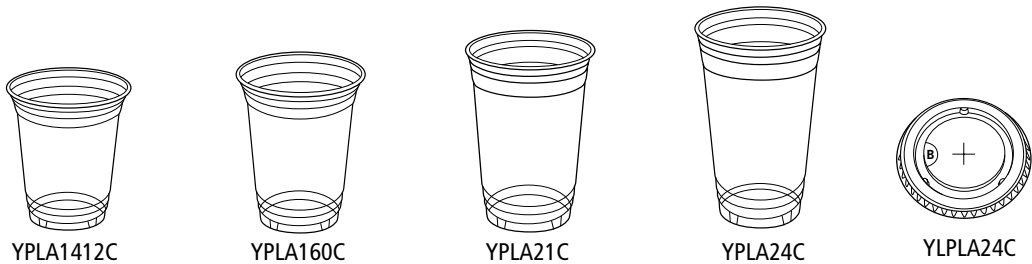

**PET Clear Cups and Lids**

Product Number	Description	Capacity (fl. oz.)	Lid Size	Cube	Case Approx Wt	Sleeve	Packing Case	Cases/ Unit Load
<b>Clear Cups</b>								
YP7C	7 oz. Clear PET Cup	7	--	1.80	19.00	20/50	1,000	30
YP9C	9 oz. Clear PET Squat Cup	9	A	2.05	24.50	15/65	975	24
YP90C	9 oz. Tall Clear PET Cup	9	C	1.88	19.25	20/45	900	27
YP10C	10 oz. Clear PET Cup	10	C	1.88	21.25	20/45	900	27
YP12C	12 oz. Tall Clear PET Cup	12	E	2.80	26.25	24/40	960	18
YP1214C	12 - 14 oz. Clear PET Cup	12 (Practical Fill) - 14 (Flush Fill)	A	1.88	17.60	9/60	540	28
YP1412C	14 - 12 oz. Clear PET Cup	14 - 12	B	2.23	24.25	10/70	700	24
YP160C	16 - 18 oz. Clear PET Cup	16 - 18	B	2.99	27.25	10/70	700	18
YP162C	16 oz. Tall Clear PET Cup	16	A	2.13	19.75	10/50	500	24
YP20C	20 oz. Clear PET Cup	20	A	2.51	23.75	10/50	500	18
YP21C	20 oz. Squat Clear PET Cup	20	B	2.95	27.75	10/60	600	18
YP24C	24 oz. Clear PET Cup	24	B	2.95	27.75	10/60	600	18
YP32C	32 oz. Clear PET Cup	32	D	2.09	18.25	6/40	240	24
YPM32C	32 oz. Clear PET Motor Cup	32	D	2.72	22.75	10/30	300	18
<b>Clear Sundae Cups</b>								
YPS45C	4.5 oz. Clear PET Sundae Dish	4.5	A	1.97	16.25	18/50	900	28
YPS5C	5 oz. Clear PET Sundae Dish	5	A	1.85	18.25	18/50	900	28
YPS8C	8 oz. Clear PET Sundae Dish	8	A	1.96	18.75	15/60	900	27
YPS12C	12 oz. Clear PET Sundae Dish	12	B	2.95	30.00	20/50	1,000	18
<b>Clear Cup Lids</b>								
YLP10C	Clear Flat Lid w/Straw Slot for 10 oz. Cup		C	0.93	6.25	12/80	960	56
YD10C	Clear Dome Lid w/Small Hole for 10 oz. Cup		C	1.04	6.20	10/100	1,000	54
YD10CLH	Clear Dome Lid w/Large Hole for 10 oz. Cup		C	1.04	6.20	10/100	1,000	54
YLP16C	Clear Flat Lid w/Straw Slot for 9 & 12 oz. Cups		E	1.98	9.00	15/75	1,125	27
YLP20C	Clear Flat Lid w/Straw Slot for 12-14 & 20 oz. Cups		A	1.76	8.25	12/85	1,020	30
YLP24C	Clear Flat Lid w/Straw Slot for 16 & 24 oz. Cups		B	1.98	9.00	12/85	1,020	24
YLP32C	Clear Flat Lid w/Straw Slot for 32 oz. Cup		D	2.57	10.35	13/75	975	21
YLP10CNH	Clear Flat Lid w/No Straw Slot for 9 & 10 oz. Cups		C	0.93	6.25	12/80	960	56
YD120C	Clear Dome Lid w/Sm Hole for 5 oz. Sundae, 9, 12/14, 16 Tall & 20 oz. Cups		A	1.73	9.00	12/75	900	30
YD120CNH	Clear Dome Lid w/No Hole for 12-14 & 20 oz. Cups		A	1.73	8.50	12/75	900	30
YD120CLH	Clear Dome Lid w/Lg. Hole for 5 oz. Sundae, 9,12/14,16 Tall & 20 oz. Cups		A	1.73	8.35	12/75	900	30
YLP20CNH	Clear Flat Lid w/No Straw Slot for 20 oz. Cup		A	1.78	8.25	12/85	1,020	30
YD124C	Clear Dome Lid w/Small Hole for 12oz. Sundae, 16 & 24 oz. Cups		B	2.01	9.25	12/75	900	24
YD124CLH	Clear Dome Lid w/Lg. Hole For 12 oz. Sundae, 16 & 24 oz. Cups		B	2.01	9.25	12/75	900	24
YLP24CNH	Clear Flat Lid w/No Straw Slot for 24 oz. Cup		B	1.98	9.00	12/85	1,020	24
YD124CNH	Clear Dome Lid w/No Hole for 16 & 24 oz. Cups		B	2.01	9.25	12/75	900	24

For custom printed Clear Drink Cups, please contact your Pactiv sales representative.

**PP Natural Cold Cups and Lids**

Product Number	Description	Capacity (fl. oz.)	Lid Size	Cube	Case Approx Wt	Sleeve	Packing Case	Cases/ Unit Load
YPP9N	9 oz. Natural PP Squat Drink Cup	9	T	1.81	10.50	30/25	750	27
YPP1412N2	14/12 oz. Natural PP Drink Cup	14/12	B	2.87	22.30	18/50	900	18
YPP160N	16/18 oz. Natural PP Drink Cup	16/18	B	2.96	20.50	20/35	700	18
YPP20N	20 oz. Natural PP Drink Cup	20	B	3.23	21.00	24/25	600	15
YPP24N	24 oz. Natural PP Drink Cup	24	B	3.53	21.40	24/25	600	15
<b>PP Drink Cup Lids</b>								
YLET20C	Clear PS Flat Lid w/Straw Slot for T Series Cup	--	T	1.72	5.75	8/125	1000	30
YPL24N	Natural PP Flat Lid w/Straw Slot for B Series Cup	--	B	1.84	7.49	12/80	960	24
YD124N	Natural PP Dome Lid w/Hole for B Series Cup	--	B	1.96	10.70	12/75	900	24

**EarthChoice® PLA Cups and Lids**

Product Number	Description	Case Wt.	Cube	Case Pack	Cases/ Unit Load
<b>Cold Drink Cups &amp; Lids</b>					
YPLA7C	7 oz. PLA Clear Unprinted Drink Cup	19.00	1.77	1,000	30
YPLA9C	9 oz. PLA Clear Unprinted Drink Cup	24.50	2.05	975	24
YPLA1412C	12 - 14 oz. PLA Clear Unprinted Drink Cup	23.50	2.20	680	24
YPLA160C	16 - 18 oz. PLA Clear Unprinted Drink Cup	26.80	2.67	696	20
YPLA21C	20 oz. PLA Clear Unprinted Drink Cup	28.30	2.92	600	18
YPLA24C	24 oz. PLA Clear Unprinted Drink Cup	26.90	2.94	580	18
YPLA9CEC	9 oz. PLA Clear Printed Drink Cup	19.00	1.77	975	30
YPLA1412CEC	12 - 14 oz. PLA Clear Printed Drink Cup	23.50	2.20	680	24
YPLA160CEC	16 - 18 oz. PLA Clear Printed Drink Cup	26.80	2.67	696	20
YPLA21CEC	20 oz. PLA Clear Printed Drink Cup	28.30	2.92	600	18
YPLA24CEC	24 oz. PLA Clear Printed Drink Cup	26.90	2.94	580	18
<b>Cold Drink Cup Lids</b>					
YPLA24C	PLA Clear Flat Lid w/Straw Slot - B Series	8.10	1.82	915	24
YPLADL24C	PLA Clear Dome Lid w/Hole - B Series	9.25	1.98	900	24

**Dopaco® Stock Hot Cups**

**White**

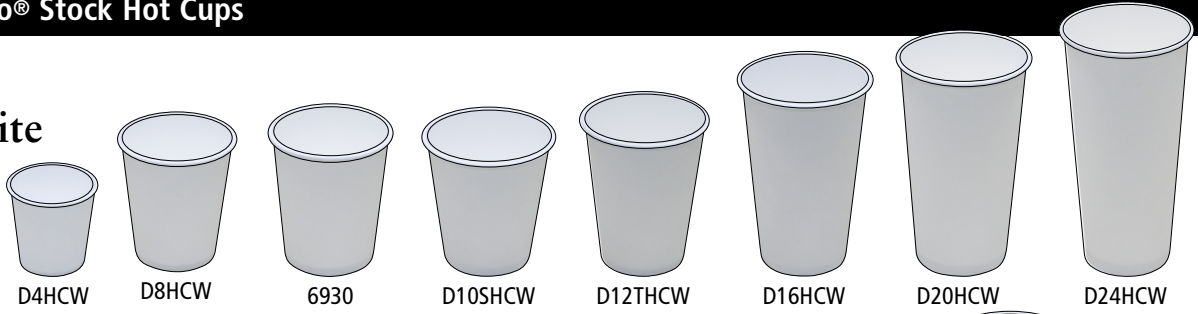

**Swirl**



**Impact**

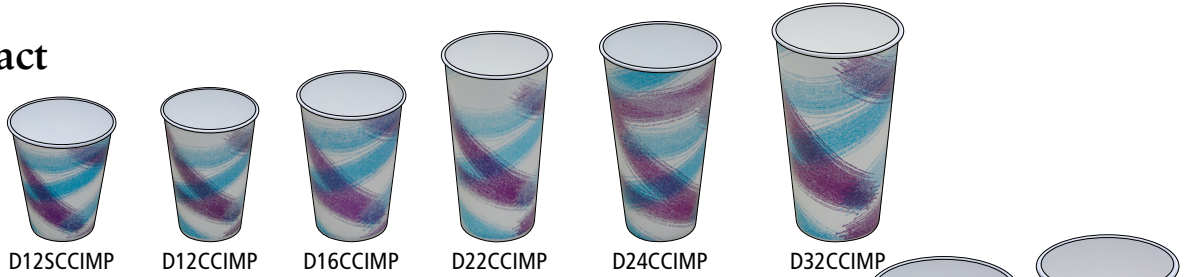

**Coffee Revolution**



**Dopaco® Stock Hot Cup Lids & Sleeves**





**Dopaco® Stock Hot Cups**

Product Number	Description	Capacity (fl. oz.)	Cube	Case Approx Wt.	Packing Sleeve	Case	Ti/Hi	Cases/ Unit Load
<b>White Hot Cups</b>								
D4HCW	4 oz. Hot Cup	4	0.96	16.00	20/50	1000	12/5	60
D8HCW	8 oz. Hot Cup	8	2.33	17.90	20/50	1000	9/4	36
6930	10C oz. Hot Cup	10	3.09	21.42	20/50	1000	8/4	32
D10SHCW	10S oz. Hot Cup	10	3.49	21.44	20/50	1000	6/4	24
D12THCW	12T oz. Hot Cup	12	3.13	25.71	20/50	1000	6/4	24
D16HCW	16 oz. Hot Cup	16	3.89	34.40	20/50	1000	6/3	18
D20HCW	20 oz. Hot Cup	20	2.70	22.40	20/25	500	6/4	24
D24HCW -	24 oz. Hot Cup	24	2.87	23.20	20/25	500	6/4	24
<b>Swirl Hot Cups</b>								
D8HCSWL	8 oz. Hot Cup	8	2.33	17.90	20/50	1000	9/4	36
D10CHCSWL	10C oz. Hot Cup	10	3.09	21.42	20/50	1000	8/4	32
D10SHCSWL	10S oz. Hot Cup	10	3.49	21.44	20/50	1000	6/4	24
D12THCSWL	12T oz. Hot Cup	12	3.13	25.71	20/50	1000	6/4	24
D16HCSWL	16 oz. Hot Cup	16	3.89	34.40	20/50	1000	6/3	18
D20HCSWL	20 oz. Hot Cup	20	2.70	22.40	20/25	500	6/4	24
D24HCSWL	24 oz. Hot Cup	24	2.87	23.20	20/25	500	6/4	24
<b>Impact Hot Cups</b>								
D8HCIMP	8 oz. Hot Cup	8	2.33	17.90	20/50	1000	9/4	36
D10HCIMP	10C oz. Hot Cup	10	3.09	21.42	20/50	1000	8/4	32
D10SHCIMP	10S oz. Hot Cup	10	3.49	21.44	20/50	1000	6/4	24
D12THCIMP	12T oz. Hot Cup	12	3.13	25.71	20/50	1000	6/4	24
D16HCIMP	16 oz. Hot Cup	16	3.89	34.40	20/50	1000	6/3	18
D20HCIMP	20 oz. Hot Cup	20	2.70	22.40	20/25	500	6/4	24
<b>Coffee Revolution Hot Cups</b>								
D4HCREV	4 oz. Hot Cup	4	0.96	16.00	20/50	1000	12/5	60
D8HCREV	8 oz. Hot Cup	8	2.33	17.90	20/50	1000	9/4	36
D10HCREV	10C oz. Hot Cup	10	3.09	21.42	20/50	1000	8/4	32
D10SHCREV	10S oz. Hot Cup	10	3.49	21.44	20/50	1000	6/4	24
D12THCREV	12T oz. Hot Cup	12	3.13	25.71	20/50	1000	6/4	24
D16HCREV	16 oz. Hot Cup	16	3.89	34.40	20/50	1000	6/3	18
D20HCREV	20 oz. Hot Cup	20	2.70	22.40	20/25	500	6/4	24
D24HCREV	24 oz. Hot Cup	24	2.87	23.20	20/25	500	6/4	24

**Dopaco® Stock Hot Cup Lids & Sleeves**

Product Number	Description	Cube	Case Approx Wt.	Packing Sleeve	Case	Ti/Hi	Cases/ Unit Load
<b>Hot Cups Lids</b>							
DDL4WD	4 oz. Dome Lid - White	0.82	4.00	10/100	1000	24/5	120
DFL8TBW	8 oz. Tear-Back Lid - White	1.30	5.00	10/100	1000	14/4	56
DDL8WD	8 oz. Dome Lid - White	1.30	6.30	10/100	1000	17/4	68
13865	10C oz. Tear-Back Lid - White	1.30	6.00	10/100	1000	14/4	56
DFL124TBW	10S-24 oz. Tear-Back Lid - White	1.50	6.50	10/100	1000	12/4	48
DFL124TBBR	10S-24 oz. Tear-Back Lid - Brown	1.50	7.60	10/100	1000	12/4	48
DDL124WD	10S-24 oz. Dome Lid - White	1.64	6.38	10/100	1000	12/4	48
DDL124BLD	10S-24 oz. Dome Lid -Black	1.64	6.38	10/100	1000	12/4	48
DDL124BRD	10S-24 oz. Dome Lid - Brown	1.64	6.38	10/100	1000	12/4	48
<b>Hot Cups Sleeves</b>							
DSL1VW	White Hot Cup Sleeve	1.00	19.00	--	1000	9/6	54
DSL1VSWL	Swirl Hot Cup Sleeve	1.00	18.00	--	1000	9/6	54
DSL1VBRN	Kraft Hot Cup Sleeve	1.00	18.00	--	1000	9/6	54

## Dopaco® Stock Cold Cups

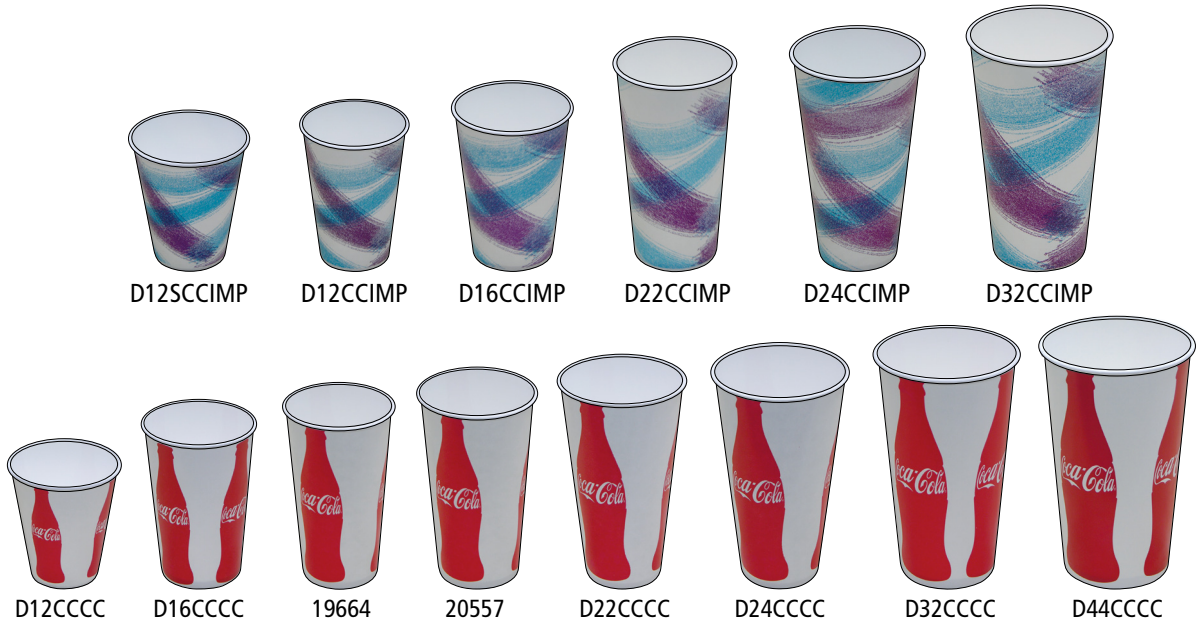

## Dopaco® Stock Cold Cup Lids

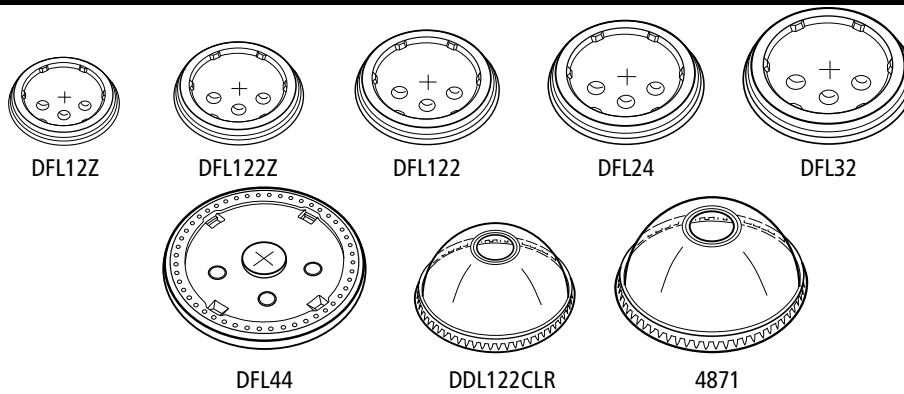

## Dopaco® Cup Carriers



## Dopaco® Cup Carriers



### Dopaco® Stock Cold Cups

Product Number	Description	Capacity (fl. oz.)	Cube	Case		Packing		Ti/Hi	Cases/ Unit Load
				Approx Wt.	Sleeve	Case			
D12SCCIMP	12S oz. Impact Cold Cup	12	2.20	22.69	16/75	1200		9/4	36
D12CCIMP	12 oz. Impact Cold Cup	12	4.10	47.76	30/80	2400		6/4	24
D16CCIMP	16 oz. Impact Cold Cup	16	3.40	29.28	24/50	1200		5/5	25
D22CCIMP	22 oz. Impact Cold Cup	22	4.30	38.30	24/50	1200		5/4	20
D24CCIMP	24 oz. Impact Cold Cup	24	4.70	38.90	24/50	1200		5/4	20
D32CCIMP	32 oz. Impact Cold Cup	32	3.78	28.40	15/40	600		6/4	24
D12CCCC	12S oz. Coke Cold Cup	12	2.20	22.69	16/75	1200		9/4	36
D16CCCC	16 oz. Coke Cold Cup	16	3.38	29.28	24/50	1200		5/5	25
19664	16T oz. Coke Cold Cup	16	4.60	34.74	24/50	1200		5/3	15
20557	20 oz. Coke Cold Cup	20	4.22	36.75	24/50	1200		6/4	24
D22CCCC	22 oz. Coke Cold Cup	22	4.30	38.30	24/50	1200		5/4	20
D24CCCC	24 oz. Coke Cold Cup	24	4.70	38.90	24/50	1200		5/4	20
D32CCCC	32 oz. Coke Cold Cup	32	3.78	28.40	15/40	600		6/4	24
D44CCCC	44 oz. Coke Cold Cup	44	6.13	35.70	24/25	600		4/3	12

### Dopaco® Stock Cold Cup Lids

Product Number	Description	Cube	Case		Packing		Ti/Hi	Cases/ Unit Load
			Approx Wt.	Sleeve	Case			
DFL12Z	12 oz. Cold Cup Lid	2.59	10.25	24/100	2400		6/6	36
DFL12ZZ	12S/16/20/22 oz. Cold Cup Lid	3.32	11.24	24/100	2400		6/5	30
DFL122	12S/16/20/22 oz. Cold Cup Lid	1.61	5.56	12/100	1200		11/5	55
DFL24	24 oz. Cold Cup Lid	2.16	6.35	12/100	1200		10/5	50
DFL32	32 oz. Cold Cup Lid	1.33	4.50	6/100	600		8/9	72
DFL44	44 oz. Cold Cup Lid	1.33	4.50	6/100	600		13/5	65
DDL122CLR	12S/16/20/22 oz. Cold Cup Clear Dome Lid	1.33	4.50	6/100	600		13/5	65
4871	32 oz. Cold Cup Clear Dome Lid	2.25	11.00	10/100	1000		10/4	40

### Dopaco® Cup Carriers

Product Number	Description	Cube	Case		Packing		Ti/Hi	Cases/ Unit Load
			Approx Wt.	Sleeve	Case			
DP2370	2/4 Cup Carrier - up to 32 oz.	1.37	17.95	--	250		8/8	64
DP5170	4 Cup Carrier - up to 32 oz.	2.21	32.00	--	200		7/6	42
DP8003	4 Cup Carrier - up to 44 oz.	1.52	31.10	--	150		6/6	36
DP19399	2/4 Cup Carrier - up to 44 oz.	2.07	25.80	--	250		5/6	30

### Dopaco® Cup Carriers

Item #	Description	Lid Fits	Case Cube	Case Weight	Case Count
YFA8EC	8 oz. REPS Printed Foam Hot Cup	FA	3.74	8.92	950
YFB12EC	12 oz. REPS Printed Foam Hot Cup	FB	6.21	10.91	1088
YFB16EC	16 oz. REPS Printed Foam Hot Cup	FB	6.78	11.11	700
YFB20EC	20 oz. REPS Printed Foam Hot Cup	FB	6.21	9.30	512
Cup Lids					
YLEFA	A Rim Flat Lid		1.05	4.92	1000
YLHCFW	A Rim Dome Lid		1.08	6.59	1000
YLEFB	B Rim Flat Lid		1.37	6.68	1000
YLHCFBW	B Rim Dome Lid		1.43	7.98	1000

## Advance™ Polypropylene Car Cups



## PLA Cold Drink Cups & Lid Product Specifications



## PLA Lined Hot Cup & Soup Cup Product Specifications



**Advance™ Polypropylene Car Cups**

Product #	Description	Capacity	Lid Size	Cube	Approx Wt.	Sleeve	Case	Cases/ Unit Load
YLEQ32RB	HIPS Flat Lid for Q CUPS	--	Q	2.22	7.7	8/125	1000	24
YLER44RB	HIPS Flat Lid for R CUPS	--	R	2.62	8.7	8/125	1000	20
YPPMQ301W	30oz WHITE PP Q-dia Top Stk Motor CUP	30	Q	2.59	16.5	10/30	300	20
YPPMQ301N	30oz NATURAL PP Q-dia Top Stk Motor CUP	30	Q	2.59	16.5	10/30	300	20
YPPMQ321W	32oz WHITE PP Q-dia Top Stk Motor CUP	32	Q	2.62	16.6	10/30	300	20
YPPMQ321N	32oz NATURAL PP Q-dia Top Stk Motor CUP	32	Q	2.62	16.6	10/30	300	20
YPPM40W	40oz WHITE PP R-dia Top Stk Motor CUP	40	R	3.12	17.2	10/29	290	16
YPPM40N	40oz NATURAL PP R-dia Top Stk Motor CUP	40	R	3.12	17.2	10/29	290	16
YPPM42W	42oz WHITE PP R-dia Top Stk Motor CUP	42	R	3.15	19.5	10/29	290	16
YPPM42N	42oz NATURAL PP R-dia Top Stk Motor CUP	42	R	3.15	19.5	10/29	290	16
YPPM44W	44oz WHITE PP R-dia Top Stk Motor CUP	44	R	3.12	18.8	10/27	270	16
YPPM44N	44oz NATURAL PP R-dia Top Stk Motor CUP	44	R	3.12	18.8	10/27	270	16

**PLA Cold Drink Cups & Lid Product Specifications**

Item Number	Description	Lid Size	Case Wt.	Cube	Sleeve	Cs. Pack	Cases/ Unit Load
<b>Cold Drink Cups</b>							
YPLA-7C	7 oz. PLA Clear Unprinted Drink Cup	A	19.00	1.74	20/50	1,000	60
YPLA-9C	9 oz. PLA Clear Unprinted Drink Cup	A	24.50	2.02	15/65	975	24
YPLA-1412C	12 - 14 oz. PLA Clear Unprinted Drink Cup	B	23.50	2.20	10/68	680	24
YPLA-160C	16 - 18 oz. PLA Clear Unprinted Drink Cup	B	26.80	2.67	6/116	696	20
YPLA-21C	20 oz. PLA Clear Unprinted Drink Cup	B	28.30	2.92	10/60	600	18
YPLA-24C	24 oz. PLA Clear Unprinted Drink Cup	B	26.90	2.92	10/58	580	18
YPLA-9CEC	9 oz. PLA Clear Printed Drink Cup	A	24.50	2.02	15/65	975	30
YPLA-1412CEC	12 - 14 oz. PLA Clear Printed Drink Cup	B	26.25	2.22	10/68	680	24
YPLA-160CEC	16 - 18 oz. PLA Clear Printed Drink Cup	B	26.80	2.67	6/116	696	20
YPLA-21CEC	20 oz. PLA Clear Printed Drink Cup	B	28.30	2.94	10/60	600	18
YPLA-24CEC	24 oz. PLA Clear Printed Drink Cup	B	26.90	2.92	10/58	580	18
<b>Cold Drink Cup Lids</b>							
YLPLA-20C	PLA Clear Flat Lid w/Straw Slot	A	8.25	1.76	12/85	1,020	24
YPLA-DL20CNH	PLA Clear Dome Lid w/No Hole	A	8.50	1.76	12/75	900	30
YLPLA-24C	PLA Clear Flat Lid w/Straw Slot	B	8.10	1.82	15/61	915	24
YPLA-DL24CNH	PLA Clear Dome Lid w/No Hole	B	8.50	1.98	12/75	900	24
YPLA-DL24C	PLA Clear Dome Lid w/Hole	B	9.25	1.98	12/75	900	24

**PLA Lined Hot Cup & Soup Cup Product Specifications**

Item Number	Description	Cube	Case Weight	Sleeve	Case Pack	Cases/ Unit Load
<b>Hot Cups (Compostable)</b>						
YPHC-8-EC	8 oz. PLA Lined Hot Cup	2.06	22.00	20/50	1,000	18
YPHC-10-EC	10 oz. PLA Lined Hot Cup	2.76	23.54	20/50	1,000	18
YPHC-12-EC	12 oz. PLA Lined Hot Cup	3.10	24.00	20/48	960	27
YPHC-16-EC	16 oz. PLA Lined Hot Cup	3.73	25.00	20/50	1,000	12
YPHC-20-EC	20 oz. PLA Lined Hot Cup	3.85	28.00	20/50	1,000	12
<b>Hot Cup Lids - PS</b>						
LPHC-8W	White Dome Lid for 8 oz. Cup	1.51	7.00	20/50	1,000	28
LPHC-16W	White Dome Lid for 10, 12, 16 & 20 oz. Cups	1.90	10.60	20/50	1,000	28
LPHC-16E	Ebony Dome Lid for 10, 12, 16 & 20 oz. Cups	1.90	10.60	20/50	1,000	28
<b>Hot Cup Lid - CPLA (Compostable)</b>						
LCPLA-16	CPLA Lid for 10, 12, 16, & 20 oz. Cups	1.90	10.60	20/50	1,000	28
<b>Hot Cup Sleeve</b>						
EC2000	EarthChoice® Recycled Coffee Jacket	0.60	13.80	--	1,300	40
<b>Soup Cups (Compostable)</b>						
PHSC-8EC	8 oz. PLA Lined Hot Soup Cup	3.27	29.50	20/50	1,300	40
PHSC-12EC	12 oz. PLA Lined Hot Soup Cup	2.93	24.00	20/25	500	30
PHSC-16EC	16 oz. PLA Lined Hot Soup Cup	4.01	25.00	20/25	500	30
PHSC-32EC	32 oz. PLA Lined Hot Soup Cup	2.74	24.20	20/25	500	8
<b>Soup Cup Lids - PP</b>						
LPHSC-8WEC	8 oz. Hot Soup Cup Lid	2.08	6.00	20/50	1,000	8
LPHSC-16WEC	12/16/32 oz. Hot Soup Cup Lid	3.53	11.20	20/25	500	12



**EarthChoice® PLA Straws**

Product #	Description	Case		Sleeve	Case	Cases/ Unit Load
		Cube	Approx Wt.			
STPLAW-J77-24-EC	EarthChoice® Green Drink Straw - 7.75" Jumbo Wrapped	3.92	14.30	20/500	10,000	18
STPLAW-J95-16-EC	EarthChoice® Green Drink Straw - 9.5" Jumbo Wrapped	4.71	18.70	20/500	10,000	18
STPLAW-J75-16-EC	EarthChoice® Green Drink Straw - 7.75" Jumbo Wrapped	4.30	26.00	24/500	12,000	20







# Catering Products



Product Number	Description	Page	Product Number	Description	Page
1012-30	1/2 SIZE METAL STEAM TABLE COVER.....	C3	P44125S	12" SUPER SHALLOW CATERWARE® CRYSTAL CUT™ DOME.....	C5
101230DG	GOLD FOIL COVER FOR HALF STEAM TABLE PANS.....	C3	P4416	16" CATERWARE CRYSTAL CUT™ DOME.....	C5
1012-30E	1/2 SIZE METAL STEAM TABLE COVER - COATED.....	C3	P4418	18" CATERWARE CRYSTAL CUT™ DOME.....	C5
1162-25	1/3 SIZE METAL STEAM TABLE COVER.....	C3	P4418Z	18" ORIGINAL STYLE CATERWARE® DOME.....	C5
1064DP3CLRL	10" 64 OZ PLATTER, DIP CUP, 3 CELLS, LEAK RESISTANT LID.....	C13	P6132	CLEAR COVER FOR HALF SIZE ALUMINUM PANS.....	C3
1064DP4CLRL	10" 64 OZ PLATTER, DIP CUP, 4 CELLS, LEAK RESISTANT LID.....	C13	P6174	SHELL SHAPED CATERBOWL® DOME.....	C5
1064DP4CVL	10" 64 OZ PLATTER, DIP CUP, 4 CELLS, VENTED LID.....	C13	P6182	SMALL SHELL SHAPED CATERBOWL JR DOME.....	C5
11X14124BDM4C	11 X 14" 124 OZ. BLACK PLATTER, 4 CELLS, MEDIUM DIP CUP.....	C13	P92220	CATERWARE CATERBOWL® DOME FOR 92220K.....	C7
11X145CILRL	INDIVIDUAL CELL LEAK RESISTANT LID.....	C13	P92230	CATERWARE CATERBOWL® DOME FOR 92230K.....	C7
13220DP4C	13" CLEAR PLATTER, 8 OZ. DIP CUP, 4 CELLS, LEAK RESISTANT.....	C13	P9812	12" CLEAR PLASTIC CATERWARE® DOME.....	C9
13220DP4C	13" CLEAR PLATTER, 8 OZ. DIP CUP, 4 CELLS, LEAK RESISTANT.....	C13	P9816	16" CLEAR PLASTIC CATERWARE® DOME.....	C9
1325DD4CJ	13" CLEAR PLATTER, 12 OZ. DIP CUP, 4 CELLS W/ JUICE TRAP, LEAK RESISTANT.....	C13	P9818	18" CLEAR PLASTIC CATERWARE® DOME.....	C9
1325DD4CJLD	13" CLEAR PLATTER, 12 OZ. DIP CUP, 4 CELLS W/ JUICE TRAP, LID.....	C13	PPC9Y	13" LID.....	C13
1325DD4CLD	13" CLEAR PLATTER, 12 OZ. DIP CUP, 4 CELLS, LID.....	C13	SAB0508	8 OZ. BLACK SQUARE BOWL BASE.....	C11
1325DP4C	13" CLEAR PLATTER, 8 OZ. DIP CUP, 4 CELLS, LEAK RESISTANT.....	C13	SAB0512	12 OZ. BLACK SQUARE BOWL BASE.....	C11
1C90DP4CJ	13" CLEAR PLATTER, 8 OZ. DIP CUP, 4 CELLS W/ JUICE TRAP, LEAK RESISTANT.....	C13	SAB0516	16 OZ. BLACK SQUARE BOWL BASE.....	C11
1340DD4CVL	13" CLEAR PLATTER, 16 OZ. DIP CUP, 4 CELLS, VENTED LID.....	C13	SAB0724	24 OZ. BLACK SQUARE BOWL BASE.....	C11
1C11CLID	13" PLATTER LID, LEAK RESISTANT.....	C13	SAB0732	32 OZ. BLACK SQUARE BOWL BASE.....	C11
1C11DL20T	13" DOME LID 2" HIGH W/TAB.....	C13	SAB0948	48 OZ. BLACK SQUARE BOWL BASE.....	C11
1C11DLTSPK	13" DOME LID SPIKE & TAB TRIM.....	C13	SAB0964	64 OZ. BLACK SQUARE BOWL BASE.....	C11
13625	C11 OZ. COMBO SALAD BOWL - BLACK/CLEAR.....	C7	SAC0508	8 OZ. CLEAR SQUARE BOWL BASE.....	C11
13626	24 OZ. COMBO SALAD BOWL - BLACK/CLEAR.....	C7	SAC0512	12 OZ. CLEAR SQUARE BOWL BASE.....	C11
13630	C11 OZ. COMBO SALAD BOWL - CLEAR/CLEAR.....	C7	SAC0516	16 OZ. CLEAR SQUARE BOWL BASE.....	C11
136C7	24 OZ. COMBO SALAD BOWL - CLEAR/CLEAR.....	C7	SAC0724	24 OZ. CLEAR SQUARE BOWL BASE.....	C11
13PP20SLT	12" RND SWIRL TABBED LR DOME W/BLACK BASE, STD 8 OZ DELI CUP DIP HOLDER.....	C7, C13	SAC0732	32 OZ. CLEAR SQUARE BOWL BASE.....	C11
13X19DO390	4" OVAL DEEP FLUTED DOME W/BLACK SWIRL BASE.....	C7	SAC0948	48 OZ. CLEAR SQUARE BOWL BASE.....	C11
13X19DOCO50	4" OVAL DEEP FLUTED TABBED DOME W/BLACK SWIRL BASE.....	C13	SAC0964	64 OZ. CLEAR SQUARE BOWL BASE.....	C11
13VL	13" VENTED LID.....	C13	SACLD05	8, 12, 16 OZ. CLEAR DOME LID.....	C11
16D375DLT	16" ROUND DEEP FLUTED TABBED DOME W/BLACK LAZY SUSAN 6 CMPT BASE.....	C7	SACLD07	24, 32 OZ. CLEAR DOME LID.....	C11
16DC1C11DLT	16" ROUND DEEP FLUTED TABBED DOME W/BLACK LAZY SUSAN 6 CMPT BASE.....	C13	SACLD09	48, 64 OZ. CLEAR DOME LID.....	C11
16DF375DLT	16" ROUND DEEP FLUTED TABBED DOME W/BLACK FLAT BASE.....	C7	SACLF05	8, 12, 16 OZ. CLEAR FLAT LID.....	C11
16DFC1C11DLT	16" ROUND DEEP FLUTED TABBED DOME W/BLACK FLAT BASE.....	C13	SACLF07	24, 32 OZ. CLEAR FLAT LID.....	C11
18D375DLT	18" ROUND DEEP FLUTED TABBED DOME W/BLACK LAZY SUSAN 6 CMPT BASE.....	C7	SACLF09	48, 64 OZ. CLEAR FLAT LID.....	C11
18DC1C11DLT	18" ROUND DEEP FLUTED TABBED DOME W/BLACK LAZY SUSAN 6 CMPT BASE.....	C13	SACLI07T	7.C1C11" INSERT FOR SQUARE SALAD CONTAINERS.....	C11
18DF375DLT	18" ROUND DEEP FLUTED TABBED DOME W/BLACK FLAT BASE.....	C7	SACLI09T	9" INSERT FOR SQUARE SALAD CONTAINERS.....	C11
18DFC1C11DLT	18" ROUND DEEP FLUTED TABBED DOME W/BLACK FLAT BASE.....	C13	Y1120-45	FULL SIZE METAL STEAM TABLE COVER.....	C3
4412-10A	12" CATERWARE® DELUXE LAZY SUSAN.....	C5	Y112045DG	GOLD FOIL COVER FOR FULL STEAM TABLE PANS.....	C3
4416-10A	16" CATERWARE® DELUXE LAZY SUSAN.....	C5	Y6012XH	HALF SIZE STEAM TABLE PAN - SHALLOW.....	C3
4418-10A	18" CATERWARE® DELUXE LAZY SUSAN.....	C5	Y6050XH	FULL SIZE STEAM TABLE PAN.....	C3
4512-12A	12" CATERWARE® DELUXE FLAT TRAY.....	C5	Y6050XHEDK	FULL SIZE DEEP STEAM TABLE PAN.....	C3
4516-12A	16" CATERWARE® DELUXE FLAT TRAY.....	C5	Y6050XXH	FULL SIZE STEAM TABLE PAN.....	C3
4518-12A	18" CATERWARE® DELUXE FLAT TRAY.....	C5	Y6110XH	FULL SIZE STEAM TABLE.....	C3
6062XH	1/3 SIZE STEAM TABLE.....	C3	Y6112H	1/2 SIZE STEAM TABLE.....	C3
6174-55D	CATERBOWL® CONTAINER.....	C5	Y6112XH	1/2 SIZE STEAM TABLE.....	C3
6182-55D	CATERBOWL® JR CONTAINER.....	C5	Y6112XHE	1/2 SIZE STEAM TABLE - PROTECTIVE COATED INSIDE.....	C3
6C38XHY	LARGE CROWN OVAL ROASTER.....	C5	Y6120XH	FULL SIZE STEAM TABLE.....	C3
6C58XHY	LARGE CROWN RECTANGULAR ROASTER.....	C5	Y6132L	1/2 SIZE STEAM TABLE - DEEP.....	C3
6264XH	BULK FOOD STEAM TABLE.....	C3	Y6132H	1/2 SIZE STEAM TABLE.....	C3
6342-60	1/2 SIZE STEAM TABLE.....	C3	Y6132XH	1/2 SIZE STEAM TABLE.....	C3
671065EDK	42 OZ. SMALL BLACK/GOLD FOIL BASE.....	C3	Y6132XHE	1/2 SIZE STEAM TABLE - PROTECTIVE COATED INSIDE.....	C3
65172CJ	17 OZ. SQUARE CLEAR CONTAINER, 2 CELLS W/ JUICE TRAP.....	C13	Y6132XHEDK	DEEP FOIL 1/2 SIZE STEAM TABLE PAN.....	C3
65324C	32 OZ. SQUARE CLEAR CONTAINER, 4 COMPARTMENTS.....	C13	Y966516KWP	16" HEXQUISITE® BOWL W/DOME.....	C7
65324CFL	6" 32 OZ. SQUARE CLEAR CONTAINER, 4 CELLS W/FLAT LID.....	C13	Y670855EDK	SINGLE SERVE BLACK/GOLD BASE.....	C9
65D17DP3CJ	17 OZ. SQUARE DIAMOND CONTAINER, DIP CUP, 3 CELLS W/ JUICE TRAP.....	C13	YE11175BAL	24 COUNT EGG INSERT.....	C3
65D202CJ	20 OZ. DIAMOND PLATTER, 2 CELLS W/ JUICE TRAP.....	C13	YNLP12B	12" APET BLACK FLAT CATER TRAY BASE.....	C9
65LRL	6" SQUARE LEAK RESISTANT LID.....	C13	YNLP12B225R50	2.25" APET ROSEDOME™ W/12" LAZY SUSAN BLACK BASE-COMBO PACK.....	C9
9005K	9" X 2" CATERWARE® CATERMATE® GLOSS BLACK SERVING FORK.....	C7	YNLP12B2C110R	3.5" APET ROSEDOME™ W/12" BLACK BASE.....	C9
9006K	9" X 2" CATERWARE® CATERMATE® GLOSS BLACK SERVING SPOON.....	C7	YNLP12FB225R	2.25" APET ROSEDOME™ W/12" FLAT BLACK BASE-COMBO PACK.....	C9
9007K	7" CATERWARE® CATERMATE® BLACK TONGS.....	C7	YNLP12LBC110R3.5"	APET ROSEDOME™ W/12" LAZY SUSAN BLACK BASE-COMBO PACK.....	C9
92210KWP	25 OZ CATERWARE® CATERBOWL® BLACK SERVING BOWL W/DOME.....	C7	YNLP16B400R	4" APET ROSEDOME™ W/16" LAZY SUSAN BLACK BASE.....	C9
92220K	5 LB CATERWARE® CATERBOWL® BLACK SERVING BOWL.....	C7	YNLP16FB400R	4" APET ROSEDOME™ W/16" FLAT BLACK BASE-COMBO PACK.....	C9
92230K	10 LB CATERWARE® CATERBOWL® BLACK SERVING BOWL.....	C7	YNLP18B450R	4.5" APET ROSEDOME™ W/18" FLAT BLACK BASE-COMBO PACK.....	C9
966012KWP	12" HEXQUISITE® TRAY W/DOME.....	C7	YPP05C7	10.25" 4 CMPT. PRODUCE PLATTER W/DIP CUP & LID.....	C13
966016KWP	16" HEXQUISITE® TRAY W/DOME.....	C7	YPP25	13" 4 CMPT. PRODUCE PLATTER W/DIP CUP.....	C13
966018KWP	18" HEXQUISITE® TRAY W/DOME.....	C7	YPP25C9	13" 4 CMPT. PRODUCE PLATTER W/DIP CUP & LID.....	C13
966512KWP	12" HEXQUISITE® BOWL W/DOME.....	C7	YPPPC5C9	13" 4 CMPT. PRODUCE PLATTER W/DIP CUP & LID.....	C13
9812K	12" BLACK PLASTIC SMARTLOCK® CATERWARE® TRAY.....	C9, C11			
9812KCA9WP	12" BLACK PLASTIC SMARTLOCK® CATERWARE® TRAY W/APET DOME LID.....	C9, C11			
9812KWP	12" BLACK PLASTIC SMARTLOCK® CATERWARE® TRAY W/DOME.....	C9			
9816K	16" BLACK PLASTIC SMARTLOCK® CATERWARE® TRAY.....	C9, C11			
9816KCA9WP	16" BLACK PLASTIC SMARTLOCK® CATERWARE® TRAY W/APET DOME LID.....	C9, C11			
9816KWP	16" BLACK PLASTIC SMARTLOCK® CATERWARE® TRAY W/DOME.....	C9			
9818K	18" BLACK PLASTIC SMARTLOCK® CATERWARE® TRAY.....	C9, C11			
9818KCA9WP	18" BLACK PLASTIC SMARTLOCK® CATERWARE® TRAY W/APET DOME LID.....	C9, C11			
9818KWP	18" BLACK PLASTIC SMARTLOCK® CATERWARE® TRAY W/DOME.....	C9			
9912K	12" BLACK PLASTIC SMARTLOCK® CATERWARE® LAZY SUSAN TRAY.....	C9, C11			
9912KCA9WP	12" BLACK PLASTIC SMARTLOCK® CATERWARE® LAZY SUSAN TRAY W/APET DOME LID.....	C9, C11			
9912KWP	12" BLACK PLASTIC SMARTLOCK® CATERWARE® LAZY SUSAN TRAY W/DOME.....	C9			
9916K	16" BLACK PLASTIC SMARTLOCK® CATERWARE® LAZY SUSAN TRAY.....	C9, C11			
9916KCA9WP	16" BLACK PLASTIC SMARTLOCK® CATERWARE® LAZY SUSAN TRAY W/APET DOME LID.....	C9, C11			
9916KWP	16" BLACK PLASTIC SMARTLOCK® CATERWARE® LAZY SUSAN TRAY W/DOME.....	C9			
9918K	18" BLACK PLASTIC SMARTLOCK® CATERWARE® LAZY SUSAN TRAY.....	C9, C11			
9918KCA9WP	18" BLACK PLASTIC SMARTLOCK® CATERWARE® LAZY SUSAN TRAY W/APET DOME LID.....	C9, C11			
9918KWP	18" BLACK PLASTIC SMARTLOCK® CATERWARE® LAZY SUSAN TRAY W/DOME.....	C9			
CA9-9812	12" DIA CLEAR CATERWARE® DOME LID - APET.....	C11			
CA9-9816	16" DIA CLEAR CATERWARE® DOME LID - APET.....	C11			
CA9-9818	18" DIA CLEAR CATERWARE® DOME LID - APET.....	C11			
NLP187C325R	3.25" APET ROSEDOME™ W/18" 7-CMPT LAZY SUSAN BASE-COMBO PACK.....	C9			
NLP18FB450R	4.5" APET ROSEDOME™ W/18" FLAT BLACK BASE-COMBO PACK.....	C9			
P9C110	PLASTIC DOME FOR BULK FOOD PANS.....	C3			
P4412	12" CATERWARE® CRYSTAL CUT™ DOME.....	C5			



## Aluminum Classic Carry-Out® Packaging

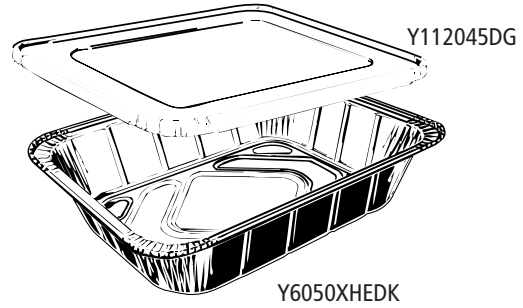
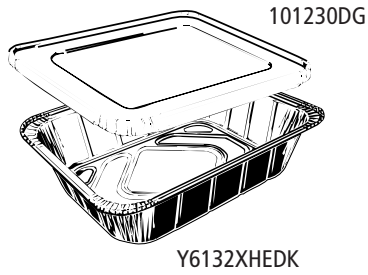

## Aluminum Steam Tables — Full Size

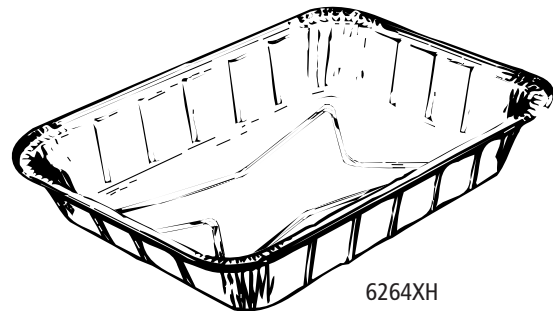
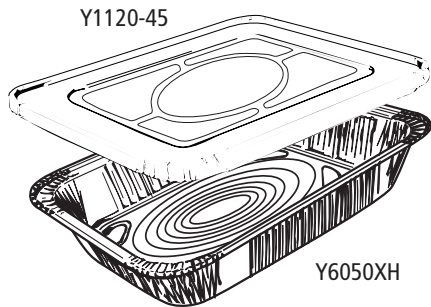

## Aluminum Steam Tables — Half Size

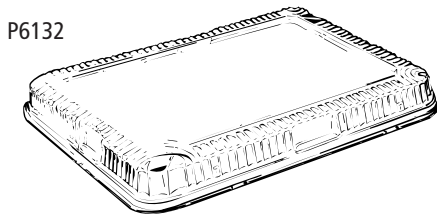

1012-30, 1012-30E

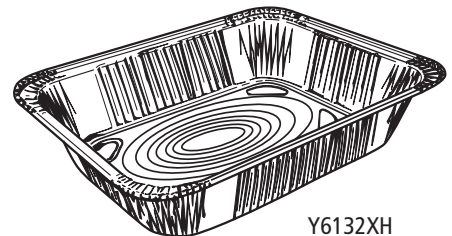
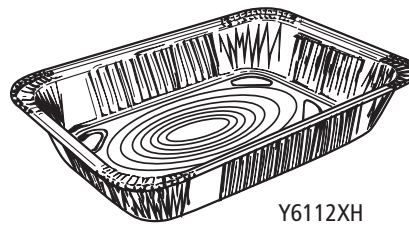
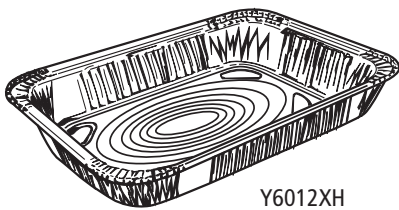
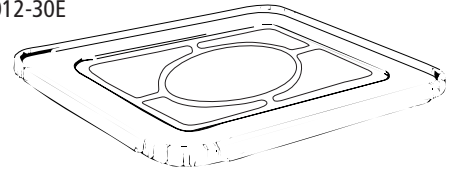

## Aluminum Steam Tables — Third Size

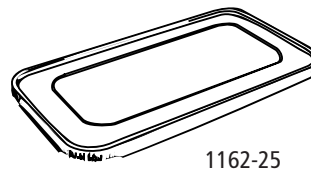
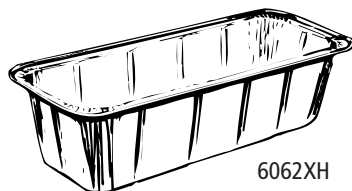

### Aluminum Classic Carry-Out® Packaging

Product Number	Description	Capacity (fl. oz.)	Top Out	Dimensions (in inches)		Vert. Depth	Case Cube	Case Weight	Case Pack	Cases/ Unit Load
				Top In	Bottom					
Y670855EDK	20 oz. Single Serve Blk/Gold Foil Base	20.0	8 3/16 x 6 3/16	7 1/2 x 5 1/2	7 3/16 x 5 3/16	1 1/4	1.05	11.10	250	54
671065EDK	42 oz. Small Black/Gold Foil Base	42.0	9 3/4 x 7 3/4	9 x 7	8 9/16 x 6 9/16	1 3/4	1.88	19.41	250	
Y6132XHEDK	Blk./Gold Deep Foil Half Steam Table Pan	120.0	12 3/4 x 10 3/8	11 3/4 x 9 3/8	10 1/4 x 7 7/8	2 9/16	2.01	11.39	100	32
101230DG	Gold Foil Cover for Half Steam Table Pan	--	12 13/16 x 10 7/16	12 5/16 x 9 15/16	10 1/16 x 7 23/32	5/8	0.92	6.09	100	
Y6050XHEDK	Blk./Gold Deep Foil Full Steam Table Pan	346.0	20 3/4 x 12 13/16	19 9/16 x 11 5/8	18 5/16 x 10	3 3/8	1.98	14.19	40	32
Y112045DG	Gold Foil Cover for Full Steam Table Pan	--	20 13/16 x 12 7/8	20 5/16 x 12 3/8	17 13/32 x 9 15/32	5/8	1.39	11.52	80	30

Classic Carry-Out® containers are microwaveable under the proper conditions: the container must not touch the side walls of the microwave; it must not be covered with aluminum foil; it must be at least 2/3 full of food. Do not use in ovens manufactured pre-1980.

### Aluminum Steam Tables — Full Size

Product Number	Description	Capacity (fl. oz.)	Top Out	Dimensions (in inches)		Vert. Depth	Case Cube	Case Weight	Rim Style	Case Pack	Cases/ Unit Load
				Top In	Bottom						
Y6110XH	Full Size Pan - Shallow	174.7	20 3/4 x 12 13/16	19 9/16 x 11 5/8	18 5/8 x 10 11/16	1 11/16	1.60	10.95	F.C.	40	40
Y6120XH	Full Size Pan - Medium	228.0	20 3/4 x 12 13/16	19 9/16 x 11 5/8	18 5/16 x 10	2 3/16	1.82	11.79	F.C.	40	32
Y6050XH	Full Size Pan - Deep	346.0	20 3/4 x 12 13/16	19 9/16 x 11 5/8	17 19/32 x 9 21/32	3 3/8	1.81	13.30	F.C.	40	32
Y6050XXH	Full Size Pan - Deep	346.0	20 3/4 x 12 13/16	19 9/16 x 11 5/8	17 19/32 x 9 21/32	3 3/8	1.94	15.24	F.C.	40	24
Y1120-45	Metal Cover for 6050, 6120 & 6110	--	20 13/16 x 12 7/8	20 5/16 x 12 3/8	17 13/32 x 9 15/32	5/8	1.39	11.52	I.V.C.F.	80	30
6264XH*	Bulk Food Pan	173.0	14 1/2 x 10 5/8	13 1/2 x 9 5/8	12 5/16 x 8 7/16	2 15/16	2.39	14.53	F.C.	100	

### Aluminum Steam Tables — Half Size

Product Number	Description	Capacity (fl. oz.)	Top Out	Dimensions (in inches)		Vert. Depth	Case Cube	Case Weight	Rim Style	Case Pack	Cases/ Unit Load
				Top In	Bottom						
Y6012XH	Half Size Pan - Shallow	79.5	12 3/4 x 10 3/8	11 3/4 x 9 3/8	10 13/16 x 8 7/16	1 11/16	1.95	9.18	V.C.	100	32
Y6112H	Half Size Pan - Medium	104.0	12 3/4 x 10 3/8	11 3/4 x 9 3/8	10 1/2 x 8 1/8	2 3/16	2.01	9.35	V.C.	100	32
Y6112XH	Half Size Pan - Medium/Heavy	104.0	12 3/4 x 10 3/8	11 3/4 x 9 3/8	10 1/2 x 8 1/8	2 3/16	2.01	10.04	V.C.	100	32
Y6112XHE	Half Size Pan - Medium Protective Coated Inside	104.0	12 3/4 x 10 3/8	11 3/4 x 9 3/8	10 1/2 x 8 1/8	2 3/16	2.01	10.82	V.C.	100	32
Y6132L	Half Size Pan - Deep	120.0	12 3/4 x 10 3/8	11 3/4 x 9 3/8	10 1/4 x 7 7/8	2 9/16	2.01	9.51	F.C.	100	32
Y6132H	Half Size Pan - Deep	120.0	12 3/4 x 10 3/8	11 3/4 x 9 3/8	10 1/4 x 7 7/8	2 9/16	2.01	10.47	F.C.	100	32
Y6132XH	Half Size Pan - Deep	120.0	12 3/4 x 10 3/8	11 3/4 x 9 3/8	10 1/4 x 7 7/8	2 9/16	2.01	10.95	F.C.	100	32
Y6132XHE	Half Size Pan - Deep Protective Coated Inside	120.0	12 3/4 x 10 3/8	11 3/4 x 9 3/8	10 1/4 x 7 7/8	2 9/16	2.01	11.29	F.C.	100	32
6342-60	Half Size Pan - Extra Deep	187.0	12 3/4 x 10 3/8	11 3/4 x 9 3/8	9 1/2 x 7 1/8	4 3/16	2.94	20.16	R.F.C.	100	
P6132	Clear Cover for Half Size Pans	--	13 1/4 x 10 7/8	12 3/4 x 10 7/16	11 3/16 x 8 3/4	1 1/4	3.16	10.00	--	100	24
1012-30	Metal Cover Half Size for 6112, 6132 & 6342	--	12 13/16 x 10 7/16	12 5/16 x 9 15/16	10 1/16 x 7 23/32	5/8	0.92	5.76	I.V.C.	100	
1012-30E	Metal Cover Coated for 6112, 6132 & 6342	--	12 13/16 x 10 7/16	12 5/16 x 9 15/16	10 1/16 x 7 23/32	5/8	0.92	5.84	I.V.C.	100	

### Aluminum Steam Tables — Third Size

Product Number	Description	Capacity (fl. oz.)	Top Out	Dimensions (in inches)		Vert. Depth	Case Cube	Case Weight	Rim Style	Case Pack
				Top In	Bottom					
6062XH	Third Size Pan - Deep	93.0	12 5/8 x 6 1/2	11 3/4 x 5 5/8	10 3/8 x 5 1/4	3 3/16	1.46	12.14	F.C.	150
1162-25	Metal Cover for 6062	--	12 11/16 x 6 3/16	12 5/16 x 6 3/16	10 3/16 x 4 1/16	1/2	0.66	4.55	I.V.C.	150

## Aluminum Rack 'N' Roast® Roasters



## Caterware® Caterbowl® Shell Bowls

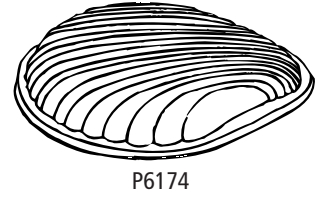
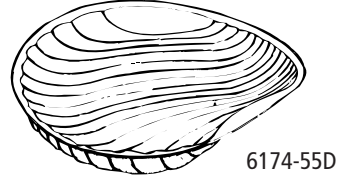
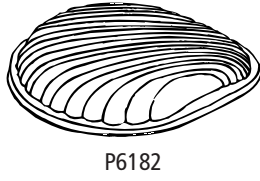
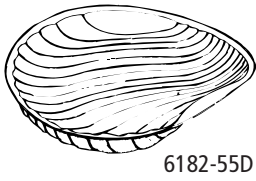

## Caterware Deluxe Embossed Aluminum Trays

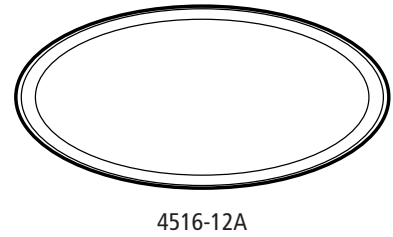
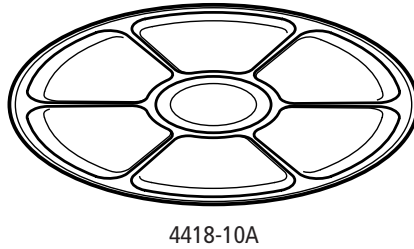
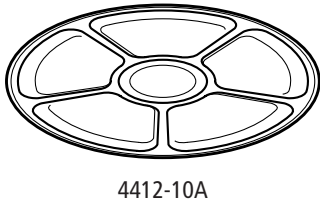

## Caterware Clear Plastic Domes—Fit Aluminum Trays

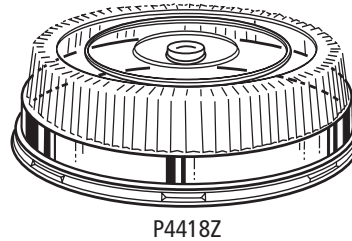
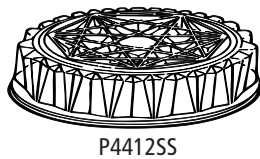
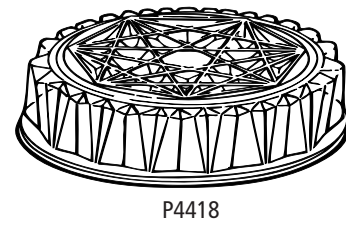
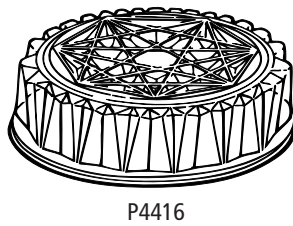
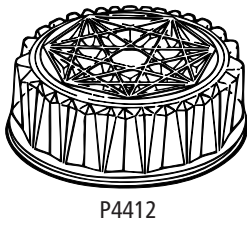

### Aluminum Rack 'N' Roast® Roasters

Product Number	Description	Capacity (fl. oz.)	Top Out	Dimensions (in inches)			Vert. Depth	Case Cube	Case Weight	Rim Style	Case Pack	Cases/ Unit Load
				Top In	Bottom							
6278XHY	Large Crown Oval Roaster	256.3	18 ¼ x 14	16 15/16 x 12 11/16	15 1/8 x 10 7/8	3 ¼	2.77	12.21	F.C.	50	18	
6298XHY	Large Crown Rectangular Roaster	202.8	17 ½ x 13 1/16	16 1/16 x 11 11/16	14 ¼ x 9 7/8	2 7/8	2.49	11.85	F.C.	50	18	

### Caterware® Caterbowl® Shell Bowls

Product Number	Description	Cube	Case Weight	Case Pack	Cases/ Unit Load
6182-55D	Caterbowl® Jr. Small Shell Bowl 12 x 10 x 2 ½" - Approx. 73 fl. oz. Fits P6182 Dome.	0.73	2.93	25	
P6174	Large Clear Shell Shaped Dome. 1 ½" Deep. Fits 6174 Bowl.	0.65	3.00	25	72
P6182	Small Clear Shell Shaped Dome 1 ½" Deep. Fits 6182 Bowl.	0.65	2.00	25	150

### Caterware Deluxe Embossed Aluminum Trays

Product Number	Description	Cube	Case Weight	Case Pack
4416-10A	16" dia. Lazy Susan Five Compartment Tray. Fits P4416, P4416Z Domes.	1.59	13.13	50
4418-10A	18" dia. Lazy Susan Six Compartment Tray. Fits P4418, P4418Z Domes.	2.05	17.94	50
4512-12A	12" dia. Flat Tray. Fits P4412, P4412S, P4412SS Domes.	0.93	8.54	50
4516-12A	16" dia. Flat Tray. Fits P4416, P4416Z Domes.	1.67	14.79	50
4518-12A	18" dia. Flat Tray. Fits P4418, P4418Z Domes.	2.00	17.92	50

### Caterware Clear Plastic Domes—Fit Aluminum Trays

Product Number	Description	Cube	Case Weight	Sleeve	Case Pack	Cases/ Unit Load
P4412SS	12" dia. x 1 ¼" Super Shallow Clear Plastic Crystal Cut™ Dome Fits 4412, 4512.	1.95	4.71	1/50	50	24
P4416	16" dia. x 2 ½" Deep Clear Plastic Crystal Cut™ Dome. Fits 4416, 4516.	3.30	8.10	1/50	50	18
P4418	18" dia. x 2 ½" Deep Clear Plastic Crystal Cut™ Dome. Fits 4418, 4518.	4.18	10.35	1/50	50	8
P4418Z	18" dia. x 3 ½" Deep Clear Plastic Original Style Dome. Fits 4418, 4518.	4.22	11.06	1/50	50	12

CATERWARE CRYSTAL CUT Domes produced under one or more of the following patents: 4,863,058; 4,874,083

**Caterware® Caterbowl® Disposable Serving Bowls**

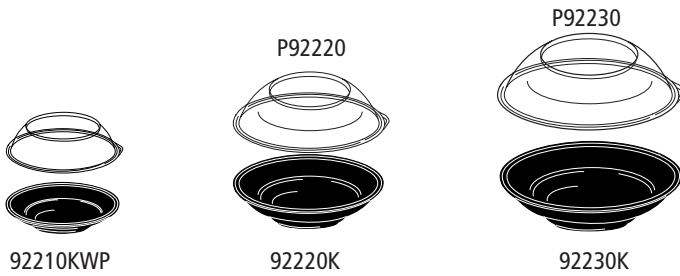

**Reynolds® CaterTime® Lock-Fresh™ Salad Bowls - PETE**

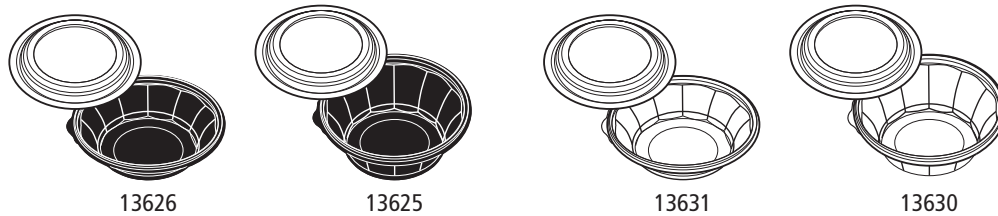

**Caterware® Catermate® Serving Utensils**

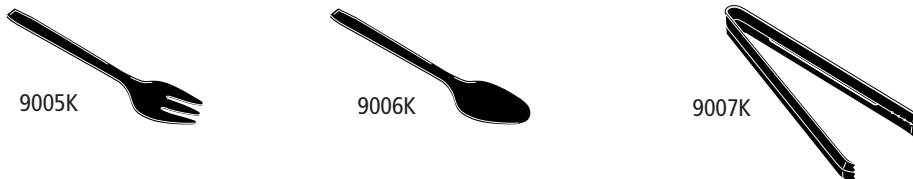

**Caterware® Hexquisite® Catering System**

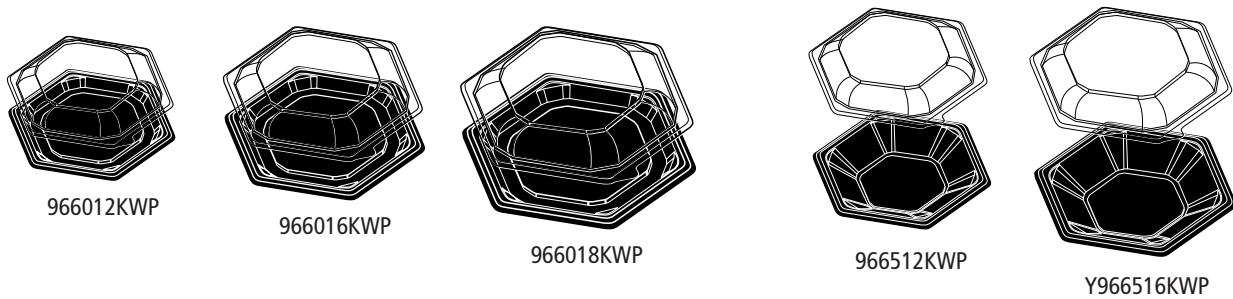

**Round Fluted Entertainware™ Party Platters – Combos**

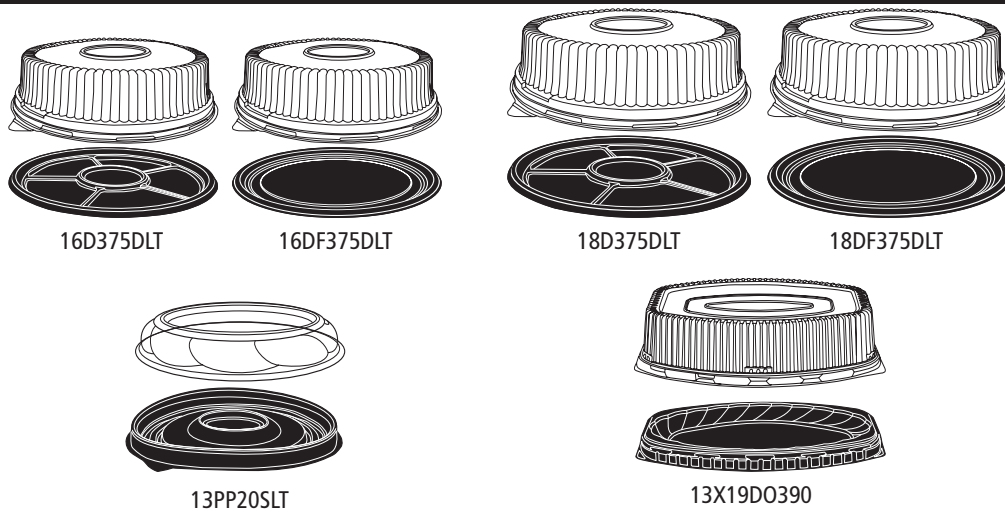



### Caterware® Caterbowl® Disposable Serving Bowls

Product Number	Description	Capacity (lbs.)	Dimensions (in inches)			Vert. Depth	Case		Case Sleeve	Case Pack	Cases/ Unit Load
			Top Out	Top In	Bottom		Cube	Weight			
92210KWP	9" Black Bowl w/Dome	25 oz.	9 9 21/64	8 13/32 7 7/8	5 5 25/32	1 1/2 1 3/8	4.43	20.88	5/40	200	12
92220K	Black Bowl	5 lb./80 oz.	12 1/8	11 13/32	6 3/4	2 1/4	0.74	4.85	1/25	25	72
P92220	Clear Plastic Dome	--	12 9/16	10 3/4	7 11/16	2 3/8	1.04	3.56	1/25	25	45
92230K	Black Bowl	10 lb./160 oz.	14 3/8	13 1/2	6 3/4	2 23/32	1.25	7.64	1/25	25	45
P92230	Clear Plastic Dome	--	14 13/16	12 27/32	9	2 3/8	1.42	4.65	1/25	25	30

### Reynolds® CaterTime® Lock-Fresh™ Salad Bowls - PETE

Product Number	Description	Color	Dimensions (in inches)			Vert. Depth	Case		Case Pack	Cases/ Unit Load
			Top Out	Top In	Bottom		Cube	Weight		
13626	24 oz. Combo Salad Bowl	Black/Clear	9	8	5 1/2	2	3.45	11.70	100	30
13625	35 oz. Combo Salad Bowl	Black/Clear	9	8	5 1/2	2 3/4	3.45	11.70	100	30
13631	24 oz. Combo Salad Bowl	Clear/Clear	9	8	5 1/2	2	3.45	11.70	100	30
13630	35 oz. Combo Salad Bowl	Clear/Clear	9	8	5 1/2	2	3.45	11.70	100	30

### Caterware® Catermate® Serving Utensils

Product Number	Description	Case Cube	Case Weight	Case Sleeve	Case Pack	Cases/ Unit Load
9006K	9" x 2" Gloss Black Serving Spoon	0.32	3.46	1/100	100	120
9007K	9" Black Serving Tongs	0.80	8.50	1/100	100	60

### Caterware® Hexquisite® Catering System

Product Number	Description	Capacity (lbs.)	Case Cube	Case Weight	Case Sleeve	Case Pack	Cases/ Unit Load
966016KWP	16" Black Tray w/Dome	--	3.22	15.31	1/25 ea.	25 ea.	13
966018KWP	18" Black Tray w/Dome	--	3.86	19.84	1/25 ea.	25 ea.	12
966512KWP	5lb. (12") Bowl w/Dome	5 lb./80 oz.	2.49	11.12	1/25 ea.	25 ea.	18
Y966516KWP	10lb. (16") Bowl w/Dome	10 lb./160 oz.	3.00	15.52	1/25 ea.	25 ea.	18

### Round Fluted Entertainware™ Party Platters – Combos

Product Number	Description	Dimensions (in inches)	Case		Case Pack
			Cube	Weight	
<b>Round Fluted Party Platters</b>					
16D375DLT	16" Round 3 3/4" Deep Fluted Tabbed Dome w/Black Lazy Susan 6-Cmpt. Base	16 1/2 x 3 3/4	2.60	12.00	25 Combo
16DF375DLT	16" Round 3 3/4" Deep Fluted Tabbed Dome w/Black Flat Base	16 1/2 x 3 3/4	2.60	12.00	25 Combo
18D375DLT	18" Round 3 3/4" Deep Fluted Tabbed Dome w/Black Lazy Susan 6-Cmpt. Base	18 1/2 x 3 3/4	3.30	15.00	25 Combo
18DF375DLT	18" Round 3 3/4" Deep Fluted Tabbed Dome w/Black Flat Base	18 1/2 x 3 3/4	3.30	17.00	25 Combo
<b>Round Swirl Party Platter</b>					
13PP20SLT	12" Round 2" Deep Swirl Tabbed Leak Resistant Dome w/Black Base w/Standard 8 oz. Deli Cup Dip Holder	12 4/7 x 2	4.00	15.00	50 Combo
<b>Oval Party Platter</b>					
13X19D0390	Oval 4" Deep Fluted Dome w/Black Swirl Base	19 x 12 3/5 x 3 9/10	4.50	17.00	35 Combo

SmartLock® Caterware® Black Plastic Trays

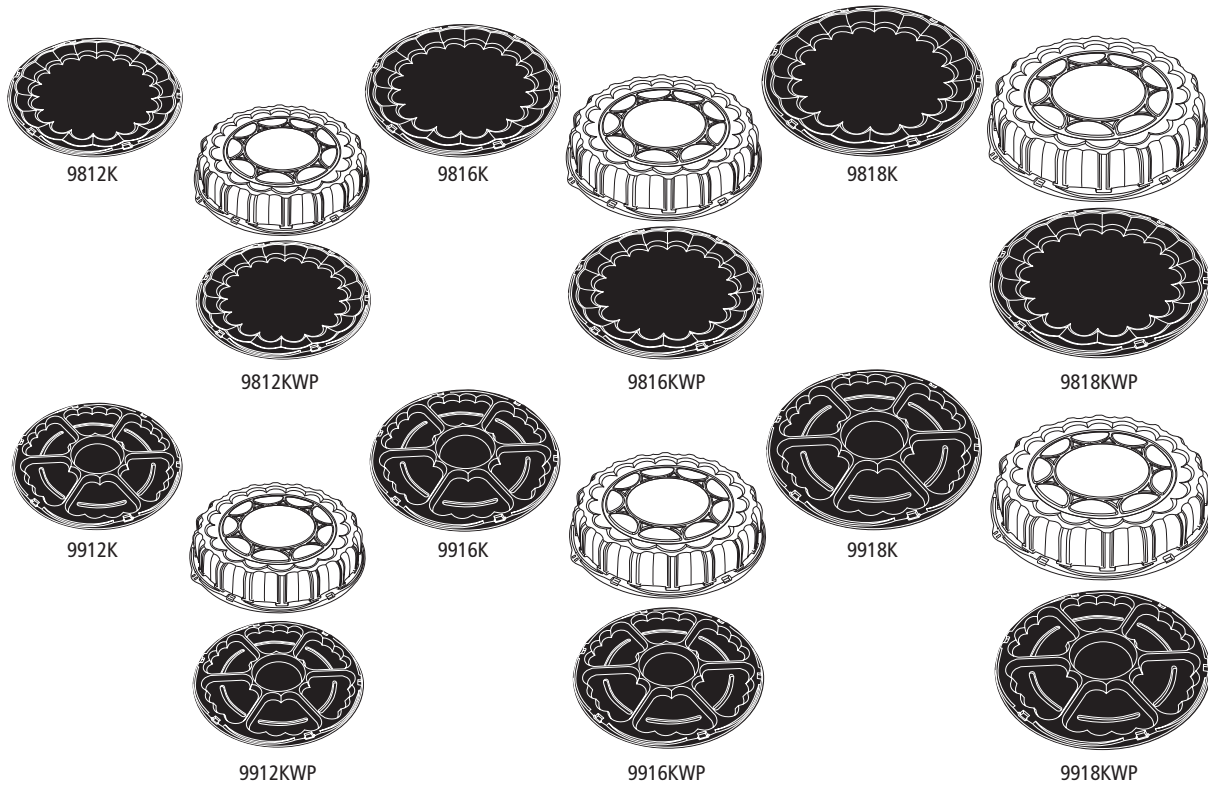

APET SmartLock® Caterware® Domes & HIPS Trays

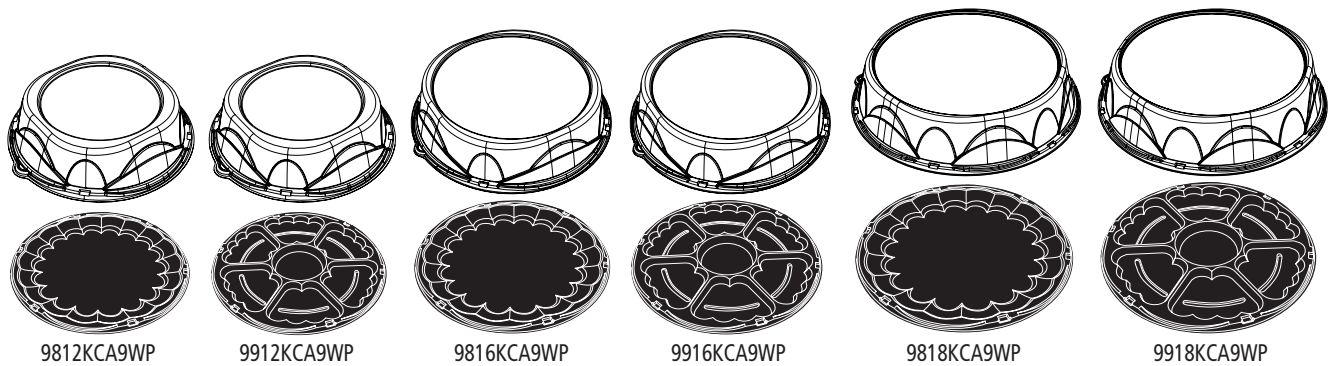

APET RoseDome™ Caterware®

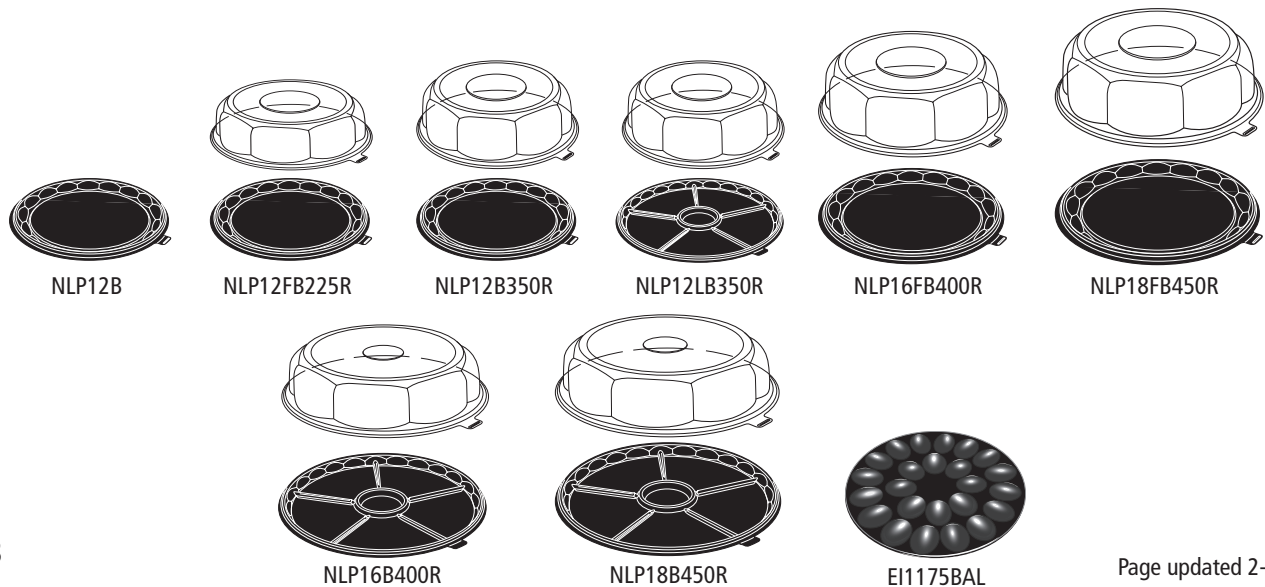

## SmartLock® Caterware® Black Plastic Trays

Product Number	Description	Case Cube	Case Weight	Sleeve	Case Pack	
<b>Scallop Rim Flat Trays</b>						
9812K	12" dia. Black Plastic SmartLock® Tray. Fits P9812	1.10	9.92	1/50	50	
9816K	16" dia. Black Plastic SmartLock® Tray. Fits P9816	1.72	16.75	1/50	50	
9818K	18" dia. Black Plastic SmartLock® Tray. Fits P9818	2.28	20.92	1/50	50	
9812KWP	12" dia. Black Plastic SmartLock® Tray w/Dome. (P9812)	1.37	8.69	1/25 ea.	25 ea.	
9816KWP	16" dia. Black Plastic SmartLock® Tray w/Dome. (P9816)	2.33	13.39	1/25 ea.	25 ea.	
9818KWP	18" dia. Black Plastic SmartLock® Tray w/Dome. (P9818)	2.80	16.73	1/25 ea.	25 ea.	
<b>Lazy Susan Trays</b>						
9912K	12" dia. Black Plastic SmartLock® Lazy Susan 6 Compartment Tray. Fits P9812.	1.13	9.69	1/50	50	
9916K	16" dia. Black Plastic SmartLock® Lazy Susan 6 Compartment Tray. Fits P9816.	1.59	14.77	1/50	50	
9918K	18" dia. Black Plastic SmartLock® Lazy Susan 6 Compartment Tray. Fits P9818.	2.25	20.49	1/50	50	
9912KWP	12" dia. Black Plastic SmartLock® Lazy Susan 6 Compartment Tray w/Dome. (P9812)	1.39	8.23	1/25 ea.	25 ea.	
9916KWP	16" dia. Black Plastic SmartLock® Lazy Susan 6 Compartment Tray w/Dome. (P9816)	2.35	12.33	1/25 ea.	25 ea.	
9918KWP	18" dia. Black Plastic SmartLock® Lazy Susan 6 Compartment Tray w/Dome. (P9818)	2.91	16.72	1/25 ea.	25 ea.	
<b>Caterware® Clear Plastic Domes</b>						
Product Number	Description	Dome Height (in inches)	Case Cube	Case Weight	Sleeve	Case Pack
P9812	12" dia. Clear Plastic Dome Lid. Fits 9812K, 9812KWP, 9912K, 9912KWP.	3 1/2	1.45	5.97	1/50	50
P9816	16" dia. Clear Plastic Dome Lid. Fits 9816K, 9816KWP, 9916K, 9916KWP.	3 1/2	2.00	10.76	1/50	50
P9818	18" dia. Clear Plastic Dome Lid. Fits 9818K, 9818KWP, 9918K, 9918KWP.	4.0	2.37	12.01	1/50	50

## APET SmartLock® Caterware® Domes & HIPS Trays

Product Number	Description	Base Depth	Dome Depth	Case Cube	Case Weight	Sleeve	Case Pack	Cases/ Unit Load
<b>Combo Packs</b>								
9812KCA9WP	12" dia. Black Plastic SmartLock® Flat Tray w/APET Dome Lid (CA9-9812)	15/16"	3"	1.34	9.52	1/25	25	36
9816KCA9WP	16" dia. Black Plastic SmartLock® Flat Tray w/APET Dome Lid (CA9-9816)	15/16"	3.5"	2.30	17.33	1/25	25	24
9818KCA9WP	18" dia. Black Plastic SmartLock® Flat Tray w/APET Dome Lid (CA9-9818)	15/16"	4"	2.76	22.39	1/25	25	16
9912KCA9WP	12" dia. Black Plastic SmartLock® Lazy Susan 6-Cmpt. Tray w/APET Dome Lid (CA9-9812)	1 7/32"	3"	1.37	9.15	1/25	25	36
9916KCA9WP	16" dia. Black Plastic SmartLock® Lazy Susan 6-Cmpt. Tray w/APET Dome Lid (CA9-9816)	1 7/32"	3.5"	2.32	17.33	1/25	25	16
9918KCA9WP	18" dia. Black Plastic SmartLock® Lazy Susan 6-Cmpt. Tray w/APET Dome Lid (CA9-9818)	1 13/32"	4"	2.87	22.38	1/25	25	16

## APET RoseDome™ Caterware®

Product Number	Description	Diameter	Case Pack	Case Weight	Case Cube
YNLP12B	12" Black Flat Cater Tray Base	12"	50	10.08	1.32
YNLP12FB225R	2.25" RoseDome™ with 12" Flat Black Base - Combo Pack	12"	25	9.58	1.83
YNLP12B225R50	2.25" RoseDome™ with 12" Lazy Susan Black Base - Combo Pack	12"	50	17.05	3.05
YNLP12B350R	3.5" RoseDome™ with 12" Flat Black Base - Combo Pack	12"	25	9.83	1.86
YNLP12LB350R	3.5" RoseDome™ with 12" Lazy Susan Black Base - Combo Pack	12"	25	10.51	1.83
YNLP16FB400R	4" RoseDome™ with 16" Flat Black Base - Combo Pack	16"	25	18.07	2.92
YNLP16B400R	4" RoseDome™ with 16" Lazy Susan Black Base - Combo Pack	16"	25	16.07	2.97
NLP187C325R	3.25" RoseDome™ with 18" 7 Compartment Lazy Susan Base - Combo Pack	18"	25	33.48	4.13
YNLP18FB450R	4.5" RoseDome™ with 18" Flat Black Base - Combo Pack	18"	25	22.68	4.07
NLP18B450R	4.5" RoseDome™ with 18" Lazy Susan Black Base - Combo Pack	18"	25	21.15	4.13
<b>Caterware® Egg Insert</b>					
YEI-1175BAL	24 Count Black Plastic Egg Insert Tray. (Fits all 12" Caterware® Trays)	12"	50	5.21	0.34

**APET SmartLock® Caterware® Domes & HIPS Trays**

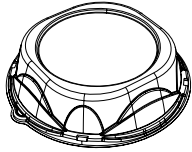

CA9-9812

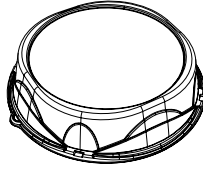

CA9-9816

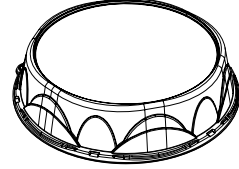

CA9-9818



9812K



9912K

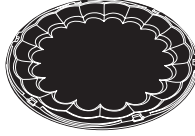

9816K



9916K

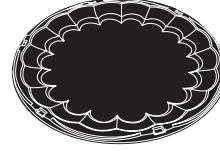

9818K



9918K

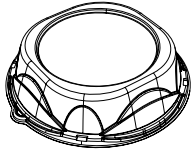

9812KCA9WP

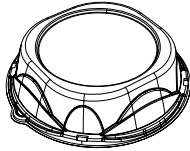

9912KCA9WP

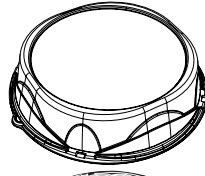

9816KCA9WP

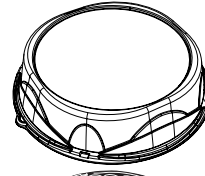

9916KCA9WP

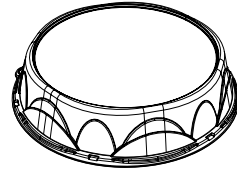

9818KCA9WP

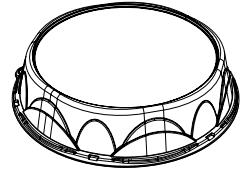

9918KCA9WP



9812KCA9WP



9912KCA9WP



9816KCA9WP



9916KCA9WP



9818KCA9WP



9918KCA9WP

**APET Square Salad Containers**

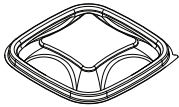

SACLD05

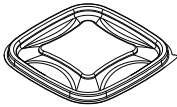

SACLF05

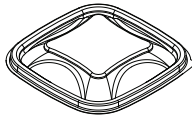

SACLD07

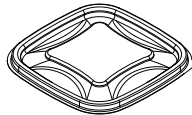

SACLF07

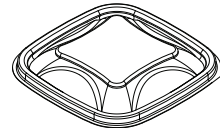

SACLD09

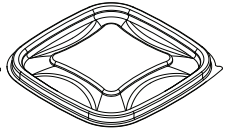

SACLF09

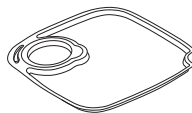

SACLI07T

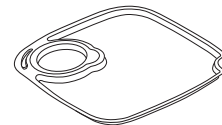

SACLI09T



SAB0508



SAB0512



SAB0516



SAB0724



SAB0732

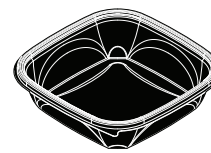

SAB0948

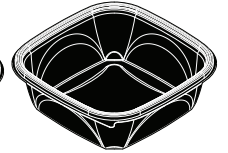

SAB0964

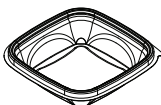

SAC0508

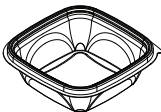

SAC0512

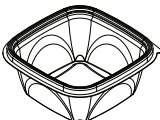

SAC0516

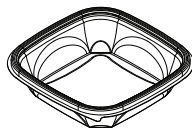

SAC0724

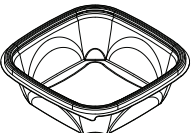

SAC0732

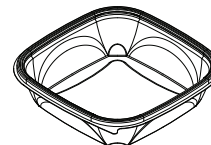

SAC0948

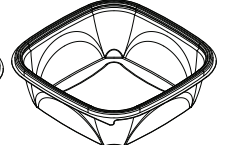

SAC0964

## APET SmartLock® Caterware® Domes & HIPS Trays

Product Number	Description	Dome Height	Case Cube	Case Weight	Sleeve	Case Pack	Cases/ Unit Load
<b>Domes</b>							
CA9-9812	12" dia. Clear APET Caterware® Dome Lid. Fits 9812K, 9912K	3"	1.15	9.75	50	50	
CA9-9816	16" dia. Clear APET Caterware® Dome Lid. Fits 9816K, 9916K	3.5"	2.10	17.64	50	50	
CA9-9818	18" dia. Clear APET Caterware® Dome Lid. Fits 9818K, 9918K	4"	2.64	22.39	50	50	
<b>Bases</b>							
		Base Depth					
9812K	12" dia. Black Plastic SmartLock® Flat Tray	15/16"	1.10	9.92	50	50	45
9816K	16" dia. Black Plastic SmartLock® Flat Tray	15/16"	1.72	16.75	50	50	30
9818K	18" dia. Black Plastic SmartLock® Flat Tray	15/16"	2.28	20.92	50	50	20
9912K	12" dia. Black Plastic SmartLock® Lazy Susan 6-Cmpt. Tray	1 7/32"	1.13	9.69	50	50	45
9916K	16" dia. Black Plastic SmartLock® Lazy Susan 6-Cmpt. Tray	1 7/32"	1.59	14.77	50	50	16
9918K	18" dia. Black Plastic SmartLock® Lazy Susan 6-Cmpt. Tray	1 13/32"	2.25	20.49	50	50	20
<b>Combo Packs</b>							
		Base Depth					
9812KCA9WP	12" dia. Black Plastic SmartLock® Flat Tray w/APET Dome Lid (CA9-9812)	15/16"	1.34	9.52	1/25	25	36
9816KCA9WP	16" dia. Black Plastic SmartLock® Flat Tray w/APET Dome Lid (CA9-9816)	15/16"	2.30	17.33	1/25	25	24
9818KCA9WP	18" dia. Black Plastic SmartLock® Flat Tray w/APET Dome Lid (CA9-9818)	15/16"	2.76	22.39	1/25	25	16
9912KCA9WP	12" dia. Black Plastic SmartLock® Lazy Susan 6-Cmpt. Tray w/APET Dome Lid (CA9-9812)	1 7/32"	1.37	9.15	1/25	25	36
9916KCA9WP	16" dia. Black Plastic SmartLock® Lazy Susan 6-Cmpt. Tray w/APET Dome Lid (CA9-9816)	1 7/32"	2.32	17.33	1/25	25	16
9918KCA9WP	18" dia. Black Plastic SmartLock® Lazy Susan 6-Cmpt. Tray w/APET Dome Lid (CA9-9818)	1 13/32"	2.87	22.38	1/25	25	16

## APET Square Salad Containers

Product Number	Description	Dimension (in inches)	Bowl Depth (in inches)	Case Cube	Approx. Wt.	Packing Sleeve	Case
SAB0508	8 oz Black Square Bowl Base	5 x 5	1.0	3.08	14.93	8/63	504
SAB0512	12 oz Black Square Bowl Base	5 x 5	1.45	3.08	16.04	8/63	504
SAB0516	16 oz Black Square Bowl Base	5 x 5	2.0	3.08	22.71	8/63	504
SAC0508	8 oz Clear Square Bowl Base	5 x 5	1.0	3.08	14.93	8/63	504
SAC0512	12 oz Clear Square Bowl Base	5 x 5	1.45	3.08	16.04	8/63	504
SAC0516	16 oz Clear Square Bowl Base	5 x 5	2.0	3.08	22.71	8/63	504
SAB0724	24 oz Black Square Bowl Base	7.375 x 7.375	1.52	3.24	18.41	4/75	300
SAB0732	32 oz Black Square Bowl Base	7.375 x 7.375	2.0	3.24	19.07	4/75	300
SAC0724	24 oz Clear Square Bowl Base	7.375 x 7.375	1.52	3.24	18.41	4/75	300
SAC0732	32 oz Clear Square Bowl Base	7.375 x 7.375	2.0	3.24	19.07	4/75	300
SAB0948	48 oz Black Square Bowl Base	9 x 9	2.0	2.54	15.43	2/75	150
SAB0964	64 oz Black Square Bowl Base	9 x 9	2.6	2.54	17.74	2/75	150
SAC0948	48 oz Clear Square Bowl Base	9 x 9	2.0	2.54	15.43	2/75	150
SAC0964	64 oz Clear Square Bowl Base	9 x 9	2.6	2.54	17.74	2/75	150
SACLD05	8-12-16 oz Clear Dome Lid	5 x 5	.68	2.22	12.39	6/84	504
SACLF05	8-12-16 oz Clear Flat Lid	5 x 5	.26	2.22	12.39	6/84	504
SACLD07	24-32 oz Clear Dome Lid	7.375 x 7.375	.83	2.39	13.97	4/75	300
SACLF07	24-32 oz Clear Flat Lid	7.375 x 7.375	.26	2.39	12.64	4/75	300
SACLD09	48-64 oz Clear Dome Lid	9 x 9	.84	1.80	10.66	2/75	150
SACLF09	48-64 oz Clear Flat Lid	9 x 9	.49	1.80	9.67	2/75	150
SACLI07T	7.375" Insert for Square Salad	7.375 x 7.375	.26	0.83	8.57	2/150	300
SACLI09T	9" Insert for Square Salad	9 x 9	.26	0.67	6.21	2/75	150

# APET Produce Platter Collection – Bases & Lids

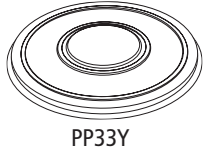

PP33Y



YPP0531

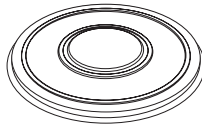

YPP2533

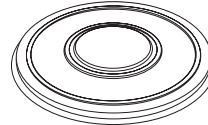

YPPP2933

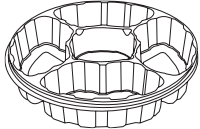

YPP25

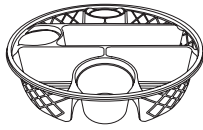
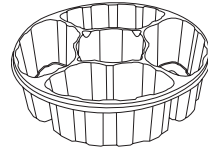
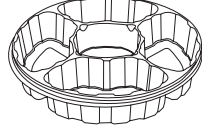

13D255CJ



1064DP3CLRL

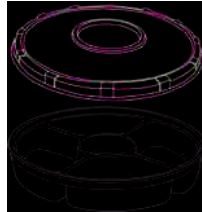

1064DP4CVL

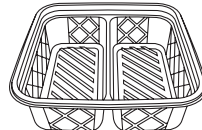

6SD202CJ

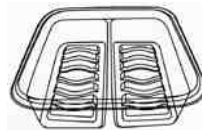

6S172CJ



6SD17DP3CJ

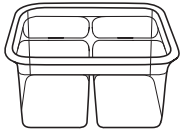

6S324C

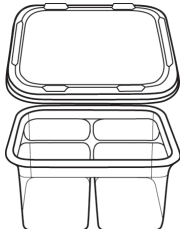

1064DP3CLRL



13220DP4C

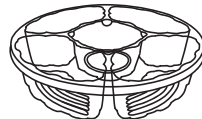

1325DD4CJ



1325DD4CJLD

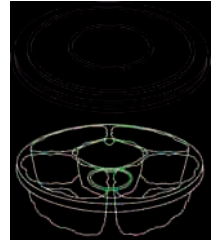

1325DD4CJLD

13VL

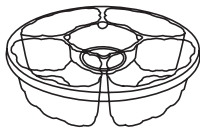

1325DP4C

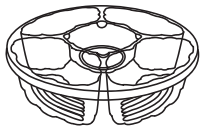

1330DP4CJ

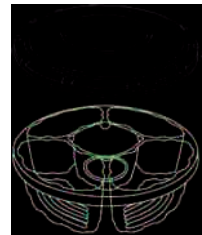

1340DD4CVL

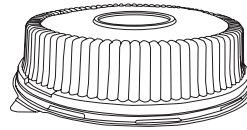

16D375DLT

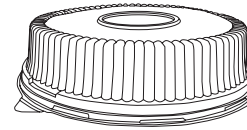

16DF375DLT

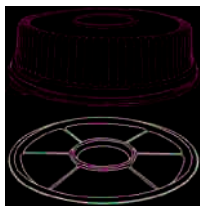

18D375DLT



18DF375DLT



13PP20SLT



13X19D0390



6SLRL

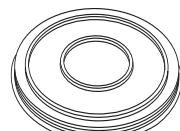

135CLID



13DL20T



13DLTSPK



11X145CILRL

**APET Produce Platter Collection – Bases & Lids**

Product Number	Description	Dimensions (in inches)	Case Pack	Case Weight	Case Cube	Cases/ Unit Load
YPP25	13" 4 Cmpt. Produce Platter w/ Dip Cup	13 x 2 5/8 x 2 1/4	55	16.71	2.46	42
YPP0531	10.25" 4 Cmpt. Produce Platter w/Dip Cup and Lid	10 1/4 x 2 3/4 x 1 1/2	120	29.48	5.29	24
YPP2533	13" 4 Cmpt. Produce Platter w/Dip Cup and Lid	13 x 2 3/4 x 2 1/4	60	25.07	4.47	24
YPP2933	13" 4 Cmpt. Produce Platter w/Dip Cup and Lid	13 x 4 x 3	30	14.18	2.46	42
13D255CJ	13" Produce Platter, 2.5" Dip Cup, 5 Cell w/Juice Trap	13 x 2.55	100	24.75	4.27	21
1064DP3CLRL	10" 64 oz. Platter, Dip Cup, 3 Cells, Leak Resistant Lid	10 x 3	100	22.12	4.54	25
1064DP4CLRL	10" 64 oz. Platter, Dip Cup, 4 Cells, Leak Resistant Lid	10 x 3	100	22.12	4.54	25
1064DP4CVL	10" 64 oz. Platter, Dip Cup, 4 Cells, Vented Lid	10 x 3	100	21.50	4.54	25
6SD202CJ	20 oz. Diamond Platter, 2 Cells w/Juice Trap	6.1 x 6.1 x 2 1/2	400	21.61	4.26	24
6S172CJ	17 oz. Square Clear Container, 2 Cells w/Juice Trap	6 1/8 x 6 1/8 x 1 5/6	300	14.00	4.60	21
6SD17DP3CJ	17 oz. Square Diamond Container, Dip Cup, 3 Cells w/Juice Trap	6 1/8 x 6 1/8 x 1 5/6	400	19.00	4.20	24
6S324C	32 oz. Square Clear Container, 4 Compartments	6 1/8 x 6 1/8 x 2 1/2	300	19.00	4.60	21
6S324CFL	6" 32 oz. Square Clear Container, 4 Cells w/Flat Lid	6 1/8 x 6 1/8 x 2 1/2	300	30.88	7.12	8
13220DP4C	13" Clear Platter 8 oz. Dip Cup, 4 Cells - Leak Resistant	12 4/7 x 2 1/5	100	23.00	4.20	21
1325DD4CJ	13" Clear Platter 12 oz. Dip Cup, 4 Cells w/Juice Trap - Leak Resistant	12 4/7 x 2 1/2	100	26.00	4.20	21
1325DD4CJLD	13" Clear Platter 12 oz. Dip Cup, 4 Cells w/Juice Trap, Lid	12 4/7 x 2 1/2	50	18.00	4.20	21
1325DD4CLID	13" Clear Platter 12 oz. Dip Cup, 4 Cells, Lid	12 4/7 x 2 1/2	50	18.00	4.20	21
1325DP4C	13" Clear Platter 8 oz. Dip Cup, 4 Cells - Leak Resistant	12 4/7 x 2 1/2	100	26.00	4.20	21
1330DP4CJ	13" Clear Platter 8 oz. Dip Cup, 4 Cells w/Juice Trap - Leak Resistant	12 4/7 x 3	100	26.00	4.20	21
1340DD4CVL	13" Clear Platter 16 oz. Dip Cup, 4 Cells, Vented Lid	12 4/7 x 4	50	21.00	4.20	21
16D375DLT	16" Round Deep Fluted Tabbed Dome w/Black Lazy Susan 6 Cmpt. Base	16 1/2 x 3 3/4	25	12.00	2.60	36
16DF375DLT	16" Round Deep Fluted Tabbed Dome w/Black Flat Base	16 1/2 x 3 3/4	25	12.00	2.60	36
18D375DLT	18" Round Deep Fluted Tabbed Dome w/Black Lazy Susan 6 Cmpt. Base	18 1/2 x 3 3/4	25	15.00	3.30	24
18DF375DLT	18" Round Deep Fluted Tabbed Dome w/Black Flat Base	18 1/2 x 3 3/4	25	17.00	3.30	24
13PP20SLT	12" Round Swirl Tabbed Leak Resistant Dome w/Black Base w/Standard 8 oz Deli Cup Dip Holder	12 4/7 x 2	50	15.00	4.00	30
13X19D0390	Oval 4" Deep Fluted Tabbed Dome w/Black Swirl Base	19 x 12 3/5 x 3 9/10	35	17.00	4.50	21
11X14124BDM4C	11" x 14" 124 oz. Black Platter, 4 Cells, Medium Dip Cup	14 1/4 x 11 x 3	75	22.08	2.39	45
<b>Lids</b>						
PP33Y	13" Lid	13	110	16.80	2.94	27
13VL	13" Vented Lid	13	100	12.00	3.60	30
6SLRL	6" Square Leak Resistant Lid	6 1/4	400	13.00	4.60	21
135CLID	13" Platter Lid - Leak Resistant	13	100	12.00	3.60	30
13DL20T	13" Dome Lid 2" High w/Tab	13 x 2	100	18.52	3.67	30
13DLTSPK	13" Dome Lid Spike & Tab Trim	13 x 1.42	100	16.12	4.27	21
11X145CILRL	Individual Cell Leak Resistant Lid	14 1/4 x 11	75	12.00	2.30	45







---

# Deli Packaging

---

Product Number	Description	Page
0CA910080000	8 OZ. CLEARVIEW™ HINGED LID DELI CONTAINER - RPET	D23
0CA910120000	12 OZ. CLEARVIEW HINGED LID DELI CONTAINER - RPET	D23
0CA910160000	16 OZ. CLEARVIEW HINGED LID DELI CONTAINER - RPET	D23
0CASH0970	8" X 8" 1-CMPT. CLEAR HINGED BAKERY CONTAINER - RPET	D21
0CASH1030	MEDIUM 1-CMPT. CLEAR HINGED CONTAINER - DEEP - RPET	D21
0CASH1110	LARGE 1-CMPT. CLEAR HINGED CONTAINER - RPET	D21
0CASH1120	MEDIUM 1-CMPT. CLEAR HINGED CONTAINER - RPET	D21
0CASH1123	MEDIUM 3-CMPT. CLEAR HINGED CONTAINER - RPET	D21
0CASH1124	MEDIUM CLEAR HINGED COOKIE CONTAINER - RPET	D21
0CASH3025	LARGE CLEAR HINGED STRUDEL CONTAINER - RPET	D21
0CASH9140	CLEAR HINGED 4 COUNT MUFFIN CONTAINER - RPET	D21
0CASH9446	CLEAR 12 CUP CUPCAKE/MUFFIN HINGED CONTAINER - RPET	D21
0CNC10700DZ	MEALMASTER® HALF SLAB COMBO ZIP SEAL™ W/FOG GARD™	D7
1040PSSL	40 OZ. CLEAR SWIRL BOWL W/STANDARD DOME LID - APET	D23
1040SJSL	40 OZ. CLEAR SWIRL BOWL W/STANDARD DOME LID JUICE CATCHER - APET	D23
1064PSSL	64 OZ. CLEAR SWIRL BOWL W/STANDARD DOME LID - APET	D23
10747	ULTRA PAC CLEAR 1-CMPT. HINGEWARE - PETE	D21
10777	ULTRA PAC CLEAR 1-CMPT. HINGEWARE - PETE	D21
1080PIL90	80 OZ. CLEAR SWIRL BOWL W/STANDARD DOME LID - APET	D23
10817	ULTRA PAC CLEAR 1-CMPT. HINGEWARE - PETE	D21
10839APT	8 OZ. CLEAR ROUND SHO-BOWLS® HINGEWARE W/FLAT LID	D27
10841APT	8 OZ. CLEAR ROUND SHO-BOWLS® HINGEWARE W/DOME LID	D27
10845APT	12 OZ. CLEAR ROUND SHO-BOWLS® HINGEWARE W/DOME LID	D27
10847APT	16 OZ. CLEAR ROUND SHO-BOWLS® HINGEWARE W/FLAT LID	D27
10849APT	16 OZ. CLEAR ROUND SHO-BOWLS® HINGEWARE W/DOME LID	D27
10851APT	56 OZ. CLEAR ROUND SHO-BOWLS® HINGEWARE W/FLAT LID	D27
10853APT	56 OZ. CLEAR ROUND SHO-BOWLS® HINGEWARE W/RIBBED DOME LID	D27
10857APT	16 OZ. CLEAR ROUND SHO-BOWLS® HINGEWARE W/DOME LID	D27
10863APT	32 OZ. CLEAR ROUND SHO-BOWLS® HINGEWARE W/FLAT LID	D27
10865APT	32 OZ. CLEAR ROUND SHO-BOWLS® HINGEWARE W/DOME LID	D27
10869APT	39 OZ. CLEAR ROUND SHO-BOWLS® HINGEWARE W/DOME LID	D27
1096PSSL	96 OZ. CLEAR SWIRL BOWL W/STANDARD DOME LID - APET	D23
11326	ULTRA PAC® CLEAR HINGED LUNCH BOX CONTAINER	D21
11334	ULTRA PAC® CLEAR HINGED SANDWICH WEDGE	D21
11431	ULTRA PAC CLEAR 1-CMPT. HINGEWARE - PETE	D21
11733	CLEAR HERB CLAMSHELL W/TAB	D27
11734	CLEAR HERB CLAMSHELL	D27
11970	REYNOLDS® 10" HINGEWARE	D13
11974	REYNOLDS® 6" ENHANCED HINGEWARE	D13
12016	REYNOLDS® 5" ENHANCED HINGEWARE	D13
12091	REYNOLDS® 44 OZ. OCTAGONAL CLAMSHELL	D27
12092	REYNOLDS® 33 OZ. OCTAGONAL CLAMSHELL	D27
12093	REYNOLDS® 29 OZ. OCTAGONAL CLAMSHELL	D27
12094	REYNOLDS® 22 OZ. OCTAGONAL CLAMSHELL	D27
12095	REYNOLDS® 19 OZ. OCTAGONAL CLAMSHELL	D27
12096	REYNOLDS® 16 OZ. OCTAGONAL CLAMSHELL	D27
13173	REYNOLDS® 30 OZ. OCTAGONAL CLAMSHELL	D27
13223	REYNOLDS® 8/8/8/4 OZ. 4 COMPARTMENT OCTAGONAL CLAMSHELL	D27
12481	ULTRA PAC® 1-CMPT CLEAR HINGE HOAGIE CONTAINER W/BLACK BASE	D21
12761	GRANDSTAND™ 18 OZ. CLEAR HINGED LID BOWL W/BLACK BASE	D25
12807	GRANDSTAND™ 18 OZ. CLEAR HINGED LID BOWL	D25
12808	GRANDSTAND™ 28 OZ. CLEAR HINGED LID BOWL	D25
12809	GRANDSTAND™ 35 OZ. CLEAR HINGED LID BOWL	D25
12811	GRANDSTAND™ 54 OZ. CLEAR HINGED LID BOWL	D25
13643	FLIP N STACK® CONTAINER	D25
2155P300	REYNOLDS® SQUARE HINGED BAR-LOCK	D13
2170P200	REYNOLDS® LARGE SQUARE HINGED BAR-LOCK	D13
2175	REYNOLDS® SMALL DANISH HINGED BAR-LOCK	D13
2221	REYNOLDS® 5" SQUARE HINGED BAR-LOCK	D13
6026-30	1 LB OBLONG ENTREE	D5
6036-30	2-COMPARTMENT OBLONG HAMBURGER	D5
6236-30	2-COMPARTMENT DEEP OBLONG HAMBURGER	D5
6326-30	DEEP OBLONG	D5
664WP	SQUARE CAKE PACKAGE W/DOME	D3
6707WPSFG	OVAL FOIL BASE W/DOME LID W/FOG GARD COATING	D3
6708WPSFG	SINGLE SERVE BLACK/GOLD FOIL BASE W/FOG GARD DOME LID	D3
6708WPZFG	SINGLE SERVE BLACK/GOLD FOIL BASE W/FOG GARD FLAT LID	D3
6711WP	LG BLACK EXTERIOR/GOLD FOIL INTERIOR BASE W/DOME LID	D3
69107-30	2-COMPARTMENT DEEP OBLONG HOT DOG	D3
69310TP	3-COMPARTMENT OBLONG W/BOARD COVER	D3
65172CJ	17 OZ. APET SQUARE CLEAR CONTAINER, 2 CELLS W/JUICE TRAP	D25
6520DBHD	20 OZ. APET SQUARE CLEAR CONTAINER W/DOME BOTTOM	D25
6524	24 OZ. APET SQUARE CLEAR CONTAINER	D25
6532	32 OZ. APET SQUARE CLEAR CONTAINER	D25
65322C	32 OZ. APET SQUARE CLEAR 2-CMPT. CONTAINER	D25
65324C	32 OZ. APET SQUARE CLEAR 4-CMPT. CONTAINER	D25
6548	48 OZ. APET SQUARE CLEAR CONTAINER	D25
6560	60 OZ. APET SQUARE CLEAR CONTAINER	D25
6584	84 OZ. APET SQUARE CLEAR CONTAINER	D25
65D17DP3CJ	17 OZ. APET SQUARE CLEAR CONTAINER, 2 CELLS W/JUICE TRAP	D25
65DLRED	6" APET SQUARE RED DOME LID	D25
65FL	6" APET SQUARE FLAT LID	D25
65LRL	6" APET SQUARE LEAK RESISTANT LID	D25
7089TP	4-COMPARTMENT OBLONG W/ BOARD COVER	D3
716PSSL	16 OZ. CLEAR SWIRL BOWL W/STANDARD DOME - APET	D23
718BPSSL	18 OZ. CLEAR SWIRL BOWL W/STANDARD DOME - APET	D23
718PSSL	18 OZ. CLEAR SWIRL BOWL W/STANDARD DOME - APET	D23
7239TP	3-COMPARTMENT OBLONG W/ BOARD COVER	D3
724PSSL	24 OZ. CLEAR SWIRL BOWL W/STANDARD DOME - APET	D23
724SJSL	24 OZ. CLEAR SWIRL BOWL W/ DOME JUICE CATCHER - APET	D23
732PSSL	32 OZ. CLEAR SWIRL BOWL W/STANDARD DOME - APET	D23

Product Number	Description	Page
7325JSJL	32 OZ. CLEAR SWIRL BOWL W/ DOME JUICE CATCHER - APET	D23
732UPSRDL	32 OZ. STANDING SWIRL CLEAR BOWL W/DOME - APET	D23
747PSSL	48 OZ. CLEAR SWIRL BOWL W/STANDARD DOME - APET	D23
788TP	MEDIUM OBLONG W/ BOARD COVER	D3
75L	7" SWIRL LID - APET	D23
85104	104 OZ. APET SQUARE CLEAR CONTAINER	D25
85115	115 OZ. APET SQUARE CLEAR CONTAINER	D25
85128	128 OZ. APET SQUARE CLEAR CONTAINER	D25
8540	40 OZ. APET SQUARE CLEAR CONTAINER	D25
8564	99 OZ. APET SQUARE CLEAR CONTAINER	D25
8599	40 OZ. APET SQUARE CLEAR CONTAINER	D25
85NL	8" APET SQUARE FLAT LID	D25
95240W	CLEARVIEW WHITE PORTION PLATTER	D15
95940K	CLEARVIEW BLACK PORTION PLATTER	D15
C18-0615	CLEAR DOME LID FOR 0615EP ROUND BOWL	D9
C18-1030	SMARTLOCK CLEAR MEDIUM HINGED LID CONTAINER - DEEP	D11
C18-5012	CLEAR 12 OZ. CONTAINER	D13
C18-5016	CLEAR 16 OZ. CONTAINER	D13
C18-5100	CLEAR SNAP-ON LID FOR 8, 12, 16 OZ. CONTAINERS	D13
C18-5101	CLEAR SNAP-ON DOME LID FOR 8, 12, 16 OZ. CONTAINERS	D13
C18 5613	CLEAR DOME FOR PRESSWARE 5613 CONTAINER	D9, D11
C18 5613R	CLEAR DOME FOR PRESSWARE 5613R CONTAINER	D9, D11
C18 5615	CLEAR DOME FOR PRESSWARE 4512, 5615 CONTAINERS	D9, D11
C18 5710	CLEAR HIGH DOME FOR PRESSWARE 5710, 5713 CONTAINERS	D9, D11
C18 5713	CLEAR LOW DOME FOR PRESSWARE 5710, 5713 CONTAINERS	D9, D11
C18 5713R	CLEAR DOME FOR PRESSWARE 5713R, 5716R CONTAINERS	D9, D11
C18-6008	CLEAR 8 OZ. CONTAINER W/FLAT LID	D15
C18-6012	CLEAR 12 OZ. CONTAINER W/FLAT LID	D15
C18-6016	CLEAR 16 OZ. CONTAINER W/FLAT LID	D15
C18-6048	CLEAR 48 OZ. CONTAINER W/FLAT LID	D15
C18-6064	CLEAR 64 OZ. CONTAINER W/FLAT LID	D15
C18 6815	CLEAR DOME FOR PRESSWARE 6815 CONTAINER	D9, D11
C18 6816	CLEAR DOME FOR PRESSWARE 6816 CONTAINER	D9, D11
CN8-4616	16 OZ. BLACK CLEARVIEW MEALMASTER TRAY	D9
CN8-4624	24 OZ. BLACK CLEARVIEW MEALMASTER TRAY	D9
CN8-4632	32 OZ. BLACK CLEARVIEW MEALMASTER TRAY	D9
CN8-4636	36 OZ. BLACK CLEARVIEW MEALMASTER 1 COMPARTMENT TRAY	D9
CN8-4637	21 OZ., 10 OZ. BLACK CLEARVIEW™ MEALMASTER® 2 COMP. TRAY	D9
CN8-4638	21 OZ., 4.5 OZ., 4.5 OZ. BLACK CLEARVIEW™ MEALMASTER® 3 COMP. TRAY	D9
CN8-463SD	CLEARVIEW™ LARGE FLAT LID W/FOG GARD™ COATING	D9
CN8-466HD	CLEARVIEW™ LARGE 1 COMPARTMENT DOME LID W/FOG GARD™ COATING	D9
CN8-467HD	CLEARVIEW™ LARGE 2 COMPARTMENT DOME LID W/FOG GARD™ COATING	D9
CN8-468HD	CLEARVIEW™ LARGE 3 COMPARTMENT DOME LID W/FOG GARD™ COATING	D9
CN8-5008	8 OZ. BLACK CLEARVIEW™ MICROMAX® CONTAINER	D5
CN8-5012	12 OZ. BLACK CLEARVIEW™ MICROMAX® CONTAINER	D5
CN8-5016	16 OZ. BLACK CLEARVIEW™ MICROMAX® 16 OZ. CONTAINER	D5
CN8-5024	24 OZ. BLACK CLEARVIEW™ MICROMAX® CONTAINER	D5
CN8-5032	32 OZ. BLACK CLEARVIEW™ MICROMAX® CONTAINER	D5
CN8-5100	CLEAR SNAP-ON LID - 8 & 12 OZ. CONTAINERS	D5
CN8-5200	CLEAR SNAP-ON LID - 16, 24 & 32 OZ. CONTAINERS	D5
CN8-5301	CLEAR SNAP-ON DOME LID FOR 2 & 3 CMPT CONTS W/FOG-GARD™	D5
CN8-5512	12 OZ. CLEARVIEW™ MICROMAX® BLACK OVAL BASE	D7
CN8-5516	16 OZ. CLEARVIEW™ MICROMAX® BLACK OVAL BASE	D7
CN8-5524	24 OZ. CLEARVIEW™ MICROMAX® BLACK OVAL BASE	D7
CNC-3002	CLEARVIEW™ MEALMASTER® SMALL CHICKEN BARN CONTAINER	D7
CNC-3016	CLEARVIEW™ MEALMASTER® LARGE CHICKEN BARN CONTAINER	D7
FL500Y	NEWSRING DELTAINER® OVERCAP LID FOR 8-32 CONTAINERS	D19
L5008Y	8 OZ. NEWSRING DELTAINER® CLEAR DELI CONTAINER BULK PACK	D19
L5012Y	12 OZ. NEWSRING DELTAINER® CLEAR DELI CONTAINER BULK PACK	D19
L5020Y	20 OZ. NEWSRING DELTAINER® CLEAR DELI CONTAINER BULK PACK	D19
L5024Y	24 OZ. NEWSRING DELTAINER® CLEAR DELI CONTAINER BULK PACK	D19
L6064	64 OZ. NEWSRING DELTAINER® CLEAR DELI TUB BULK PACK	D21
L-7080-N	80 OZ. NEWSRING DELTAINER® NATURAL DELI TUB	D21
L-7128-N	128 OZ. NEWSRING DELTAINER® NATURAL DELI TUB	D21
L-7168	16 OZ. NEWSRING DELTAINER® CLEAR SQUAT CONTAINER & LID	D19
L-8128-N	128 OZ. NEWSRING DELTAINER® SQUAT NATURAL DELI TUB	D21
L-8160-N	160 OZ. NEWSRING DELTAINER® NATURAL DELI TUB	D21
L-8328	32 OZ. NEWSRING DELTAINER® CLEAR SQUAT CONTAINER & LID	D19
LRW48140	48 OZ. CLEAR ROSEWARE® BOWL W/STANDARD DOME LID - APET	D23
NC-333	12 OZ. NEWSRING VERSATAINER® 3 CMPT WHITE RECT BASE & CLEAR LID	D17
NC-333-B	12 OZ. NEWSRING VERSATAINER® 3 CMPT BLACK RECT BASE & CLEAR LID	D17
NC-626	26 OZ. NEWSRING VERSATAINER WHITE SQUARE BASE & CLEAR LID	D17
NC-626-B	26 OZ. NEWSRING VERSATAINER BLACK SQUARE BASE & CLEAR LID	D17
NC-636	36 OZ. NEWSRING VERSATAINER WHITE SQUARE BASE & CLEAR LID	D17
NC-636-B	36 OZ. NEWSRING VERSATAINER BLACK SQUARE BASE & CLEAR LID	D17
NC-718	16 OZ. NEWSRING VERSATAINER WHITE ROUND BASE & CLEAR LID	D19
NC-718-B	16 OZ. NEWSRING VERSATAINER BLACK ROUND BASE & CLEAR LID	D19
NC-723	24 OZ. NEWSRING VERSATAINER WHITE ROUND BASE & CLEAR LID	D19
NC-723-B	24 OZ. NEWSRING VERSATAINER BLACK ROUND BASE & CLEAR LID	D19
NC-729	32 OZ. NEWSRING VERSATAINER WHITE ROUND BASE & CLEAR LID	D19
NC-729-B	32 OZ. NEWSRING VERSATAINER BLACK ROUND BASE & CLEAR LID	D19
NC-737	35 OZ. NEWSRING VERSATAINER WHITE ROUND BASE & CLEAR LID	D19
NC-737-B	35 OZ. NEWSRING VERSATAINER BLACK ROUND BASE & CLEAR LID	D19
NC-8168	16 OZ. NEWSRING VERSATAINER WHITE RECT BASE & CLEAR LID	D17
NC-8168-B	16 OZ. NEWSRING VERSATAINER BLACK RECT BASE & CLEAR LID	D17
NC-8168-BV	16 OZ. NEWSRING VERSATAINER BLACK RECT BASE & VENTED CLEAR LID	D17
NC-818	12 OZ. NEWSRING VERSATAINER WHITE RECT BASE & CLEAR LID	D17
NC-818-B	12 OZ. NEWSRING VERSATAINER BLACK RECT BASE & CLEAR LID	D17
NC-8288	30 OZ. NEWSRING VERSATAINER 2 CMPT WHITE RECT BASE & CLEAR LID	D17
NC-8288-B	30 OZ. NEWSRING VERSATAINER 2 CMPT BLACK RECT BASE & CLEAR LID	D17
NC-838	24 OZ. NEWSRING VERSATAINER WHITE RECT BASE & CLEAR LID	D17

Product Number	Description	Page
NC-838-B	24 OZ NEWSPRING VERSATAINER BLACK RECT BASE & CLEAR LID	D17
NC-838-BV	24 OZ NEWSPRING VERSATAINER BLACK RECT BASE & VENTED CLEAR LID	D17
NC-868	28 OZ NEWSPRING VERSATAINER WHITE RECT BASE & CLEAR LID	D17
NC-868-B	28 OZ NEWSPRING VERSATAINER BLACK RECT BASE & CLEAR LID	D17
NC-888	38 OZ NEWSPRING VERSATAINER WHITE RECT BASE & CLEAR LID	D17
NC-888-B	38 OZ NEWSPRING VERSATAINER BLACK RECT BASE & CLEAR LID	D17
NC-9388	48 OZ NEWSPRING VERSATAINER 3 CMPT WHITE ROUND BASE & CLEAR LID	D19
NC-9388-B	48 OZ NEWSPRING VERSATAINER 3 CMPT BLACK ROUND BASE & CLEAR LID	D19
NC-948	48 OZ NEWSPRING VERSATAINER WHITE ROUND BASE & CLEAR LID	D19
NC-948-B	48 OZ NEWSPRING VERSATAINER BLACK ROUND BASE & CLEAR LID	D19
NC-948-BV	48 OZ NEWSPRING VERSATAINER BLACK ROUND BASE & VENTED CLEAR LID	D19
NC-989	58 OZ NEWSPRING VERSATAINER® WHITE RECT BASE & CLEAR LID	D17
NC-989-B	58 OZ NEWSPRING VERSATAINER® BLACK RECT BASE & CLEAR LID	D17
NL-640	NEWSPRING DELTAINER LID FOR 48 & 64 OZ TUBS	D21
NL-740	NEWSPRING DELTAINER LID FOR 80, 96, 112, 128 OZ TUBS	D21
NL-810	NEWSPRING DELTAINER LID FOR 112, 128, 144, 160 OZ TUBS	D21
OC-06	6 OZ NEWSPRING VERSATAINER® WHITE OVAL BASE & CLEAR LID	D17
OC-06-B	6 OZ NEWSPRING VERSATAINER® BLACK OVAL BASE & CLEAR LID	D17
OC-08	8 OZ NEWSPRING VERSATAINER® WHITE OVAL BASE & CLEAR LID	D17
OC-08-B	8 OZ NEWSPRING VERSATAINER® BLACK OVAL BASE & CLEAR LID	D17
OC-12	12 OZ NEWSPRING VERSATAINER® WHITE OVAL BASE & CLEAR LID	D17
OC-12-B	12 OZ NEWSPRING VERSATAINER® BLACK OVAL BASE & CLEAR LID	D17
OC-16	16 OZ NEWSPRING VERSATAINER® WHITE OVAL BASE & CLEAR LID	D17
OC-16-B	16 OZ NEWSPRING VERSATAINER® BLACK OVAL BASE & CLEAR LID	D17
OC-24	24 OZ NEWSPRING VERSATAINER® WHITE OVAL BASE & CLEAR LID	D17
OC-24-B	24 OZ NEWSPRING VERSATAINER® BLACK OVAL BASE & CLEAR LID	D17
OC-32	32 OZ NEWSPRING VERSATAINER® WHITE OVAL BASE & CLEAR LID	D17
OC-32-B	32 OZ NEWSPRING VERSATAINER® BLACK OVAL BASE & CLEAR LID	D17
PCS 0D52	PRESSWARE® CLASSIC STONWARE® ROUND TRAY	D9
PCS 4403	PRESSWARE® CLASSIC STONWARE® SQUARE TRAY (UNCOATED)	D9
PCS 4D52	PRESSWARE® CLASSIC STONWARE® SQUARE TRAY	D9
PCS 4D53	PRESSWARE® CLASSIC STONWARE® SQUARE TRAY	D9
PCS 4512	PRESSWARE® CLASSIC STONWARE® OBLONG TRAY	D9
PCS 5611R	PRESSWARE® CLASSIC STONWARE® OBLONG TRAY (ROUNDED CORNERS)	D9
PCS 5613	PRESSWARE® CLASSIC STONWARE® OBLONG TRAY	D9
PCS 5613RR1	PRESSWARE® CLASSIC STONWARE® OBLONG TRAY (ROUNDED CORNERS)	D9
PCS 5615	PRESSWARE® CLASSIC STONWARE® OBLONG TRAY	D9
PCS 5710	PRESSWARE® CLASSIC STONWARE® OBLONG TRAY	D9
PCS 5713	PRESSWARE® CLASSIC STONWARE® OBLONG TRAY	D9
PCS 5713R	PRESSWARE® CLASSIC STONWARE® SHALLOW OBLONG TRAY (ROUNDED CORNERS)	D9
PCS 5715R	PRESSWARE® CLASSIC STONWARE® OBLONG TRAY (ROUNDED CORNERS)	D9
PCS 5716R	PRESSWARE® CLASSIC STONWARE® DEEP OBLONG TRAY (ROUNDED CORNERS)	D9
PCS 5811R	PRESSWARE® CLASSIC STONWARE® OBLONG TRAY (ROUNDED CORNERS)	D9
PCS 6815	PRESSWARE® CLASSIC STONWARE® OBLONG TRAY	D9
PCS 6816	PRESSWARE® CLASSIC STONWARE® OBLONG TRAY	D9
PCS 7014	PRESSWARE® CLASSIC STONWARE® OBLONG TRAY	D9
PEP 4512	PRESSWARE® EBONY PREMIER® OBLONG TRAY	D11
PEP 5613RR1	PRESSWARE® EBONY PREMIER® OBLONG TRAY (ROUNDED CORNERS)	D11
PEP 5615	PRESSWARE® EBONY PREMIER® OBLONG TRAY	D11
PEP 5713R	PRESSWARE® EBONY PREMIER SHALLOW OBLONG TRAY (ROUNDED CORNERS)	D9, D11
PEP 5715R	PRESSWARE® EBONY PREMIER® OBLONG TRAY (ROUNDED CORNERS)	D9
PEP 5716R	PRESSWARE® EBONY PREMIER® DEEP OBLONG TRAY (ROUNDED CORNERS)	D9
PEP 6815	PRESSWARE® EBONY PREMIER® OBLONG TRAY	D11
PEP 6816	PRESSWARE® EBONY PREMIER® OBLONG TRAY	D11
PEP 7014	PRESSWARE® EBONY PREMIER® OBLONG TRAY	D11
PSP 0615EP	PRESSWARE® EBONY PREMIER® ROUND DELI BOWL	D9
SD5016Y	16 OZ NEWSPRING DELTAINER® CLEAR DELI CONTAINER BULK PACK	D19
SD5032Y	32 OZ NEWSPRING DELTAINER® CLEAR DELI CONTAINER BULK PACK	D19
SQ32DB	32 OZ. TIMESQUARE™E CLEAR DELI CONTAINER - DOMED BOTTOM	D23
SR1-0708	QUART SIZE HEFTY® FAST-PAK® UTILITY BAG	D5
SR1-1111	GALLON SIZE HEFTY FAST-PAK UTILITY BAG	D5
TE08	8 OZ. NEWSPRING TAMPER EVIDENT CONTAINER	D21
TE12	12 OZ. NEWSPRING TAMPER EVIDENT CONTAINER	D21
TE16	16 OZ. NEWSPRING TAMPER EVIDENT CONTAINER	D21
TE32	32 OZ. NEWSPRING TAMPER EVIDENT CONTAINER	D21
TE48	48 OZ. NEWSPRING TAMPER EVIDENT CONTAINER	D21
TEL160	NEWSPRING TAMPER EVIDENT 8,12,16 OZ LID	D21
TEL320	NEWSPRING TAMPER EVIDENT 32 OZ LID	D21
TEL480	NEWSPRING TAMPER EVIDENT 48 OZ LID	D21
TL500Y	NEWSPRING DELTAINER® OVERCAP LID FOR 8-32 CONTAINERS	D19
Y4S12	12 OZ. TIMESQUARE™ CLEAR DELI CONTAINER	D23
Y4S18	16 OZ. TIMESQUARE™ CLEAR DELI CONTAINER	D23
Y4S24	24 OZ. TIMESQUARE™ CLEAR DELI CONTAINER	D23
Y4S24DB	24 OZ. TIMESQUARE™ CLEAR DELI CONTAINER - DOMED BOTTOM	D23
Y4S32	32 OZ. TIMESQUARE™ CLEAR DELI CONTAINER	D23
Y4S8	8 OZ. TIMESQUARE™ CLEAR DELI CONTAINER	D23
Y4SAL	TIMESQUARE™ 4" SQUARE FLAT LID	D23
Y4SFL	TIMESQUARE™ 4" SQUARE FLAT RECESSED LID	D23
Y512PSSL	12 OZ. CLEAR SWIRL BOWL W/STANDARD DOME - APET	D23
Y516PSSL	16 OZ. CLEAR SWIRL BOWL W/STANDARD DOME - APET	D23
Y58PSSL	8 OZ. CLEAR SWIRL BOWL W/STANDARD DOME - APET	D23
YCN8462H00D0	MEALMASTER® MED DOME LID W/FOG GARD™	D9
YCN8462S00D0	MEALMASTER® MED FLAT LID W/FOG GARD™	D9
YCN8463S00D0	MEALMASTER® LARGE FLAT LID W/FOG GARD™	D9
YCN8466H00D0	MEALMASTER® LARGE DOME LID W/FOG GARD™	D9
YCN8467H00D0	MEALMASTER® LARGE 2-CMPT. LID W/FOG GARD™	D9
YCN8468H00D0	MEALMASTER® LARGE 3-CMPT. LID W/FOG GARD™	D9
Y6710WPSFG	SM BLACK /GOLD FOIL BASE W/FOG GARD™ DOME LID	D3
Y6710WPZFG	SM BLACK /GOLD FOIL BASE W/FOG GARD™ FLAT LID	D3
Y7139TP	3-COMPARTMENT OBLONG W/ BOARD COVER	D3
Y7139TPP	3-COMPARTMENT OBLONG W/ OVENABLE PAPER COVER	D3

Product Number	Description	Page
Y9197	4 OZ SHOWCASE® CONTAINER	D13
Y9198	6 OZ SHOWCASE® CONTAINER	D13
Y92008U	8 OZ SHOWCASE® DESIGNER BOWL	D13
Y92012	12 OZ SHOWCASE® DESIGNER BOWL	D13
Y92016U	16 OZ SHOWCASE® DESIGNER BOWL	D13
Y92025K	24 OZ BLACK SHOWCASE® DESIGNER BOWL	D13
Y92025U	24 OZ SHALLOW SHOWCASE® DESIGNER BOWL	D13
Y92032K	32 OZ BLACK SHOWCASE® DESIGNER BOWL	D13
Y92032U	32 OZ SHOWCASE® DESIGNER BOWL	D13
Y92032SCHU	32 OZ BOWL COMBO W/DOME	D13
Y92048	48 OZ SHOWCASE® DESIGNER BOWL	D13
Y92164SCU	64 OZ BOWL COMBO W/SNAP-ON LID/SHOWCAKE MINI-CAKE PKG.	D13
Y94111	THE SELL OUT® LARGE NON-CMPT. DEEP HINGEWARE	D11
Y94119	THE SELL OUT® LARGE SUPER DEEP HINGEWARE	D11
Y94121	THE SELL OUT® MEDIUM NON-CMPT. DEEP HINGEWARE	D11
Y94130	THE SELL OUT® MED. NON-CMPT. HINGEWARE	D11
Y95200W	CLEARVIEW™ WHITE ENTREE PLATTER	D15
Y95900K	CLEARVIEW™ BLACK ENTREE PLATTER	D15
Y95970K	CLEARVIEW™ BLACK SHALLOW MEDIUM PLATTER	D15
Y95980K	CLEARVIEW™ BLACK DEEP MEDIUM PLATTER	D15
Y96100KEP	CLEARVIEW™ LARGE BLACK PLATTER W/DOME	D15
Y96140KPP	CLEARVIEW™ BLACK PORTION PLATTER W/DOME	D15
Y96180KPP	CLEARVIEW™ MEDIUM BLACK PLATTER W/DOME	D15
Y96180PP	CLEARVIEW™ MEDIUM CLEAR PLATTER W/DOME	D15
YCA910240000	24 OZ. CLEARVIEW HINGED LID DELI CONTAINER - RPET	D23
YCA910320000	32 OZ. CLEARVIEW HINGED LID DELI CONTAINER - RPET	D23
YCA910480000	48 OZ. CLEARVIEW™ HINGED LID DELI CONTAINER - RPET	D23
YCA910640000	64 OZ. CLEARVIEW™ HINGED LID DELI CONTAINER - RPET	D23
YCASH1050	5" CLEAR HINGED CONTAINER - RPET	D21
YCASH1160	6" CLEAR HINGED CONTAINER - RPET	D21
YCI8-0960	SMARTLOCK® FOOT-LONG HINGEWARE	D11
YCI8-1045	SMARTLOCK® CLEAR SINGLE TAB HOTDOG CONTAINER	D11
YCI8-1048	SMARTLOCK® CLEAR 7 1/2" SLIM BIN PACKAGE	D11
YCI8-1049	SMARTLOCK® CLEAR 9" SLIM BIN PACKAGE	D11
YCI8-1050	SMARTLOCK® CLEAR 5" SMARTLOCK HINGED LID W/1-CMPT. TRAY	D11
YCI8-1110	SMARTLOCK® CLEAR LARGE HINGED LID W/1-CMPT. TRAY	D11
YCI8-1113	SMARTLOCK® CLEAR LARGE HINGED LID W/3-CMPT. TRAY	D11
YCI8-1120	SMARTLOCK® CLEAR MEDIUM HINGED LID W/1-CMPT. TRAY	D11
YCI8-1123	SMARTLOCK® CLEAR MEDIUM HINGED LID W/3-CMPT. TRAY	D11
YCI8-1160	SMARTLOCK® CLEAR 6" HINGED LID W/1-CMPT. TRAY	D11
YCI8-2025	SMARTLOCK® CLEAR SMALL HINGED LID	D11
YCI8-2030	SMARTLOCK® CLEAR HINGED LID W/1-CMPT. TRAY (SS)	D11
YCI8-2035	SMARTLOCK® CLEAR HINGED LID W/1-CMPT. TRAY (DS)	D11
YCI8-2040	SMARTLOCK® CLEAR HINGED LID W/1-CMPT. TRAY (DD)	D11
YCI8-3035	SMARTLOCK® CLEAR UTILITY (DS)	D11
YCI8-5008	CLEAR 8 OZ. CONTAINER	D13
YCI8-5024	CLEAR 24 OZ. CONTAINER	D13
YCI8-5032	CLEAR 32 OZ. CONTAINER	D13
YCI8-5048	CLEAR 48 OZ. CONTAINER	D13
YCI8-5064	CLEAR 64 OZ. CONTAINER	D13
YCI8-5200	CLEAR SNAP-ON LID FOR 24, & 32 OZ. CONTAINERS	D13
YCI8-5201	CLEAR SNAP-ON DOME LID FOR 24, & 32 OZ. CONTAINERS	D13
YCI8-5300	CLEAR SNAP-ON LID FOR 2 & 3 CMPT. CONTAINERS	D5, D13
YCI8-5301	CLEAR SNAP-ON DOME LID FOR 48 & 64 OZ. CONTAINERS	D13
YCI8-5420	CLEAR 2-CMPT. OBLONG CONTAINER	D13
YCI8-5430	CLEAR 3-CMPT. OBLONG CONTAINER	D13
YCI8-5435	CLEAR 3-CMPT. DIAGONAL CONTAINER	D13
YCI8-6024	CLEAR 24 OZ. CONTAINER W/FLAT LID	D15
YCI8-6032	CLEAR 32 OZ. CONTAINER W/FLAT LID	D15
YCI8-8062	CLEARVIEW 2-CMPT. NACHO TRAY	D15
YCI8-8063	CLEARVIEW 1-CMPT. TRAY W/LID - COMBO PACK	D15
YCI8-8068	CLEARVIEW LARGE 2-CMPT. NACHO TRAY	D15
YCI8 D7140001	CLEAR DOME FOR PRESSWARE 7014 CONTAINER	D9, D11
YCN8-4608	8 OZ. BLACK CLEARVIEW MEALMASTER™ TRAY	D7
YCN8-460HD	CLEARVIEW™ SMALL DOME LID W/FOG GARD™ COATING	D7
YCN8-4612	12 OZ. BLACK CLEARVIEW MEALMASTER TRAY	D7
YCN8-462HD	CLEARVIEW MEDIUM DOME LID W/FOG GARD COATING	D9
YCN8-462S	CLEARVIEW MEDIUM FLAT LID W/FOG GARD COATING	D9
YCN8-5101D	CLEAR SNAP-ON DOME - 8 & 12 OZ. CONTAINERS W/FOG-GARD	D5
YCN8-5201D	CLEAR SNAP-ON DOME -16, 24, & 32 OZ. CONTAINERS W/FOG-GARD	D5
YCN8-5301D	CLEAR SNAP-ON DOME -2 & 3 CMPT. CONTAINERS W/FOG-GARD	D5
YCN8-5420	CLEARVIEW™ MICROMAX® BLACK 2-CMPT. OBLONG CONTAINER	D5
YCN8-5430	CLEARVIEW™ MICROMAX® BLACK 3-CMPT. OBLONG CONTAINER	D5
YCN8-5501D	CLEAR SNAP-ON LID FOR 12 & 16 OZ. OVALS	D7
YCN8-5502D	CLEAR SNAP-ON LID FOR 24 OZ. OVALS	D7
YCN8-6516D	16 OZ. BASE W/CLEAR LID W/FOG-GARD COATING - COMBO PACK	D7
YCN167000DZ	MEALMASTER® FULL SLAB COMBO ZIP SEAL™ W/FOG GARD™	D7
YCN1670DDZ	MEALMASTER® FULL SLAB COMBO ZIP SEAL™ W/FOG GARD™-DEEP DOME	D7
YCN8-3004	CLEARVIEW MEALMASTER® SMALL CHICKEN BARN™ CONTAINER	D7
YCN8-3008Z	CLEARVIEW MEALMASTER® MED. CHICKEN BARN CONTAINER WZIPSEAL™	D7
YCN8-6003DZ	X-LARGE ROASTER BASE W/DOME LID W/FOG GARD - WZIPSEAL™	D7
YCN8-6007DZ	MED. ROASTER BASE W/DOME W/FOG GARD™ COATING	D7
YCN8-6007DPPZ	MED. ROASTER W/VENT DRY ZIP SEAL™ PP DOME	D7
YCN8-6008DZ	MED. TO LG. ROASTER BASE W/DOME W/FOG GARD™ COATING - WZIPSEAL™	D7
YCN8-6011D	SMALL ROASTER BASE W/DOME LID W/FOG GARD™ COATING	D7
YCN8-6907DZ	HANDLED CHICKEN ROASTER CONTAINER W/FOG GARD™ DOME	D7
YEH8-7024	CLEARVIEW™ ROSEWARE™ 24 OZ. BOWL	D13
YEH8-7035	CLEARVIEW™ ROSEWARE™ 35 OZ. BOWL	D13
YL2508	8 OZ NEWSPRING DELTAINER® CLEAR DELI CONTAINER & LID	D19
YL2508-B	8 OZ NEWSPRING DELTAINER® BLACK DELI CONTAINER & LID	D19
YL2512	12 OZ NEWSPRING DELTAINER® CLEAR DELI CONTAINER & LID	D19

Product Number	Description	Page
YL2512-B	12 OZ NEWSRING DELITAINER® BLACK DELI CONTAINER & LID.....	D19
YL2520	20 OZ NEWSRING DELITAINER® CLEAR DELI CONTAINER & LID.....	D19
YL2524	24 OZ NEWSRING DELITAINER® CLEAR DELI CONTAINER & LID.....	D19
YLI811200000	EARTHCHOICE® PLA MEDIUM 1-CMPT. HINGED LID CONTAINER.....	D15
YLI811230000	EARTHCHOICE® PLA MEDIUM 3-CMPT. HINGED LID CONTAINER.....	D15
YLI811600000	6" EARTHCHOICE® PLA CLEAR HINGED LID CONTAINER .....	D15
YLI860080000	8 OZ. EARTHCHOICE® PLA CLEAR DELI CONTAINER W/LID.....	D15
YLI860160000	16 OZ. EARTHCHOICE® PLA CLEAR DELI CONTAINER W/LID.....	D15
YLI860240000	24 OZ. EARTHCHOICE® PLA CLEAR DELI CONTAINER W/LID.....	D15
YLI860320000	32 OZ. EARTHCHOICE® PLA CLEAR DELI CONTAINER W/LID.....	D15
YNL500	NEWSRING DELITAINER® RECESSED LID FOR 8-32 CONTAINERS .....	D19
YP9197	FLAT LID FOR 9197, 9198.....	D13
YP92008HU	DOME LID FOR 92008, 92012, 92016, 92016K, 92025 .....	D13
YP92025HU	DOME LID FOR 92025, 92032, 92032K, 92048, 92064 .....	D13
YP92025S	FLAT LID FOR 92025, 92032, 92032K, 92048, 92064.....	D13
YP95105	CLEARVIEW™ CLEAR PORTION PLATTER DOME.....	D15
YP95107	CLEARVIEW™ CLEAR SHALLOW MEDIUM PLATTER DOME.....	D15
YP95108	CLEARVIEW™ CLEAR DEEP ENTREE PLATTER DOME.....	D15
YP95109	CLEARVIEW™ CLEAR DEEP MEDIUM PLATTER DOME .....	D15
YSD2516	16 OZ NEWSRING DELITAINER® CLEAR DELI CONTAINER BULK PACK.....	D19
YSD2532	32 OZ NEWSRING DELITAINER® CLEAR DELI CONTAINER & LID .....	D19
YSD2532B	32 OZ NEWSRING DELITAINER® BLACK DELI CONTAINER & LID.....	D19

Product Number	Description	Page
----------------	-------------	------



## Aluminum Carry-Out — Window-Pack® and Thrift-Pack® Combos

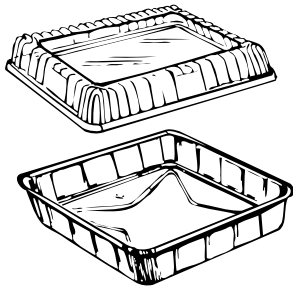

664WP

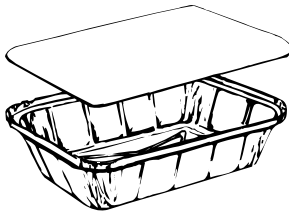

788TP

## Aluminum Classic Carry-Out™ Packaging

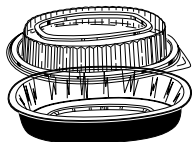

6707WPSFG

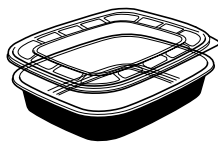

6708WPZFG

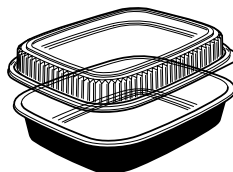

Y6710WPSFG

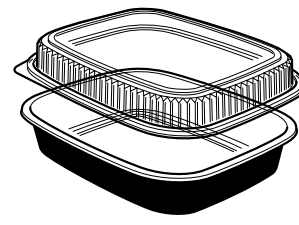

6711WP

## Nutrition Products

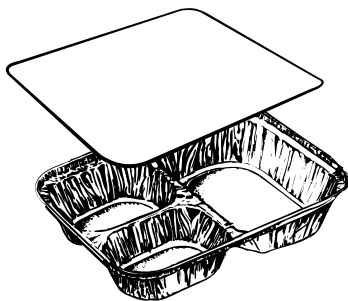

Y7139TP

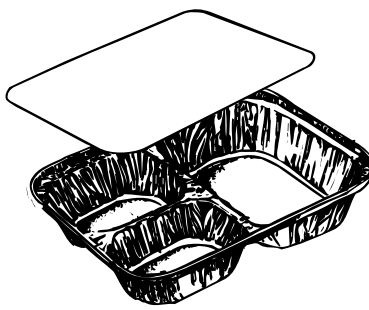

Y7239TP

## Aluminum Carry-Out — Window-Pack® and Thrift-Pack® Combos

Product Number	Container Description	Capacity (fl. oz.)	Dimensions (in inches)	Cover Description	Case Cube	Case Weight	Case Pack
664WP	8" Square Cake Pan (664)	32.0	7 7/8 x 7 7/8 x 1 5/16	w/ Plastic Dome (P664)	2.02	9.00	100
69310TP	10" 3-Cmpt. Oblong Tray (69310)	--	10 x 9 1/4 x 1 5/8	Foil Laminated Board Cover (L69310)	4.06	30.00	250
788TP*	Carry-Out Oblong Tray (788)	36.0	8 1/2 x 6 x 1 3/4	Foil Laminated Board Cover (L788)	1.40	14.50	250

## Aluminum Classic Carry-Out™ Packaging

Product Number	Description	Capacity (fl. oz.)	Dimensions (in inches)			Vert. Depth	Case Cube	Case Weight	Case Pack	Cases/ Unit Load
			Top Out	Top In	Bottom					
6707WPSFG	16 oz. Oval Foil Base w/Dome Lid w/Fog-Gard™ Coating	Base: 16.0 Lid:	7 9/16 x 5 1/4	6 7/8 x 4 9/16	6 35/64 x 4 15/64	1 5/16	1.09	7.82	100	
6708WPZFG	Single Serve Black/Gold Foil Base w/Flat Lid w/Fog-Gard Coating	Base: 22.0 Lid:	8 3/16 x 6 3/16	7 1/2 x 5 1/2	7 3/16 x 5 3/16	1 1/4 27/64	1.37	8.02	100	
6708WPSFG	Single Serve Black/Gold Foil Base w/Dome w/Fog-Gard Coating	Base: 22.0 Dome:	8 3/16 x 6 3/16	7 1/2 x 5 1/2	7 3/16 x 5 3/16	1 1/4 1 3/16	1.37	8.12	100	
Y6710WPZFG	Small Black/Gold Foil Base w/Flat Lid w/Fog-Gard Coating	Base: 46.0 Lid:	9 3/4 x 7 3/4	9 x 7	8 9/16 x 6 9/16	1 3/4 7/16	1.12	6.53	50	50
Y6710WPSFG	Small Black/Gold Foil Base w/Dome w/Fog-Gard Coating	Base: 46.0 Dome:	9 3/4 x 7 3/4	9 x 7	8 9/16 x 6 9/16 1 3/16	1 3/4	1.12	6.53	50	50
6711WP	Large Blk/Gold Foil Base w/Dome	Base: 60.0 Dome:	11 1/4 x 8 7/8	10 7/16 x 8 1/16	10 x 7 5/8	1 3/4	1.45	10.23	50	
			11 17/32 x 9 9/32	9 29/32 x 7 17/32	9 23/32 x 7 11/32	1 7/32				

Classic Carry-Out™ containers are microwaveable under the proper conditions: the container must not touch the side walls of the microwave; it must not be covered with aluminum foil; it must be at least 2/3 full of food. Do not use in ovens manufactured pre-1980. See pages 61-63 for other Pactiv dual-ovenable products.

## Nutrition Products

Product Number	Description	Capacity (fl. oz.)	Dimensions (in inches)			Vert. Depth	Rim Style	Case Cube	Case Weight	Case Pack	Cases/ Unit Load
			Top Out	Top In	Bottom						
Y7139TP	3-Cmpt. Sr. Citizen Hi-Divider Oblong Tray (7139) w/ Foil Laminated Board Cover (L739)	13.0/5.5/5.5	8 1/2 x 6 1/2	8 x 5 7/8	7 1/4 x 5 1/8	1 1/2	I.V.C.	1.28	14.12	200	45
Y7139TPP	3-Cmpt. Sr. Citizen Hi-Divider Oblong Tray (7139) w/ Ovenable Paper Cover (L739P)	13.0/5.5/5.5	8 1/2 x 6 1/2	8 x 5 7/8	7 1/4 x 5 1/8	1 1/2	I.V.C.	1.28	14.12	200	45
7239TP	3-Cmpt. Hi-Divider Hemmed Edge Oblong Tray (7239) w/ Foil Laminated Board Cover (L739)	13.0/5.5/5.5	8 1/2 x 6 1/2	8 x 5 7/8	7 1/4 x 5 1/8	1 1/2	H.E.	3.25	18.00	250	
7089TP	4-Cmpt. Sr. Citizen Oblong Tray (7089) w/ Foil Laminated Board Cover (L7089)	10.0/4.2/4.0/4.0	9 x 7	8 1/2 x 6 1/2	7 3/4 x 5 3/4	1 13/32	I.V.C.	2.40	20.00	250	

7089TP is produced under the following patent: D280,060

**School Feeding Containers / Compartmented Foil Trays**

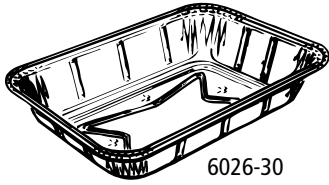

6026-30

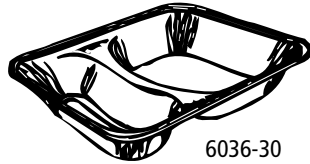

6036-30

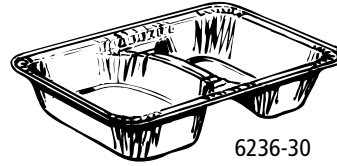

6236-30

**Hefty® Fast-Pak® Pre-Portioned Utility Bags**



SR1-0708

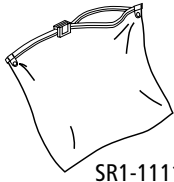

SR1-1111

**QUIK-SEAL™ Reclosable Bags**

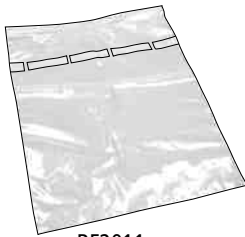

RF2011



RQ78



RS78



RT1014



RS68

**ClearView™ Micromax® Containers — Clear Lids/Domes, Black Bases**



CN8-5100

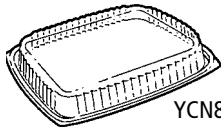

YCN8-5101D



CN8-5200

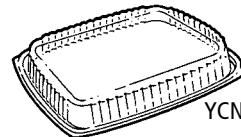

YCN8-5201D



CN8-5008

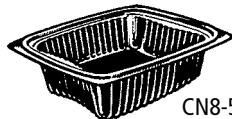

CN8-5012

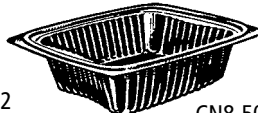

CN8-5016

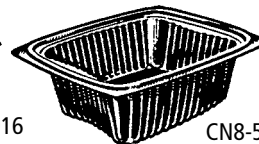

CN8-5024

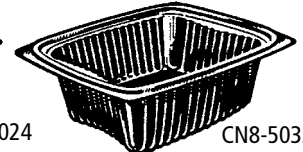

CN8-5032



YCI8-5300

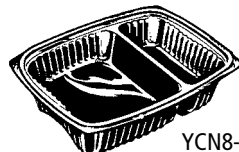

YCN8-5420

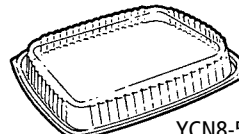

YCN8-5301D

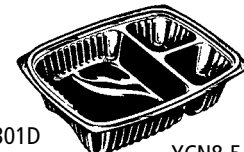

YCN8-5430



### School Feeding Containers / Compartmented Foil Trays

Product Number	Description	Capacity (fl. oz.)	Top Out	Dimensions (in inches)		Vert. Depth	Case Cube	Case Weight	Case Pack
				Top In	Bottom				
6026-30	1 lb. Shallow Oblong Pan	14.0	6 1/2 x 5	6 x 4 1/2	5 x 3 1/2	1 17/64	2.94	19.57	1000
6036-30	2-Cmpt. Oblong Hamburger Pan	5.9/3.4	6 1/2 x 5	6 x 4 1/2	5 x 3 1/2	1 17/64	2.94	21.68	1000
6326-30	Deep Oblong Pan	17.7	6 1/2 x 5	6 1/32 x 4 17/32	5 11/32 x 3 27/32	1 7/16	2.94	23.22	1000
6236-30	2-Cmpt. Oblong Deep Hamburger Pan	8.0/3.8	6 1/2 x 5	6 x 4 1/2	5 5/16 x 3 13/16	1 33/64	2.94	24.70	1000
69107-30	2-Cmpt. Oblong Deep Hot Dog Pan	9.3/6.0	6 1/2 x 5	6 x 4 1/2	5 3/8 x 3 7/8	1 3/8	3.09	27.71	1000

### Hefty® Fast-Pak® Pre-Portioned Utility Bags

Product Number	Description	Dimensions (in inches)	Case Count	Cases Per Skid	Cube	Case Ship Wt. (lbs.)
SR1-0708	Quart-size utility bag	8" x 7"	750 (3 packs of 250)	40	3.62	10.80
SR1-1111	Gallon-size utility bag	10 1/2" x 11"	250	102	0.50	5.77

### QWIK-SEAL™ & QWIK-SLIDE™ Reclosable Bags

Product Number	Description	Dimensions (in inches)	Case Count	Cases Per Skid	Cube	Case Ship Wt. (lbs.)
<b>QWIK-SEAL™ Reclosable Freezer Bags</b>						
RF1011	One gallon freezer bags	10 9/16 x 10 3/4	200	204	0.24	5.80
RF2011	Two gallon freezer bags	15 5/8 x 13	100	243	0.20	4.70
<b>QWIK-SLIDE™ Reclosable Food Storage Bags</b>						
RQ1011	Gallon bags	10 7/16 x 11	250	112	0.43	5.20
RQ78	Quart bags	7 x 8	250	140	0.15	3.10
<b>QWIK-SEAL™ Reclosable Food Storage Bags</b>						
RS1011	Reclosable one gallon bags	10 9/16 x 10 3/4	250	204	0.24	5.10
RS2011	Recloseable two gallon bags	15 11/16 x 13	100	216	0.20	4.00
RS63	Recloseable portion bags	6 1/2 x 3 1/4	500	294	0.17	2.90
RS65	Recloseable sandwich bags	6 5/8 x 5 7/8	500	252	0.19	4.20
RS78	Recloseable quart bags	7 x 7 3/4	500	180	0.28	5.40
RT1014	Utility bags w/ties	10 x 14	500	288	0.17	5.00
RT1824	Trayed foods w/ties	18 x 24	250	196	0.24	8.50
RT2735	Bun tray covers w/ties	27 x 35	200	120		14.00
RF68	Fold and Close sandwich bags	6 1/2 x 8	2,000	185		5.30

### ClearView™ Micromax® Containers — Clear Lids/Domes, Black Bases

Product Number	Description	Capacity (fl. oz.)	Dimensions	Cube	Case Approx. Wt.	Packing Sleeve	Case	Cases/ Unit Load
CN8-5008	8 oz. Black Tray (TFPP)	8 oz.	5 7/8 x 4 7/8 x 1 1/4	1.51	5.64	4/63	252	
CN8-5012	12 oz. Black Tray (TFPP)	12 oz.	5 15/16 x 4 15/16 x 2 1/16	1.66	18.84	4/63	252	
CN8-5016	16 oz. Black Tray (TFPP)	16 oz.	7 1/2 x 6 7/16 x 1 1/2	2.41	12.46	4/63	252	
CN8-5024	24 oz. Black Tray (TFPP)	24 oz.	7 1/2 x 6 7/16 x 1 15/16	2.47	12.42	4/63	252	
CN8-5032	32 oz. Black Tray (TFPP)	32 oz.	7 1/2 x 6 7/16 x 2 1/4	2.47	13.57	4/63	252	
YCN8-5420	Black 2-Cmpt. Oblong Tray (TFPP)	9 oz.(S) - 20 oz.(L)	9 x 7 3/8 x 1 7/8	3.25	17.78	4/55	220	
YCN8-5430	Black 3-Cmpt. Oblong Tray (TFPP)	4 oz.(S) - 20 oz.(L)	9 x 7 3/8 x 1 7/8	3.28	17.78	4/55	220	
CN8-5100	Clear Snap-on Lid for 8 & 12 oz. Trays	--	5 29/32 x 4 29/32	0.99	3.50	4/63	252	
YCN8-5101D	Clear Snap-on Dome Lid for 8 & 12 oz. Trays w/Fog Gard™ Coating	--	5 29/32 x 4 29/32 x 1	0.82	4.35	4/63	252	70
CN8-5200	Clear Snap-on Lid for 16, 24 & 32 oz. Trays	--	7 1/2 x 6 1/2	1.41	6.48	4/63	252	
YCN8-5201D	Clear Snap-on Dome Lid for 16, 24, & 32 oz. Trays w/Fog Gard Coating	--	7 1/2 x 6 1/2 x 1	1.25	7.12	4/63	252	45
YCI8-5300	Clear Snap-on Lid for 2 & 3 Cmpt. Trays	--	9 x 7 13/32	1.71	7.50	4/55	220	30
YCN8-5301D	Clear Snap-on Dome Lid for 2 & 3 Cmpt. Trays w/Fog Gard Coating	--	9 x 7 13/32 x 1	1.95	8.42	4/55	220	24

D = Dry Antifog Fog Gard™ (NEW), Z = Zip Seal™, Y = Perfect Cube

**ClearView™ Micromax® Oval Containers — Clear Lids, Black Bases**

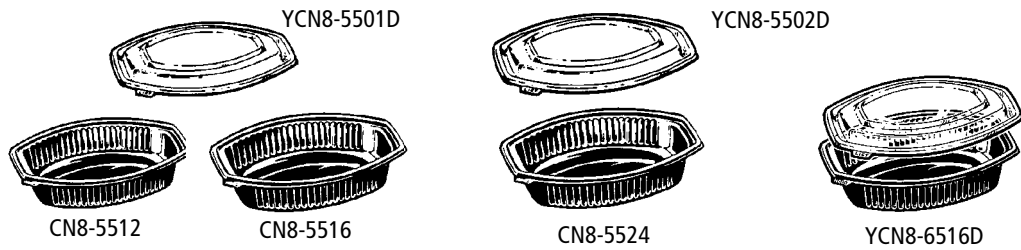

**ClearView™ MealMaster® Rib Containers w/Fog Gard™ Coating**

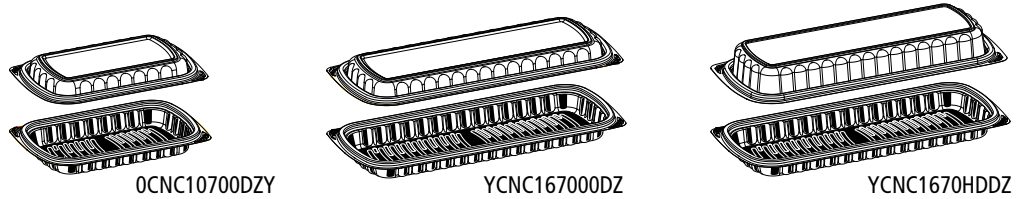

**ClearView™ MealMaster® Roaster Containers w/Fog Gard™ Coating — Clear Lids/Domes, Black Bases**

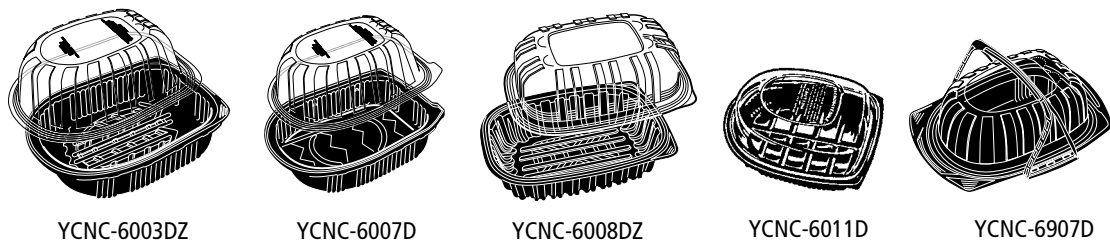

**ClearView™ MealMaster® Chicken Barn™ Containers w/SmartTote™ Handles**

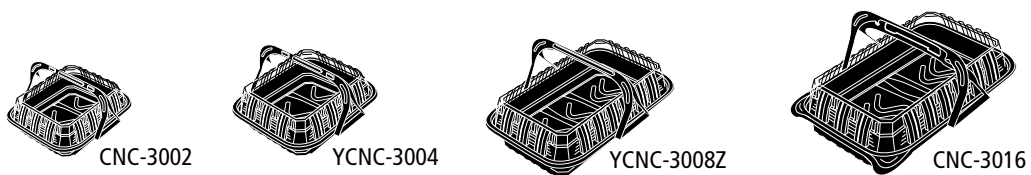

**ClearView™ MealMaster® HMR Containers w/Fog Gard Coating — Small**

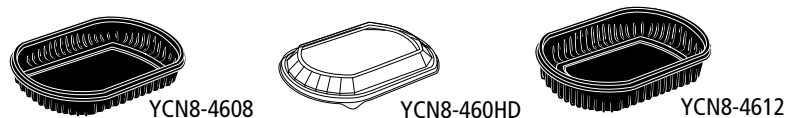

### ClearView™ Micromax® Oval Containers — Clear Lids, Black Bases

Product Number	Description	Capacity (fl. oz.)	Dimension	Cube	Case Approx. Wt.	Packing Sleeve	Case	Cases/ Unit Load
CN8-5512	12 oz. Black Oval Casserole (TFPP)	12 oz.	7 <sup>7</sup> / <sub>8</sub> x 5 <sup>1</sup> / <sub>4</sub> x 2 <sup>1</sup> / <sub>4</sub>	1.82	7.75	4/63	250	
CN8-5516	16 oz. Black Oval Casserole (TFPP)	16 oz.	7 <sup>7</sup> / <sub>8</sub> x 5 <sup>1</sup> / <sub>4</sub> x 2 <sup>1</sup> / <sub>2</sub>	1.82	7.75	4/63	250	
CN8-5524	24 oz. Black Oval Casserole (TFPP)	24 oz.	8 <sup>3</sup> / <sub>8</sub> x 6 x 2 <sup>1</sup> / <sub>2</sub>	2.27	10.58	4/63	250	
YCN8-5501D	Clear Dome Snap-on Lid for 12 & 16 oz. Oval Casseroles w/Fog Gard™ Coating	--	7 <sup>7</sup> / <sub>8</sub> x 5 <sup>1</sup> / <sub>4</sub> x <sup>1</sup> / <sub>4</sub>	1.73	6.64	4/63	252	27
YCN8-5502D	Clear Dome Snap-on Lid for 24 oz. Oval Casserole w/Fog Gard™ Coating	--	8 <sup>3</sup> / <sub>8</sub> x 6 x <sup>1</sup> / <sub>4</sub>	2.23	7.49	4/63	252	24
YCN8-6516D	16 oz. Black Oval Casserole (TFPP) and Lid w/Fog Gard™ Coating	16oz.	7 <sup>7</sup> / <sub>8</sub> x 5 <sup>1</sup> / <sub>4</sub> x 2 <sup>3</sup> / <sub>4</sub>	3.19	14.63	4/63 ea.	252 ea.	18

### ClearView™ MealMaster® Rib Containers w/Fog Gard™ Coating

Product Number	Description	Dimensions (in inches)	Cube	Case Approx. Wt.	Packing Sleeve	Case	Cases/ Unit Load
0CNC10700DZY	Half Slab Rib Combo ZipSeal™ w/ Fog Gard™ Coating	10.01 x 7.09 x 2.12	2.48	10.68	2/45 ea.	90 ea.	22
YCNC167000DZ	Full Slab Rib Combo ZipSeal™ w/ Fog Gard™ Coating	16 <sup>5</sup> / <sub>8</sub> x 7 <sup>5</sup> / <sub>16</sub> x 2 <sup>1</sup> / <sub>4</sub>	3.06	14.05	2/40 ea.	80 ea.	18
YCN1670HDDZ	Full Slab Rib Combo w/Deep Dome ZipSeal™ w/ Fog Gard™	16 <sup>5</sup> / <sub>8</sub> x 7 <sup>5</sup> / <sub>16</sub> x 2 <sup>1</sup> / <sub>4</sub>	3.06	14.05	2/40 ea.	80 ea.	18

### ClearView™ MealMaster® Roaster Containers w/Fog Gard™ Coating — Clear Lids/Domes, Black Bases

Product Number	Description	Capacity (fl. oz.)	Dimensions (in inches)	Cube	Case Approx. Wt.	Packing Sleeve	Case	Cases/ Unit Load
YCNC-6003DZ	X-Large Roaster Base w/Dome Lid w/Fog Gard™ Coating - with ZipSeal™	50.0	10 <sup>3</sup> / <sub>4</sub> x 8 <sup>1</sup> / <sub>2</sub> x 4 <sup>1</sup> / <sub>4</sub>	2.26	14.03	1/95 ea.	95 ea.	24
YCNC-6007D	Medium Roaster Base w/Dome Lid w/Fog Gard™ Coating	32.0	10 <sup>3</sup> / <sub>8</sub> x 7 <sup>7</sup> / <sub>8</sub> x 4	2.04	12.83	1/100 ea.	100 ea.	24
YCNC-6008DZ	Medium to Large Roaster Base w/Dome Lid w/Fog Gard™ Coating - with ZipSeal™	50.0	10 x 7.7 x 4 <sup>1</sup> / <sub>2</sub>	2.02	13.46	1/100 ea.	100 ea.	30
YCNC-6011D	Small Roaster Base w/Dome Lid w/Fog Gard™ Coating	24.3	9 <sup>5</sup> / <sub>8</sub> x 7 x 3 <sup>1</sup> / <sub>2</sub>	1.58	8.62	1/80 ea.	80 ea.	24
YCNC-6907D	Handled Chicken Roaster Container w/Dome Lid w/Fog Gard™ Coating	32.0	11 <sup>1</sup> / <sub>4</sub> x 8.6 x 4 <sup>1</sup> / <sub>4</sub>	2.95	20.62	1/120 ea.	120 ea.	18
YCNC6007DPPZ	Med. Chicken Roaster Vent Dry ZipSeal™/Fog Gard™	32.00	10 x 7 <sup>1</sup> / <sub>2</sub> x 4	2.29	12.03	2/95 ea.	190 ea.	24

### ClearView™ MealMaster® Chicken Barn™ Containers w/SmartTote™ Handles

Product Number	Description	Dimensions (in inches)	Case Cube	Case Weight	Sleeve	Case Pack	Cases/ Unit Load
CNC-3002	Small MealMaster® Chicken Barn™ Container w/Dome (2 pc.)		2.36	14.66	1/200 ea.	200 ea.	12
YCNC-3004	Small MealMaster® Chicken Barn™ Container w/Dome (4 pc.)	9 <sup>1</sup> / <sub>2</sub> x 8 x 3	2.15	11.75	1/100 ea.	100 ea.	24
YCNC-3008Z	Medium MealMaster® Chicken Barn™ Container w/Dome - with ZipSeal™ (8 pc.)	13 <sup>3</sup> / <sub>10</sub> x 8 <sup>2</sup> / <sub>5</sub> x 4	3.33	19.77	1/105 ea.	105 ea.	18
CNC-3016	Large Small MealMaster® Chicken Barn™ Container w/Dome (16 pc.)	14 x 10 <sup>1</sup> / <sub>2</sub> x 4	2.56	14.77	1/50 ea.	50 ea.	18

D = Dry Antifog Fog Gard™ (NEW), Z = Zip Seal™, Y = Perfect Cube

### ClearView™ MealMaster® HMR Containers w/Fog Gard Coating — Small

Product Number	Description	Capacity (fl. oz.)	Dimensions (In Inches) Top Out	Cube	Case Approx. Wt.	Packing Sleeve	Case	Cases/ Unit Load
YCN8-4608	Small Black Tray	8 oz.	6 <sup>1</sup> / <sub>8</sub> x 4 <sup>7</sup> / <sub>8</sub> x 1 <sup>1</sup> / <sub>8</sub>	1.35	12.01	4/58	232	
YCN8-4612	Small Black Tray	12 oz.	6 <sup>1</sup> / <sub>8</sub> x 4 <sup>7</sup> / <sub>8</sub> x 1 <sup>5</sup> / <sub>8</sub>	1.35	9.72	4/58	232	
YCN8-460HD	Small Dome Lid w/Fog Gard™ Coating	--	6 <sup>1</sup> / <sub>8</sub> x 4 <sup>7</sup> / <sub>8</sub> x 1	1.06	4.74	4/58	232	24

**ClearView™ MealMaster™ HMR Containers w/Fog Gard™ Coating — Medium**

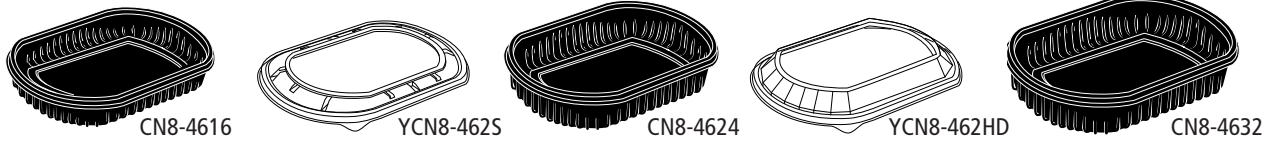

**ClearView™ MealMaster® HMR Containers w/Fog Gard™ Coating — Large**

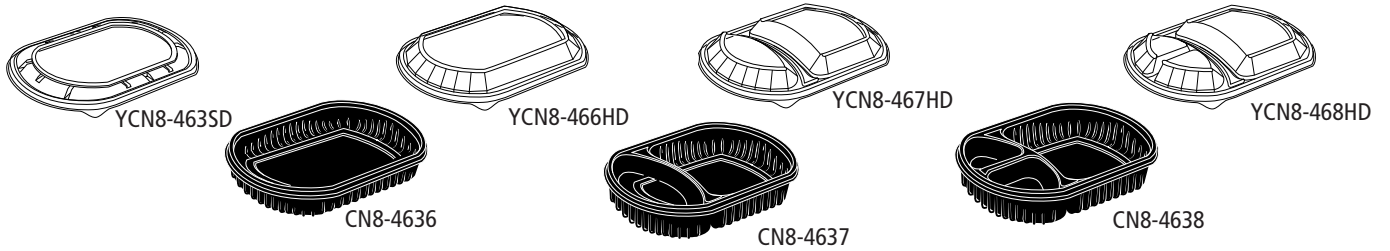

**Pressware® Classic Stoneware™ Dual-Ovenable Paperboard Trays – White w/Brown Specks**

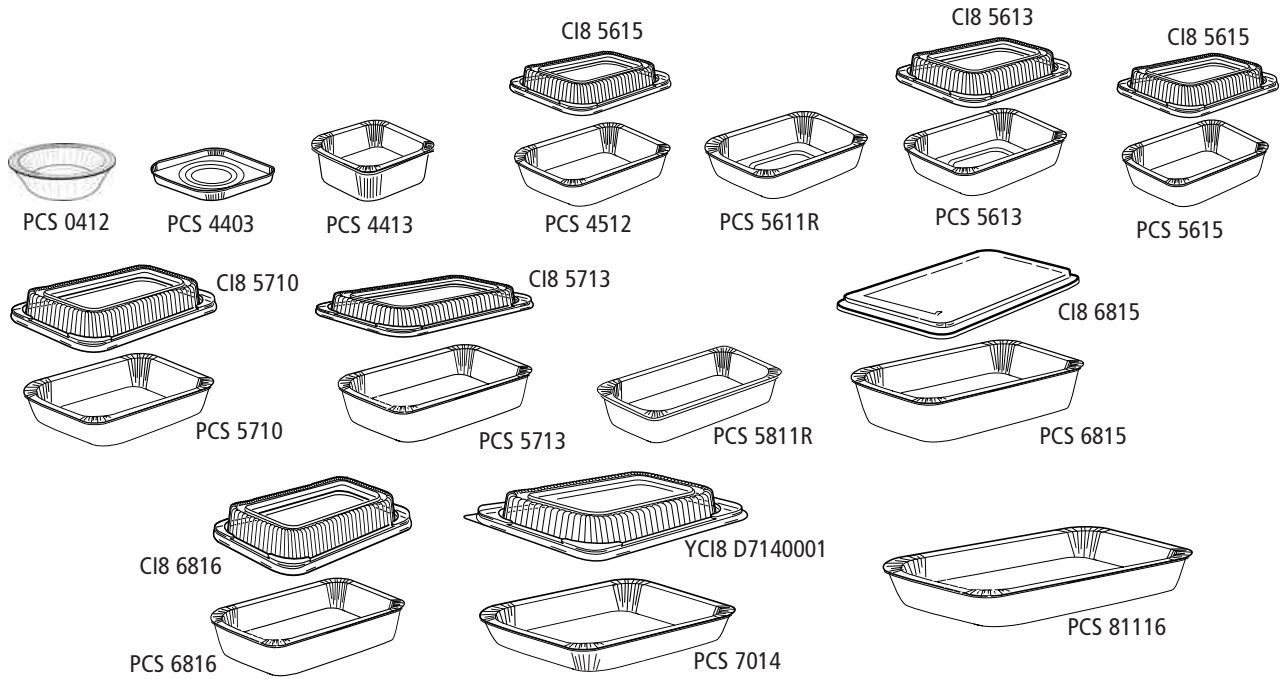

**Pressware® Dual-Ovenable Paperboard Deli Trays & Domes**

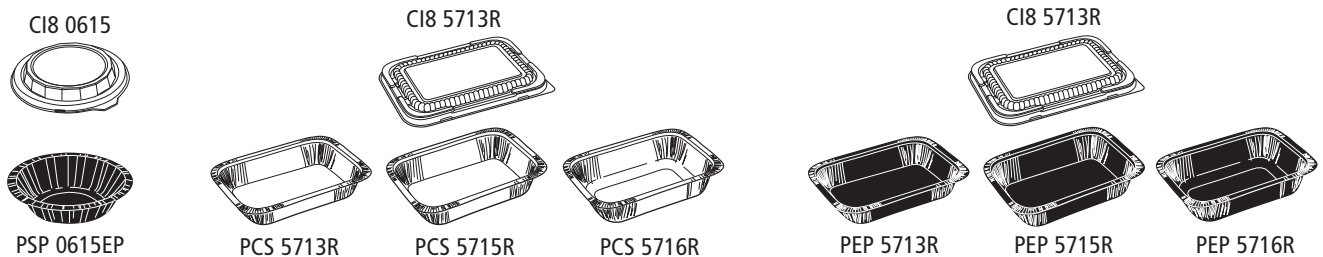

**ClearView™ MealMaster™ HMR Containers w/Fog Gard™ Coating — Medium**

Product Number	Description	Capacity (fl. oz.)	Dimensions (In Inches) Top Out	Cube	Case Approx Wt.	Packing Sleeve	Case	Cases/ Unit Load
CN8-4616	Medium Black Tray	16 oz.	8 1/8 x 6 1/2 x 1	2.39	11.70	4/63	252	
CN8-4624	Medium Black Tray	24 oz.	8 1/8 x 6 1/2 x 1 1/2	2.39	12.89	4/63	252	
CN8-4632	Medium Black Tray	32 oz.	8 1/8 x 6 1/2 x 2	2.39	12.89	4/63	252	
YCN8-4625	Medium Flat Lid w/Fog Gard™ Coating	--	8 1/8 x 6 1/2 x 3/8	2.39	10.00	4/63	252	
YCN8-462HD	Medium Dome Lid w/Fog Gard™ Coating	--	8 1/8 x 6 1/2 x 1	2.39	8.00	4/63	252	
YCN8462500D0	Medium Flat Lid w/Fog Gard™ Coating	--	8 1/8 x 6 1/2 x 3/8	1.99	7.82	6/42	252	30
YCN8462H00D0	Medium Dome Lid w/Fog Gard™ Coating	--	8 1/8 x 6 1/2 x 1	2.31	7.86	6/42	252	24

**ClearView™ MealMaster® HMR Containers w/Fog Gard™ Coating — Large**

Product Number	Description	Capacity (fl. oz.)	Dimensions (In Inches) Top Out	Cube	Case Approx Wt.	Packing Sleeve	Case	Cases/ Unit Load
CN8-4636	Large Black 1-Compartment Tray	36 oz.	9 3/8 x 8 x 1 1/2	3.22	16.50	4/63	252	
CN8-4637	Large Black 2-Compartment Tray	21 oz., 10 oz.	9 3/8 x 8 x 1 1/2	3.22	16.50	4/63	252	
CN8-4638	Large Black 3-Compartment Tray	21 oz., 4.5 oz., 4.5 oz.	9 3/8 x 8 x 1 1/2	3.22	16.50	4/63	252	
CN8-4635D	Large Flat Lid w/Fog Gard™	--	9 3/8 x 8 x 3/8	3.22	10.85	4/63	252	
CN8-466HD	Large 1-Compartment Dome Lid w/Fog Gard™	--	9 3/8 x 8 x 1 1/4	3.22	11.04	4/63	252	
CN8-467HD	Large 2-Compartment Dome Lid w/Fog Gard™	--	9 3/8 x 8 x 1 1/4	3.22	11.04	4/63	252	
CN8-468HD	Large 3-Compartment Dome Lid w/Fog Gard™	--	9 3/8 x 8 x 1 1/4	3.22	11.04	4/63	252	
YCN8463500D0	Large Flat Lid w/Fog Gard™	--	9 3/8 x 8 x 1 3/8	3.14	11.65	4/63	252	18
YCN8466H00D0	Large Dome Lid w/Fog Gard™	--	9 3/8 x 8 x 1 1/4	2.37	11.34	4/63	252	24
YCN8467H00D0	Large 2-Compartment Dome Lid w/Fog Gard™	--	9 3/8 x 8 x 1 1/4	3.14	11.65	4/63	252	18
YCN8468H00D0	Large 3-Compartment Dome Lid w/Fog Gard™	--	9 3/8 x 8 x 1 1/4	3.14	12.79	4/63	252	18

**Pressware® Classic Stoneware™ Dual-Ovenable Paperboard Trays – White w/Brown Specks**

Product Number	Description	Capacity (fl. oz.)	Top Out	Dimensions (in inches) Top In	Bottom	Vert. Depth	Cube	Case Approx. Wt.	Case Pack
PCS 0412	Round Tray	5.70	4 3/16	3 11/16	2 13/16	1 1/4	1.32	17.85	1000
PCS 4403	Square Tray (uncoated)	3.50	4 5/16 x 4 5/16	4 5/16 x 4 5/16	4 1/32 x 4 1/32	3/8	2.45	29.98	3000
PCS 4412	Square Tray	5.80	4 3/16 x 4 3/16	3 11/16 x 3 11/16	2 11/16 x 2 11/16	1 1/4	1.91	29.94	1500
PCS 4413	Square Tray	9.50	4 5/8 x 4 5/8	4 1/8 x 4 1/8	3 3/32 x 3 3/32	1 3/8	1.63	24.90	1000
PCS 4512	Oblong Tray	13.0	4 7/8 x 5 15/16	4 3/8 x 5 7/16	3 17/32 x 4 9/16	1 1/4	2.17	28.21	1000
PCS 5611R	Oblong Tray (rounded corners)	13.8	4 29/32 x 6 17/32	4 13/32 x 6 1/32	3 25/32 x 5 9/32	1 1/8	3.05	30.40	1000
PCS 5613	Oblong Tray	14.5	4 31/32 x 6 9/16	4 15/32 x 6 1/16	3 7/16 x 4 15/16	1 3/8	3.05	35.47	1000
C18 5613	Oblong Dome Lid for 5613	--	5 7/32 x 6 13/16	--	--	7/8	4.82	13.00	1000
PCS 5613RR1	Oblong Tray (rounded corners)	14.5	4 27/32 x 6 17/32	4 11/32 x 6 1/32	3 1/2 x 5	1 3/8	1.47	17.04	500
C18 5613R	Obong Dome Lid for 5613R	--	5 3/32 x 6 25/32	--	--	7/8	5.41	15.00	1000
PCS 5615	Oblong Tray	16.8	4 29/32 x 6 3/32	4 13/32 x 5 19/32	3 3/16 x 4 5/16	1 11/16	1.63	18.21	500
C18 5615	Oblong Dome Lid for 4512 & 5615	--	5 5/32 x 6 11/32	--	--	1/2	3.36	13.00	1000
PCS 5710	Oblong Tray	15.4	5 1/16 x 7 13/16	4 9/16 x 7 5/16	4 1/16 x 6 11/16	1	2.18	17.22	500
C18 5710	High Dome Lid for 5710 & 5713	--	5 5/16 x 8 1/16	--	--	1 1/8	2.92	11.00	500
PCS 5713	Oblong Tray	20.8	5 1/16 x 7 25/32	4 9/16 x 7 9/32	3 5/8 x 6 5/16	1 3/8	1.30	11.17	250
C18 5713	Low Dome Lid for 5710 & 5713	--	5 5/16 x 8 1/32	--	--	1/2	1.18	6.00	250
PCS 5811R	Oblong Tray (rounded corners)	20.5	5 29/32 x 8 9/32	5 13/32 x 7 25/32	4 25/32 x 7	1 1/8	2.41	24.99	500
PCS 6815	Oblong Tray	36.7	6 19/32 x 8 3/4	6 3/32 x 8 1/4	5 1/8 x 7 1/16	1 5/8	1.74	16.75	250
C18 6815	Oblong Dome Lid for 6815	--	6 31/32 x 9 1/8	--	--	1/4	2.22	12.00	250
PCS 6816	Oblong Tray	32.0	6 x 7 7/8	5 1/2 x 7 3/8	4 1/4 x 6 1/8	1 3/4	2.36	27.01	500
C18 6816Y	Obong Dome Lid for 6816	--	6 1/4 x 8 1/8	--	--	3/8	2.91	12.00	500
PCS 7014	Oblong Tray	45.0	7 15/32 x 9 31/32	6 31/32 x 9 15/32	6 x 8 5/16	1 1/2	2.05	21.08	250
YCI8 D7140001	Obong Dome Lid for 7014	--	7 23/32 x 10 7/32	--	--	3/4	2.55	11.00	280
PCS 81116	Oblong Tray	64.3	8 9/16 x 11 31/32	8 1/16 x 11 15/32	6 3/8 x 9 5/8	1 3/4	3.93	29.08	250

Do Not Place Dome Lids In Conventional or Microwave Ovens. Do Not Use PRESSWARE® Containers In Toaster Ovens.

**Pressware® Dual-Ovenable Paperboard Deli Trays & Domes**

Product Number	Description	Capacity (fl. oz.)	Dimensions (In Inches)	Cube	Case Approx Wt.	Case Pack
PSP 0615EP	Ebony Premier Black Round Deli Bowl	16.5	6 11/32 x 1 5/8	1.60	19.80	500
PCS 5713R	Classic Stoneware Shallow Oblong Deli Tray	21.3	5 7/16 x 7 7/16 x 1 3/8	2.30	22.10	500
PCS 5715R	Classic Stoneware Oblong Deli Tray	23.0	5 3/8 x 7 3/8 x 1 3/4	2.53	22.71	500
PCS 5716R	Classic Stoneware Deep Oblong Deli Tray	25.0	5 7/16 x 7 7/16 x 1 3/4	1.50	13.70	250
PEP 5713R	Ebony Premier Black Shallow Oblong Deli Tray	21.3	5 7/16 x 7 7/16 x 1 3/8	2.30	22.70	500
PEP 5715R	Ebony Premier Black Oblong Deli Tray	23.0	5 3/8 x 7 3/8 x 1 3/4	2.53	22.71	500
PEP 5716R	Ebony Premier Black Deep Oblong Deli Tray	25.0	5 7/16 x 7 7/16 x 1 3/4	1.50	14.10	250
C18 0615	Clear Dome Lid for 0615 Round Bowl	--	--	3.10	13.40	500
C18 5713R	Clear Dome Lid for 5713R/5716R Oblong Trays	--	--	2.20	10.00	500

## Pressware® Ebony Premier® Dual-Ovenable Paperboard Trays

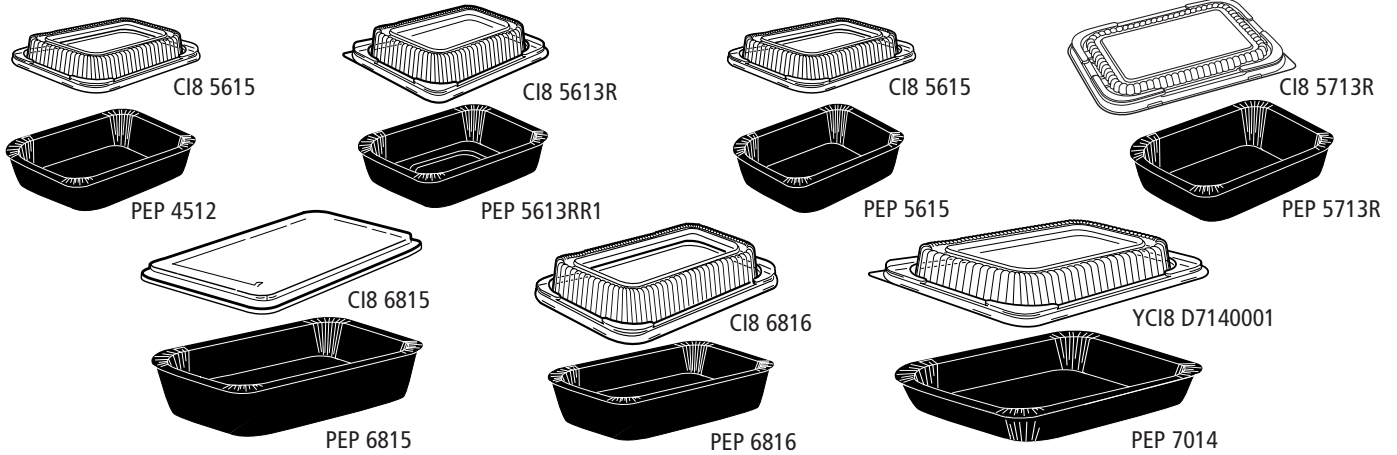

## Clear OPS Dome Lids for Pressware® Trays

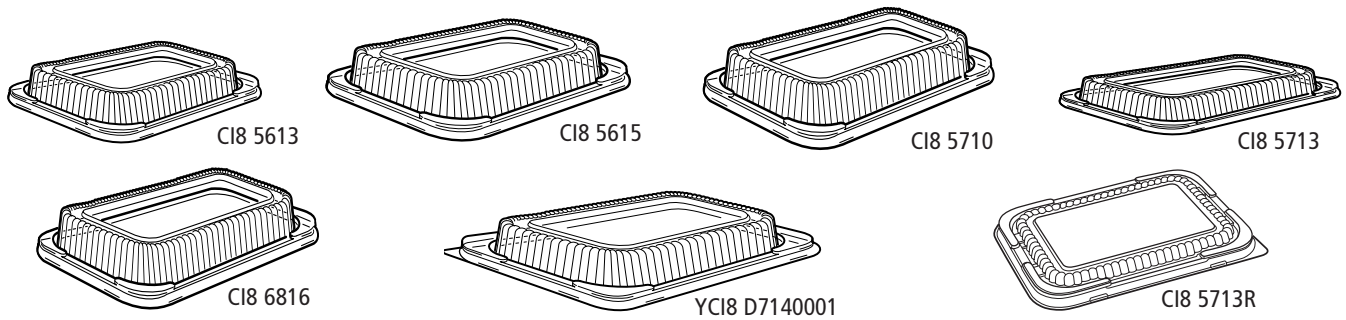

## The Sell Out® Hingeware

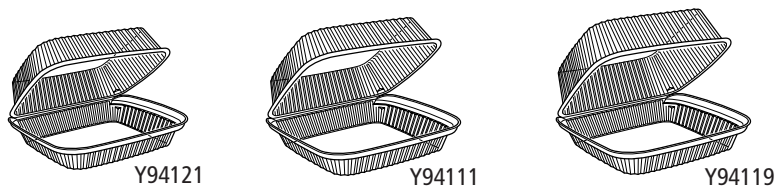

## ClearView™ SmartLock® Containers

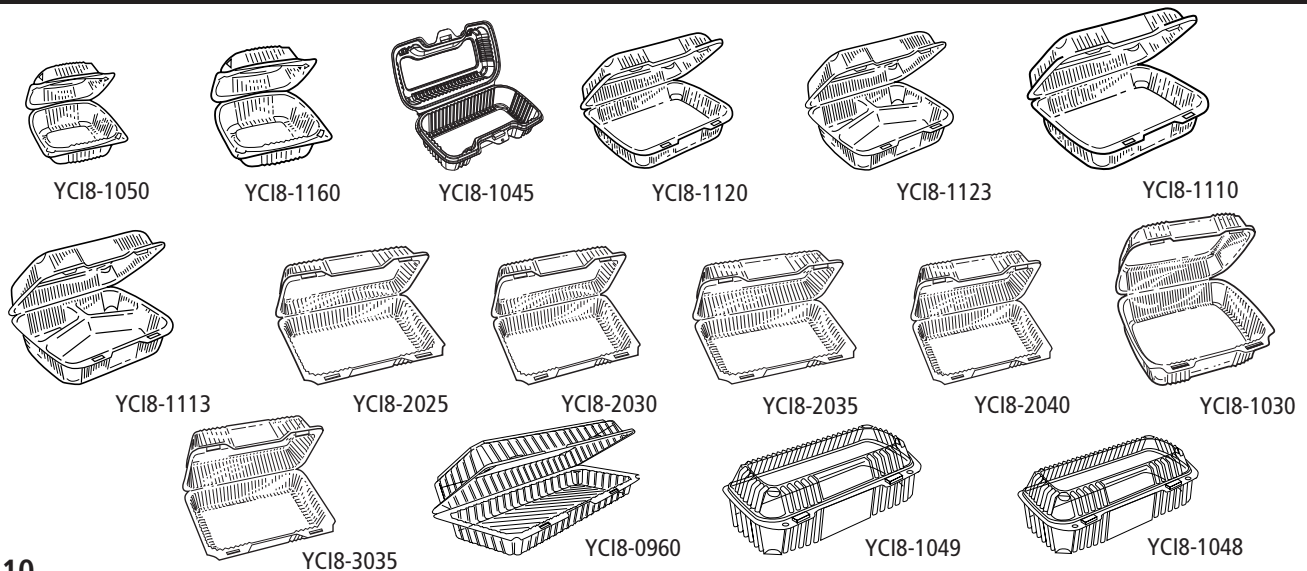

**Pressware® Ebony Premier® Dual-Ovenable Paperboard Trays – Black**

Product Number	Description	Capacity (fl. oz.)	Dimensions (in inches)			Vert. Depth	Cube	Case Approx. Wt.	Case Pack
			Top Out	Top In	Bottom				
PEP 4512	Oblong Tray	13.0	4 7/8 x 5 29/32	4 3/8 x 5 7/16	3 17/32 x 4 9/16	1 1/4	2.17	29.17	1000
PEP 5613RR1	Oblong Tray (rounded corners)	14.5	4 29/32 x 6 17/32	4 11/32 x 6 1/32	3 1/2 x 5	1 3/8	1.47	17.51	500
C18 5613R	Obong Dome Lid for 5613R	–	5 3/32 x 6 25/32	–	–	7/8	5.41	15.00	1000
PEP 5615	Oblong Tray	16.8	4 15/16 x 6 3/32	4 13/32 x 5 19/32	3 3/16 x 4 5/16	1 11/16	1.63	21.49	500
C18 5615	Oblong Dome Lid for 4512 & 5615	–	5 3/32 x 6 11/32	–	–	1/2	3.36	13.00	1000
PEP 5713R	Oblong Tray (rounded corners)	21.3	5 15/32 x 7 15/32	4 31/32 x 6 15/16	4 3/32 x 6	1 3/8	2.53	25.70	500
C18 5713R	Obong Dome Lid for 5713R	–	5 11/16 x 7 11/16	–	–	1/4	2.23	10.00	500
PEP 6815	Oblong Tray	36.7	6 9/16 x 8 3/4	6 3/32 x 8 1/4	5 1/8 x 7 1/16	1 5/8	1.74	19.47	250
C18 6815	Oblong Dome Lid for 6815	–	6 31/32 x 9 1/8	–	–	1/4	2.22	12.00	250
PEP 6816	Oblong Tray	32.0	6 1/32 x 7 15/16	5 1/2 x 7 3/8	4 1/4 x 6 1/8	1 3/4	2.36	31.52	500
C18 6816	Obong Dome Lid for 6816	–	6 1/4 x 8 1/8	–	–	3/8	2.91	12.00	500
PEP 7014	Oblong Tray	45.0	7 15/32 x 9 31/32	6 31/32 x 9 15/32	6 x 8 5/16	1 1/2	2.05	21.51	250
YC18 D7140001	Obong Dome Lid for 7014	–	7 23/32 x 10 7/32	–	–	3/4	2.55	11.00	280

**Clear OPS Dome Lids for Pressware® Trays**

Product Number	Description	Capacity (fl. oz.)	Dimensions (in inches)			Vert. Depth	Cube	Case Approx. Wt.	Case Pack
			Top Out	Top In	Bottom				
C18 5613	Oblong Dome Lid for 5613	–	5 7/32 x 6 13/16	–	–	7/8	4.82	13.0	1000
C18 5613R	Obong Dome Lid for 5613R	–	5 3/32 x 6 25/32	–	–	7/8	5.41	15.0	1000
C18 5615	Oblong Dome Lid for 5615	–	5 3/32 x 6 11/32	–	–	1/2	3.36	13.0	1000
C18 5710	High Dome Lid for 5710	–	5 5/16 x 8 1/16	–	–	1 1/8	2.92	11.0	500
C18 5713	Low Dome Lid for 5713	–	5 5/16 x 8 1/32	–	–	1/2	1.18	6.00	250
C18 5713R	Obong Dome Lid for 5713R, 5716R	–	5 11/16 x 7 11/16	–	–	1/4	2.23	10.0	500
C18 6815	Oblong Dome Lid for 6815	–	6 31/32 x 9 1/8	–	–	1/4	2.22	12.0	250
C18 6816	Oblong Dome Lid for 6816	–	6 1/4 x 8 1/8	–	–	3/8	2.91	12.0	500
YC18 D7140001	Oblong Dome Lid for 7014	–	7 23/32 x 10 7/32	–	–	3/4	2.55	11.0	280

Do Not Place Dome Lids In Conventional or Microwave Ovens

**The Sell Out® Hingeware**

Product Number	Description	Capacity (fl. oz.)	Dimensions (in inches)			Vert. Depth	Case		Case Sleeve	Cases/ Unit Load	
			Top Out	Top In	Bottom		Cube	Weight			
Y94121	Medium Deep Clear Hingeware	--	9 x 8	7 3/4 x 6 3/4	6 7/16 x 5 7/16	3 3/8	2.07	16.56	2/90	180	24
Y94130	Medium Low Profile Clear Hingeware	--	9 x 8	7 3/4 x 6 3/4	7 1/4 x 6 1/4	1 13/16	2.07	16.56	2/90	180	24
Y94111	Large Deep Clear Hingeware	51B + 50 1/2L	9 1/2 x 9 1/2	8 3/16 x 8 1/4	6 7/8 x 6 7/8	3 3/8	2.57	15.34	2/80	160	20
Y94119	Large Super Deep Clear Hingeware	63B/52L	9 1/2 x 9 1/2	8 3/16 x 8 1/4	6 7/8 x 6 7/8	3 7/8	2.81	18.29	2/85	170	20

**ClearView™ SmartLock® Containers**

Product Number	Description	Capacity (fl. oz.)	Dimension (in inches)	Cube	Case Approx. Wt.	Packing		Cases/ Unit Load
						Sleeve	Case	
YC18-1160	Clear 6" Hinged Lid w/1-Cmpt. Tray	20 oz.	5 3/4 x 6 x 3	2.92	19.26	4/125	500	18
YC18-1050	Clear 5" Hinged Lid w/1-Cmpt. Tray	11 oz.	5 1/4 x 5 1/4 x 2 1/2	1.75	11.24	3/125	375	36
YC18-1045	Clear Single Tab Hotdog Container	--	6 1/2 x 2 3/4 x 2 1/4	1.58	8.27	2/125	250	36
YC18-1048	Clear 7 1/2" Hoagie Package	23 oz.	8 1/2 x 4 x 3 1/4	1.70	11.06	2/125	250	30
YC18-1049	Clear 9" Hoagie Package	27 oz.	9 1/4 x 4 1/2 x 3	1.98	12.76	2/125	250	30
YC18-1120	Clear Medium Hinged Lid w/1-Cmpt. Tray	49 oz.	8 13/64 x 8 11/32 x 2 29/32	2.13	15.60	1/200	200	24
YC18-1123	Clear Medium Hinged Lid w/3-Cmpt. Tray	5 oz.(S) - 14 oz.(L)	8 13/64 x 8 11/32 x 2 29/32	2.13	15.80	1/200	200	24
YC18-1110	Clear Large Hinged Lid w/1-Cmpt. Tray	62 oz.	9 7/32 x 8 7/8 x 2 29/32	2.61	18.13	2/100	200	20
YC18-1113	Clear Large Hinged Lid w/3-Cmpt. Tray	6.7 oz.(S) - 24 oz.(L)	9 7/32 x 8 7/8 x 2 29/32	2.61	18.35	2/100	200	20
YC18-2025	Clear Small Hinged Lid	33 oz.	6 23/32 x 8 35/64 x 2 21/32	2.23	16.94	2/140	280	27
YC18-2030	Clear Hinged Lid w/1-Cmpt. Tray (SS)	22 oz.	9 1/4 x 6 1/4 x 2	1.99	13.46	2/100	200	30
YC18-2035	Clear Hinged Lid w/1-Cmpt. Tray (DS)	36 oz.	9 1/4 x 6 1/4 x 2 5/8	1.99	13.45	2/100	200	30
YC18-2040	Clear Hinged Lid w/1-Cmpt. Tray (DD)	36 oz.	9 1/4 x 6 1/4 x 3 1/4	1.99	13.58	2/100	200	30
C18-1030	Clear Medium Hinged Lid Container - Deep	39.6 oz.	8 5/8 x 7 1/8 x 3	2.70	16.45	2/125	250	18
YC18-3035	Clear Utility (DS)	82 oz.	10 3/4 x 9 1/4 x 3 1/2	2.38	18.40	2/75	150	24
YC18-0960	Foot-Long Hingeware	53.7 oz.	14 5/8 x 5 5/8 x 3 1/4	4.57	20.00	2/125	250	12

# Reynolds® Clear Hinged Lid Containers

## Showcase® Designer® Bowls

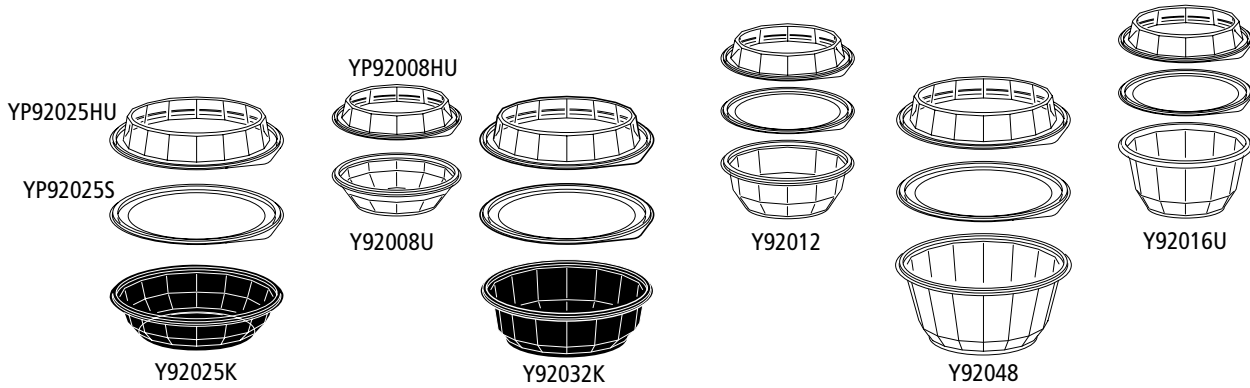

## ClearView™ Roseware® Bowls



## Showcase® Deli Packaging—Bulk Pack

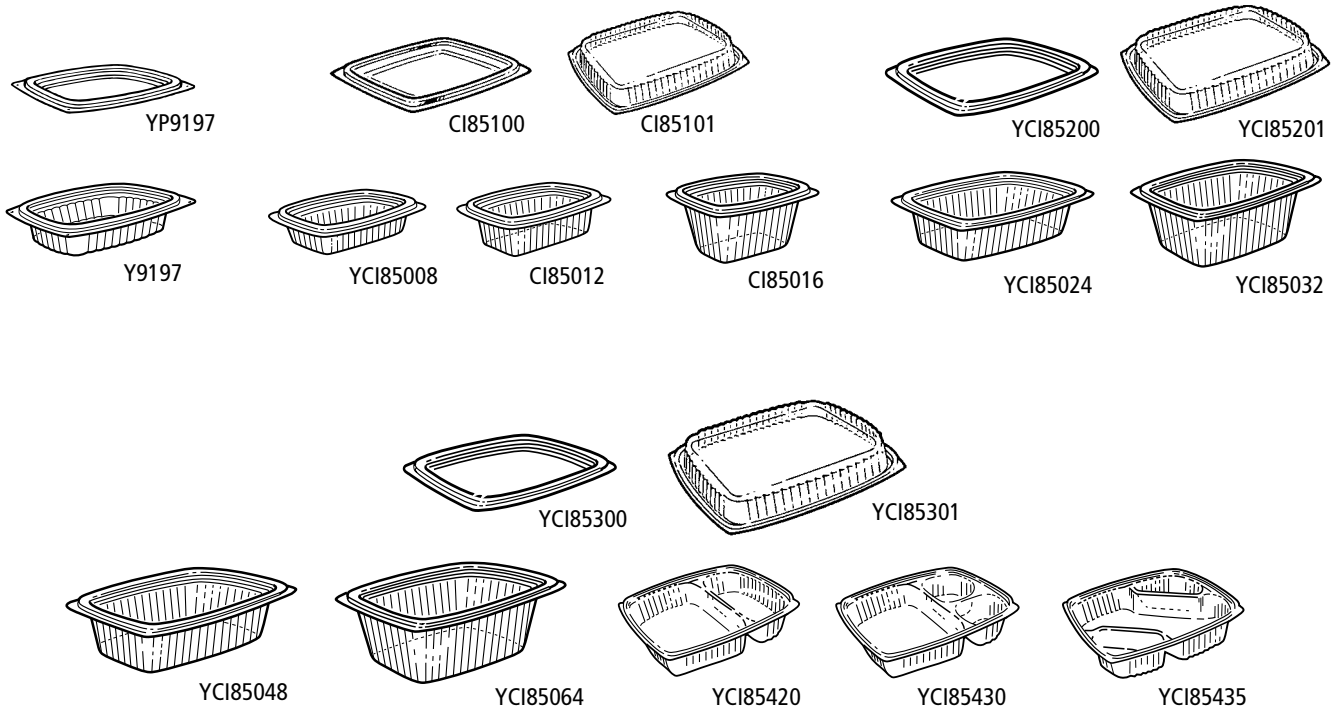



## Reynolds® Clear Hinged Lid Containers

Product Number	Description	Dimensions (in inches)	Case		Case		Cases/ Unit Load
			Cube	Weight	Sleeve	Pack	
11970	10" Hingeware	10 x 10	5.39	28.98	2/100	200	20
11974	6" Enhanced Hingeware	6 x 6	5.72	18.47	6/84	504	16
12016	5" Enhanced Hingeware	5 x 5	4.42	14.00	6/84	504	20
2155P300	Square Hinged Bar-Lock	8.25 x 9 x 3	3.70	28.70	1/300	300	24
2170P200	Large Square Hinged Bar-Lock	8.1 x 8.75 x 3.5	2.82	18.22	1/200	200	30
2175	Small Danish Hinged Bar-Lock	12.44 x 6.38 x 2.25	1.43	10.00	1/100	100	54
2221	5" Square Hinged Bar-Lock	5.75 x 5.2 x 3.25	3.34	18.23	4/125	500	16

## Showcase® Designer® Bowls

Product Number	Description	Capacity (fl. oz.)	Dimensions (in inches)			Vert. Depth	Case		Case Pack	Cases/ Unit Load	
			Top Out	Top In	Bottom		Cube	Approx. Wt.			
Y92008U	8 oz. Clear Bowl	8.0	5 <sup>15</sup> / <sub>32</sub>	4 <sup>25</sup> / <sub>32</sub>	3 <sup>3</sup> / <sub>8</sub>	1 <sup>25</sup> / <sub>32</sub>	1.44	4.51	4/75	300	32
Y92012	12 oz. Clear Bowl	12.0	5 <sup>15</sup> / <sub>32</sub>	4 <sup>25</sup> / <sub>32</sub>	3 <sup>5</sup> / <sub>16</sub>	1 <sup>7</sup> / <sub>8</sub>	1.58	4.79	4/75	300	32
Y92016U	16 oz. Clear Bowl	16.0	5 <sup>15</sup> / <sub>32</sub>	4 <sup>25</sup> / <sub>32</sub>	3 <sup>1</sup> / <sub>16</sub>	2 <sup>39</sup> / <sub>64</sub>	1.66	6.65	4/75	300	32
YP92008HU	Dome Lid	--	5 <sup>15</sup> / <sub>32</sub>	--	--	<sup>15</sup> / <sub>16</sub>	1.23	4.48	4/75	300	36
Y92025U	24 oz. Clear Shallow Bowl	24.0	7 <sup>15</sup> / <sub>32</sub>	6 <sup>25</sup> / <sub>32</sub>	5 <sup>9</sup> / <sub>32</sub>	1 <sup>51</sup> / <sub>64</sub>	3.06	9.49	4/75	300	18
Y92025K	24 oz. Black Shallow Bowl	24.0	7 <sup>15</sup> / <sub>32</sub>	6 <sup>25</sup> / <sub>32</sub>	5 <sup>7</sup> / <sub>64</sub>	1 <sup>51</sup> / <sub>64</sub>	3.06	10.76	4/75	300	18
Y92032U	32 oz. Clear Bowl	32.0	7 <sup>15</sup> / <sub>32</sub>	6 <sup>25</sup> / <sub>32</sub>	5 <sup>7</sup> / <sub>64</sub>	2 <sup>5</sup> / <sub>16</sub>	3.05	11.00	6/50	300	18
Y92032K	32 oz. Black Bowl	32.0	7 <sup>15</sup> / <sub>32</sub>	6 <sup>25</sup> / <sub>32</sub>	4 <sup>47</sup> / <sub>64</sub>	2 <sup>5</sup> / <sub>16</sub>	3.03	11.94	6/50	300	18
Y92048	48 oz. Clear Bowl	48.0	7 <sup>15</sup> / <sub>32</sub>	6 <sup>25</sup> / <sub>32</sub>	4 <sup>7</sup> / <sub>16</sub>	3 <sup>3</sup> / <sub>16</sub>	3.07	14.72	4/75	300	18
YP92025HU	Dome Lid	--	7 <sup>15</sup> / <sub>32</sub>	--	--	<sup>31</sup> / <sub>64</sub>	1.97	9.33	4/75	300	27
YP92025S	Flat Lid	--	7 <sup>15</sup> / <sub>32</sub>	--	--	<sup>17</sup> / <sub>64</sub>	2.96	8.20	4/75	300	18
Y92032SCHU	32 oz. Clear Bowl Combo w/Dome	32.0	7 <sup>15</sup> / <sub>32</sub>	6 <sup>25</sup> / <sub>32</sub>	5 <sup>3</sup> / <sub>32</sub>	2 <sup>5</sup> / <sub>16</sub>	3.35	16.20	2/100	200	15
Y92164SCU	64 oz. Clear Bowl Combo w/Snap-On Lid	64.0	7 <sup>15</sup> / <sub>32</sub>	6 <sup>25</sup> / <sub>32</sub>	4 <sup>7</sup> / <sub>16</sub>	4 <sup>31</sup> / <sub>64</sub>	3.05	10.53	2/75	150	18

## ClearView™ Roseware® Bowls

Product Number	Description	Capacity (fl. oz.)	Dimensions (in inches)			Vert. Depth	Case		Case Pack	Cases/ Unit Load	
			Top Out	Top In	Bottom		Cube	Approx. Wt.			
YEH8-7024	24 oz. Black Bowl Combo w/Lid	24.0	8.13	7.63	4.5	1.88	3.98	19.69	2/110	220	12
YEH8-7035	35 oz. Black Bowl Combo w/Lid	35.0	8.13	7.63	4.5	2.44	3.98	19.69	2/110	220	12

## Showcase® Deli Packaging—Bulk Pack

Product Number	Capacity Description	(fl. oz.)	Case		Case	Packing	Cases/ Unit Load	
			Dimension (in inches)	Cube				Approx Wt.
Y9197	4 oz. Base	4 oz.	4 <sup>7</sup> / <sub>8</sub> x 4 <sup>1</sup> / <sub>8</sub>	2.47	12.23	8/140	1120	24
Y9198	6 oz. Base	6 oz.	4 <sup>7</sup> / <sub>8</sub> x 4 <sup>1</sup> / <sub>8</sub>	2.86	13.89	16/70	1120	21
YP9197	Flat lid for 4, 6 oz. Containers	--	4 <sup>7</sup> / <sub>8</sub> x 4 <sup>1</sup> / <sub>8</sub>	2.38	11.21	12/84	1120	24
YCI85008	Clear 8 oz. Container	8 oz.	5.9 x 4.9 x 4 <sup>3</sup> / <sub>8</sub>	5.00	17.38	16/63	1008	12
CI85012	Clear 12 oz. Container	12 oz.	5.9 x 4.9 x 2	5.17	17.11	16/63	1008	8
CI85016	Clear 16 oz. Container	16 oz.	5.9 x 4.9 x 2 <sup>7</sup> / <sub>8</sub>	5.71	24.05	16/63	1008	8
CI85100	Clear Snap-on Lid for 8, 12, 16 oz. Containers	--	5.9 x 4.9 x 1	3.46	15.86	16/63	1008	16
CI85101	Clear Snap-on Dome Lid for 8, 12, 16 oz. Containers	7.6 oz.	5.9 x 4.9 x 1	2.97	14.97	16/63	1008	16
YCI85024	Clear 24 oz. Container	24 oz.	7 <sup>1</sup> / <sub>2</sub> x 6 <sup>1</sup> / <sub>2</sub> x 2	3.72	14.96	6/84	504	14
YCI85032	Clear 32 oz. Container	32 oz.	7 <sup>1</sup> / <sub>2</sub> x 6 <sup>1</sup> / <sub>2</sub> x 2 <sup>3</sup> / <sub>4</sub>	4.29	19.22	6/84	504	12
YCI85200	Clear Snap-on Lid for 24, & 32 oz. Containers	--	7 <sup>1</sup> / <sub>2</sub> x 6 <sup>1</sup> / <sub>2</sub>	2.75	12.07	6/84	504	18
YCI85201	Clear Snap-on Dome Lid for 24, & 32 oz. Containers	15.3 oz.	7 <sup>1</sup> / <sub>2</sub> x 6 <sup>1</sup> / <sub>2</sub> x 1	2.17	14.30	6/84	504	24
YCI85048	Clear 48 oz. Container	48 oz.	9 x 7.4 x 2 <sup>7</sup> / <sub>16</sub>	2.71	11.32	4/55	220	18
YCI85064	Clear 64 oz. Container	64 oz.	9 x 7.4	2.79	13.49	4/55	220	18
YCI85300	Clear Snap-on Lid for 48 & 64 oz. Containers	--	9 x 7.4	1.71	7.50	4/55	220	30
YCI85301	Clear Snap-on Dome Lid for 48 & 64 oz. Containers	24.4 oz.	9 x 7.4 x 1	2.03	8.28	2/110	220	24
YCI85420	Clear 2-Cmpt. Oblong Container	10 oz.(S) - 23 oz.(L)	9 x 7.4 x 1.5	2.57	11.89	4/55	220	18
YCI85430	Clear 3-Cmpt. Oblong Container	4.5 oz.(S) - 22.5 oz.(L)	9 x 7.4 x 1.5	2.57	9.05	4/55	220	18
YCI85435	Clear 3-Cmpt. Diagonal Container	4.8 oz.(S) - 19.8 oz.(L)	9 x 7.4 x 1.5	2.57	11.89	4/55	220	18

**Showcase® Deli Packaging—Combo Packs**

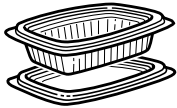

CI86008

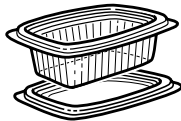

CI86012

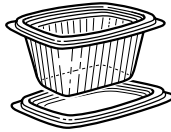

CI86016

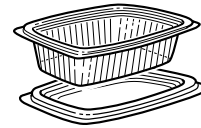

YCI86024

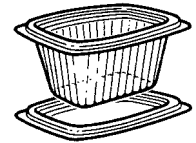

YCI86032

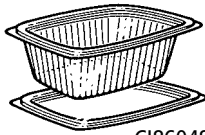

CI86048

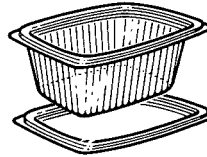

CI86064

**ClearView™ Portion Platters and Domes**



YP95105



Y96140KPP



95240W



95940K

**ClearView™ Medium & Large Platters and Domes**



YP95109



YP95107



Y95980K



Y95970K



Y96180PP



Y96180KPP

**ClearView™ Entree Platters and Domes**



Y95200W

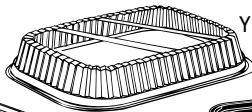

YP95108



Y95900K



Y96100KEP

**ClearView™ Nacho Trays— Clear Lids, Clear Bases**



YCI88062



YCI88068

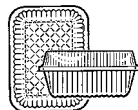

YCI88063

**EarthChoice® PLA Hinged & Deli Containers**



YLI811600000



YLI811200000

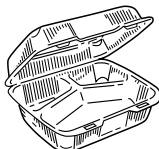

YLI811230000

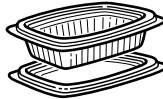

YLI860080000



YLI860160000

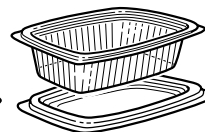

YLI860240000

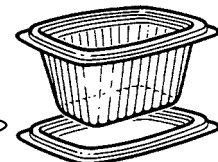

YLI860320000

### Showcase® Deli Packaging—Combo Packs

Product Number	Description	Capacity (fl. oz.)	Dimension (in inches)	Cube	Case		Packing		Cases/ Unit Load
					Approx Wt.	Sleeve	Case		
CI86008	Clear 8 oz. Container w/Flat Lid	8 oz.	5.9 x 4.9 x 1 3/8	2.22	8.29	4/63 ea.	252 ea.	16	
CI86012	Clear 12 oz. Container w/Flat Lid	12 oz.	5.9 x 4.9 x 2	2.24	7.94	4/63 ea.	252 ea.	16	
CI86016	Clear 16 oz. Container w/Flat Lid	16 oz.	5.9 x 4.9 x 2 7/8	2.33	11.60	4/63 ea.	252 ea.	20	
YCI86024	Clear 24 oz. Container w/Flat Lid	24 oz.	7.5 x 6.5 x 2	2.68	10.73	4/50 ea.	200 ea.	18	
YCI86032	Clear 32 oz. Container w/Flat Lid	32 oz.	7.5 x 6.5 x 2 3/4	2.93	13.16	4/50 ea.	200 ea.	18	
CI86048	Clear 48 oz. Container w/Flat Lid	48 oz.	9 x 7.4 x 2 7/16	2.81	12.72	2/63 ea.	126 ea.	18	
CI86064	Clear 64 oz. Container w/Flat Lid	64 oz.	9 x 7.4 x 3 3/16	2.81	11.78	2/63 ea.	126 ea.	18	

### ClearView™ Portion Platters and Domes

Product Number	Description	Capacity (fl. oz.)	Dimensions (in inches)			Cube	Case Approx. Wt.	Vert. Depth	Case Sleeve	Case Pack	Cases/ Unit Load
			Top Out	Top In	Bottom						
Y96140KPP	Black Portion Platter Tray & Lid Combo	--	7 x 6	5 7/8 x 4 15/16	5 1/4 x 4 1/4	3.49	21.60	1 1/8	4/140	560	16
95240W	White Portion Platter	11	7 x 6	5 7/8 x 4 15/16	5 1/4 x 4 1/4	2.63	10.90	1 1/8	4/125	500	24
95940K	Black Portion Platter	11	7 x 6	5 7/8 x 4 15/16	5 1/4 x 4 1/4	2.63	10.38	1 1/8	4/125	500	24
YP95105	Clear Portion Platter Dome Lid	14 1/2	6 1/2 x 5 1/2	5 5/8 x 4 5/8	5 x 4	1.21	8.64	1 3/16	4/125	500	48

### ClearView™ Medium Platters and Domes

Product Number	Description	Capacity (fl. oz.)	Dimensions (in inches)			Cube	Case Approx. Wt.	Vert. Depth	Case Sleeve	Case Pack	Cases/ Unit Load
			Top Out	Top In	Bottom						
Y95980K	Black Deep Medium Platter	20	9 x 5 1/2	7 7/8 x 4 1/8	6 5/8 x 3 1/8	4.26	21.16	1 5/8	6/100	600	12
Y95970K	Black Shallow Medium Platter	13	9 x 5 1/2	7 1/2 x 4 1/16	7 1/8 x 3 5/8	3.94	12.29	1 1/8	8/75	600	12
YP95107	Clear Shallow Medium Platter Dome Lid	19	8 5/8 x 5 1/8	7 7/8 x 4 1/8	7 1/16 x 3 3/8	1.34	11.46	1 1/4	2/300	600	40
YP95109	Clear Deep Medium Platter Dome Lid	26	8 5/8 x 5 1/8	7 7/8 x 4 1/8	6 5/8 x 3 1/8	1.37	16.91	1 3/4	6/100	600	45
Y96180PP	Clear Medium Platter Tray & Lid Combo	20	9 x 5 1/2	7 7/8 x 4 1/8	6 5/8 x 3 1/8	1.88	12.39	2 1/4	2/100	200	30
Y96180KPP	Black Medium Deep Platter Tray & Lid Combo	20	9 x 5 1/2	7 7/8 x 4 1/8	6 5/8 x 3 1/8	1.88	15.75	2 1/4	2/100	200	30

### ClearView™ Entree Platters and Domes

Product Number	Description	Capacity (fl. oz.)	Dimensions (in inches)			Cube	Case Approx. Wt.	Vert. Depth	Case Sleeve	Case Pack	Cases/ Unit Load
			Top Out	Top In	Bottom						
Y95200W	White Entree Platter	22	10 1/8 x 7 3/8	8 3/4 x 5 7/8	8 3/8 x 5 1/2	4.58	21.50	1 3/16	4/125	500	12
Y95900K	Black Entree Platter	22	10 1/8 x 7 3/8	8 3/4 x 5 7/8	8 3/8 x 5 1/2	4.58	22.83	1 3/16	4/125	500	12
YP95108	Clear Deep Entree Platter Dome	32	9 3/4 x 7	8 7/8 x 6 1/8	8 x 5 1/4	1.90	16.88	1 1/4	4/125	500	24
Y96100KEP	Black Large Platter Tray & Lid Combo	22	10 1/8 x 7 3/8	8 3/4 x 5 7/8	8 3/8 x 5 1/2	3.50	21.75	2 1/4	2/140	280	16

### ClearView™ Nacho Trays— Clear Lids, Clear Bases

Product Number	Description	Capacity (fl. oz.)	Dimensions (in inches)	Case		Packing		Cases/ Unit Load
				Cube	Approx Wt.	Sleeve	Case	
YCI88062	Clear 2-Cmpt. Nacho Tray	2.5 oz.(S) - 9.75 oz. (L)	6 1/2 x 5 x 1 3/4	0.79	8.41	4/125	500	70
YCI88068	Clear Large 2-Cmpt. Nacho Tray	3.5 oz.(S) - 15.5 oz. (L)	6 x 8 x 1 3/4	1.50	11.04	4/125	500	36
YCI88063	Clear 1-Cmpt. Tray & Lid Combo	20 oz.	6 1/2 x 5 x 1 3/4	1.61	9.07	2/126	252	32

### EarthChoice® PLA Hinged & Deli Containers

Item#	Description	Capacity	Dimensions	Case		Case		Cases/ Unit Load
				Cube	Weight	Sleeve	Pack	
<b>Clear Hinged Lid Containers</b>								
YLI811600000	EarthChoice® 6 in. Clear Hinged Container	20	5 3/4 x 6 x 3	3.33	22.80	4/125	500	16
YLI811200000	EarthChoice® Medium 1-Cmpt. Clear Hinged Cont.	49	8 13/64 x 8 11/32 x 2 29/32	2.06	17.93	2/100	200	24
YLI811230000	EarthChoice® Medium 3-Cmpt. Clear Hinged Cont.	5 (sm), 14 (lg)	8 13/64 x 8 11/32 x 2 29/32	2.06	17.93	2/100	200	24
<b>Clear Deli Containers &amp; Lids</b>								
YLI860080000	EarthChoice® 8 oz. Clear Deli Container w/Lid	8	5.9 x 4.9 x 1.25	2.26	10.03	5/51	255	24
YLI860160000	EarthChoice® 16 oz. Clear Deli Container w/Lid	16	5.9 x 4.9 x 2.75	2.56	11.82	5/51	255	24
YLI860240000	EarthChoice® 24oz. Clear Deli Container w/Lid	24	7.5 x 6.5	2.68	10.73	2/100	200	18
YLI860320000	EarthChoice® 32 oz. Clear Deli Container w/Lid	32	7.5 x 6.5 x 2.70	2.93	13.85	4/50	200	18

## Newspring VERSAtainer® Microwaveable Containers - Oval

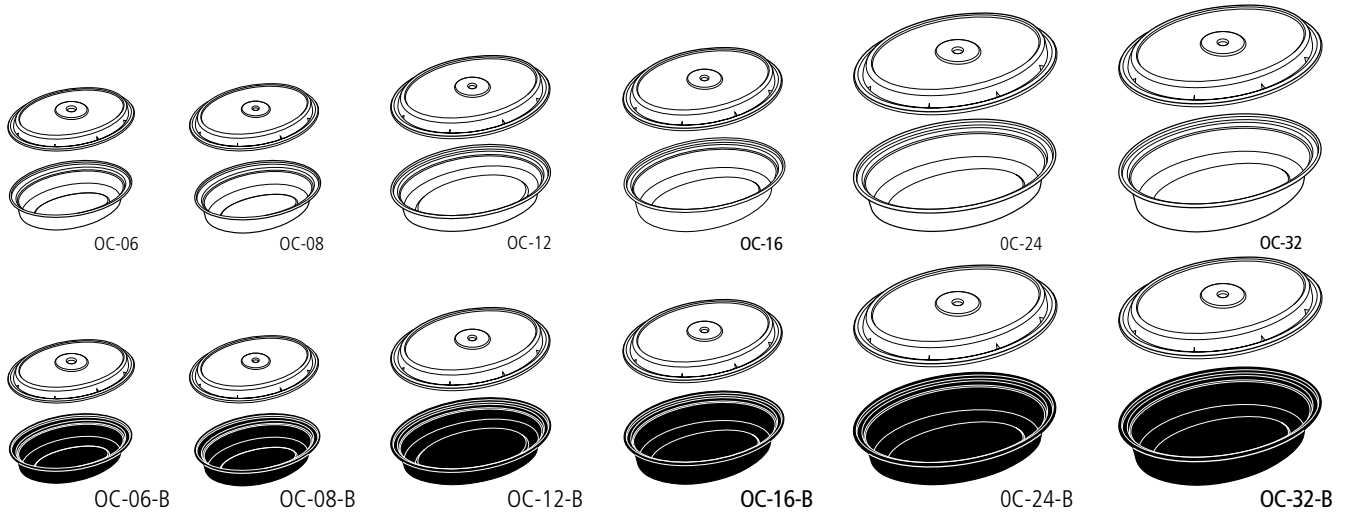

## Newspring VERSAtainer® Microwaveable Containers - Square

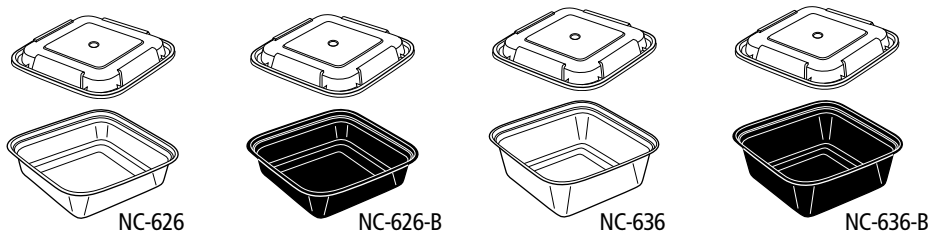

## Newspring VERSAtainer® Microwaveable Containers - Rectangular

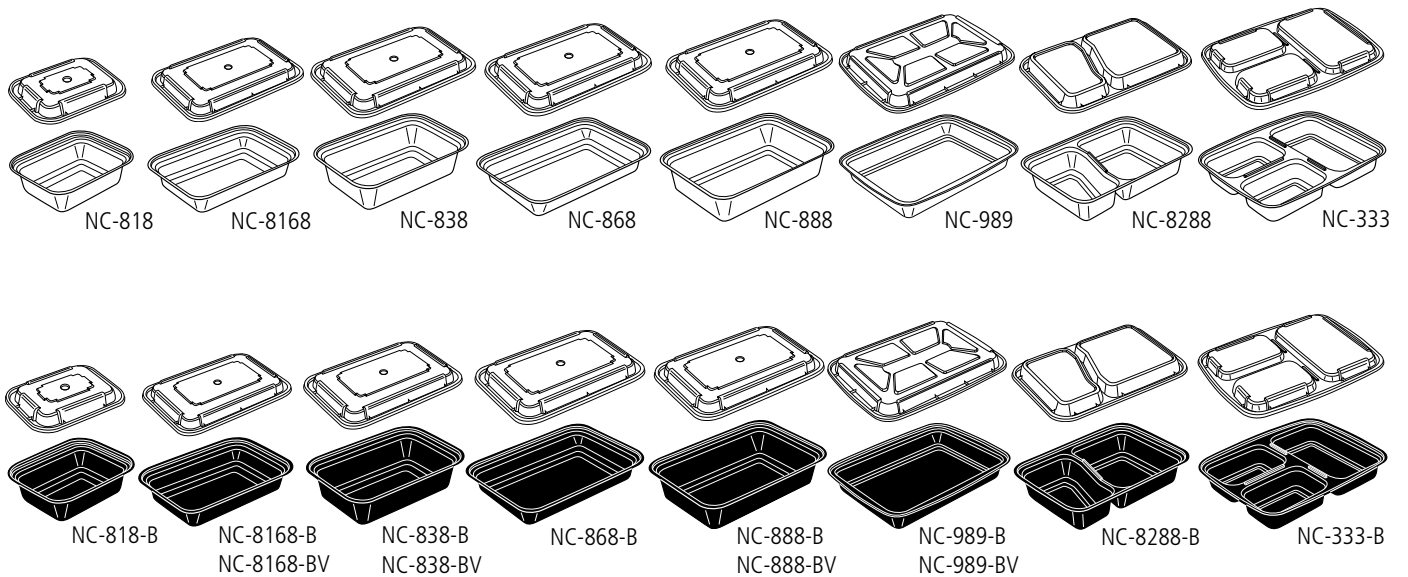

## Newspring VERSAtainer® Microwaveable Containers - Oval

Product #	Description	Dimensions	Case Pack	Case Cube	Case Weight (lbs.)	Pallet Count
OC-06	6 oz. white base w/ clear lid	5.7" x 4.0" x 1.1"	150 ea.	1.06	7.27	72
OC-06-B	6 oz. black base w/ clear lid	5.7" x 4.0" x 1.1"	150 ea.	1.06	7.27	72
OC-08	8 oz. white base w/ clear lid	5.7" x 4.0" x 1.45"	150 ea.	1.08	7.56	72
OC-08-B	8 oz. black base w/ clear lid	5.7" x 4.0" x 1.45"	150 ea.	1.08	7.56	72
OC-12	12 oz. white base w/ clear lid	6.8" x 4.8" x 1.45"	150 ea.	1.37	10.23	54
OC-12-B	12 oz. black base w/ clear lid	6.8" x 4.8" x 1.45"	150 ea.	1.37	10.23	54
OC-16	16 oz. white base w/ clear lid	6.8" x 4.8" x 1.9"	150 ea.	1.46	10.73	54
OC-16-B	16 oz. black base w/ clear lid	6.8" x 4.8" x 1.9"	150 ea.	1.46	10.73	54
OC-24	24 oz. white base w/ clear lid	9.1" x 6.7" x 1.45"	150 ea.	2.57	18.35	24
OC-24-B	24 oz. black base w/ clear lid	9.1" x 6.7" x 1.45"	150 ea.	2.57	18.35	24
OC-32	32 oz. white base w/ clear lid	9.1" x 6.7" x 1.9"	150 ea.	2.63	17.91	24
OC-32-B	32 oz. black base w/ clear lid	9.1" x 6.7" x 1.9"	150 ea.	2.63	17.91	24

## Newspring VERSAtainer® Microwaveable Containers - Square

Product #	Description	Dimensions	Case Pack	Case Cube	Case Weight (lbs.)	Pallet Count
NC-626	26 oz. white base w/ clear lid	6.75" x 6.75" x 2"	150 ea.	2.13	17.29	30
NC-626-B	26 oz. black base w/ clear lid	6.75" x 6.75" x 2"	150 ea.	2.13	17.29	30
NC-636	36 oz. white base w/ clear lid	6.75" x 6.75" x 2.6"	150 ea.	2.23	19.19	30
NC-636-B	36 oz. black base w/ clear lid	6.75" x 6.75" x 2.6"	150 ea.	2.23	19.19	30

## Newspring VERSAtainer® Microwaveable Containers - Rectangular

Product #	Description	Dimensions	Case Pack	Case Cube	Case Weight (lbs.)	Pallet Count
NC-818	12 oz. white base w/ clear lid	4.5" x 5.5" x 1.75"	150 ea.	1.10	9.57	54
NC-818-B	12 oz. black base w/ clear lid	4.5" x 5.5" x 1.75"	150 ea.	1.10	9.57	54
NC-8168	16 oz. white base w/ clear lid	5" x 7.25" x 1.5"	150 ea.	1.35	14.15	60
NC-8168-B	16 oz. black base w/ clear lid	5" x 7.25" x 1.5"	150 ea.	1.35	14.15	60
NC-838	24 oz. white base w/ clear lid	5" x 7.25" x 2"	150 ea.	1.39	13.68	60
NC-838-B	24 oz. black base w/ clear lid	5" x 7.25" x 2"	150 ea.	1.39	13.68	60
NC-868	28 oz. white base w/ clear lid	6" x 8.5" x 1.5"	150 ea.	1.89	18.59	40
NC-868-B	28 oz. black base w/ clear lid	6" x 8.5" x 1.5"	150 ea.	1.89	18.59	40
NC-888	38 oz. white base w/ clear lid	6" x 8.5" x 2"	150 ea.	1.96	19.04	40
NC-888-B	38 oz. black base w/ clear lid	6" x 8.5" x 2"	150 ea.	1.96	19.04	40
NC-989	58 oz. white base w/ clear lid	8.5" x 11.5" x 1.5"	150 ea.	2.82	33.89	20
NC-989-B	58 oz. black base w/ clear lid	8.5" x 11.5" x 1.5"	150 ea.	2.82	33.89	20
<b>Two Compartments (12 oz/18 oz)</b>						
NC-8288	30 oz. white base w/ clear lid	6" x 8.5" x 1.875"	150 ea.	1.98	18.50	40
NC-8288-B	30 oz. black base w/ clear lid	6" x 8.5" x 1.875"	150 ea.	1.98	18.50	40
<b>Three Compartments (8 oz/8 oz/16 oz)</b>						
NC-333	32 oz. white base w/ clear lid	7.5" x 9.875" x 1.75"	150 ea.	2.35	27.97	32
NC-333-B	32 oz. black base w/ clear lid	7.5" x 9.875" x 1.75"	150 ea.	2.35	27.97	32
<b>Vented Containers</b>						
NC-8168-BV	16 oz. black base w/ vented clear lid	5" x 7.25" x 1.5"	150 ea.	1.58	14.15	48
NC-838-BV	24 oz. black base w/ vented clear lid	5" x 7.25" x 2"	150 ea.	1.77	13.68	42
NC-888-BV	38 oz. black base w/ vented clear lid	6" x 8.5" x 2"	150 ea.	1.96	19.04	40
NC-989-BV	58 oz. black base w/ vented clear lid	8.5" x 11.5" x 1.5"	150 ea.	2.82	33.89	20

\* All products listed above are shipped in 150 count containers/clear lid combination packs. All products listed above are also available in a 300 count bulk pack by special order only.

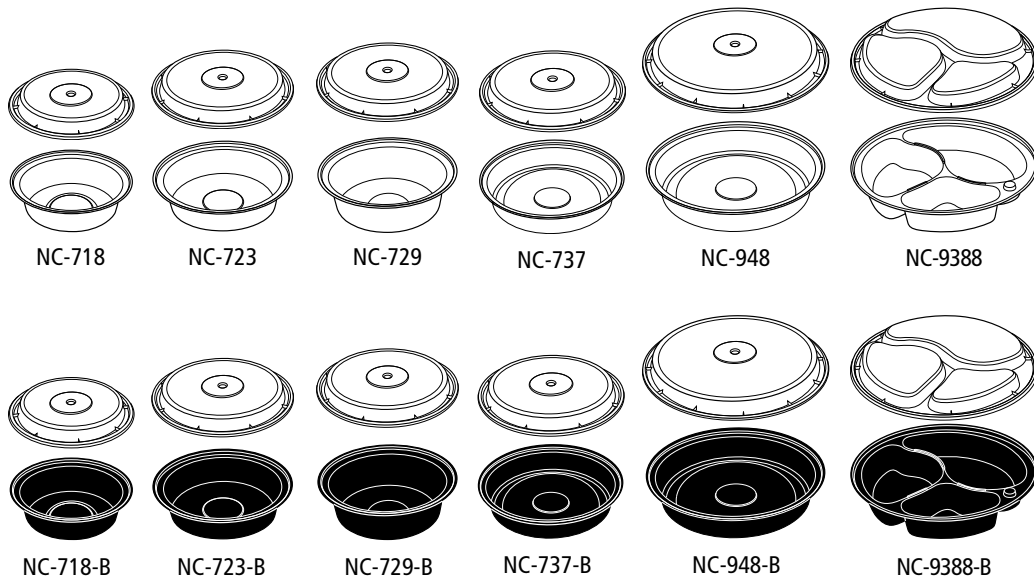

## Newspring VERSAtainer® Microwaveable Containers - Round

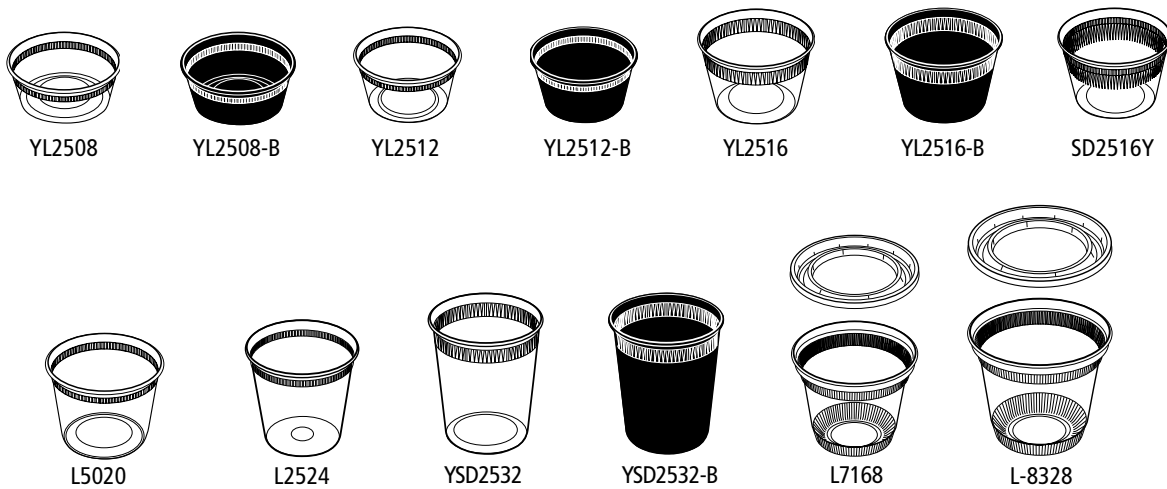

## Newspring DELItainer® Microwaveable Deli Containers



### Newspring Deli Lid Printing Matrix

Item #	Description	Minimums	
		Cases	Pieces
YNL500	 Deli Recessed Lid Bulk 480	225	108,000
		150	72,000
FL500Y	 Deli Recessed Lid Bulk 480	100	48,000
		75	36,000
TL500Y	 Deli Tamper Evident Lid Bulk 480	50	24,000
		25	12,000

Lead Time - 1st order 6 weeks / subsequent orders - 2 weeks.  
 All orders to be combined with other items to make full truckload delivery.  
 RMC orders will be transferred to the RMC upon completion of the print job.

## Newspring VERSAtainer® Microwaveable Containers - Round

Product #	Description	Dimensions	Case Pack	Case Cube	Case Weight (lbs.)	Pallet Count
NC-718	16 oz. white base w/ clear lid	6"	150 ea.	1.75	12.81	42
NC-718-B	16 oz. black base w/ clear lid	6"	150 ea.	1.75	12.81	42
NC-723	24 oz. white base w/ clear lid	7"	150 ea.	1.94	16.30	40
NC-723-B	24 oz. black base w/ clear lid	7"	150 ea.	1.94	16.30	40
NC-729	32 oz. white base w/ clear lid	7"	150 ea.	1.94	17.16	40
NC-729-B	32 oz. black base w/ clear lid	7"	150 ea.	1.94	17.16	40
NC-737	35 oz. white base w/ clear lid	8"	150 ea.	2.84	22.95	24
NC-737-B	35 oz. black base w/ clear lid	8"	150 ea.	2.84	22.95	24
NC-948	48 oz. white base w/ clear lid	9"	150 ea.	3.25	26.42	18
NC-948-B	48 oz. black base w/ clear lid	9"	150 ea.	3.25	26.42	18
<b>Three Compartments (7 oz/12 oz/20 oz)</b>						
NC-9388	39 oz. white base w/ clear lid	9"	150 ea.	3.35	31.86	24
NC-9388-B	39 oz. black base w/ clear lid	9"	150 ea.	3.35	31.86	24
<b>Vented Containers</b>						
NC-948-BV	48 oz. black base w/ vented clear lid	9"	150 ea.	3.72	26.42	16

## Newspring DELtainer® Microwaveable Deli Containers

Product #	Description	Dimensions	Case Pack	Case Cube	Case Weight (lbs.)	Pallet Count
YL2508	8 oz. clear deli combo pack	4.55" dia x 1.8"	250 ea.	2.36	14.54	32
YL2508-B	8 oz. black deli combo pack	4.55" dia x 1.8"	250 ea.	2.36	14.54	32
L5008Y	8 oz. clear deli bulk pack	4.55" dia x 1.8"	500	2.10	15.84	40
YL2512	12 oz. clear deli combo pack	4.55" dia x 2.45"	250 ea.	2.15	17.02	32
YL2512-B	12 oz. black deli combo pack	4.55" dia x 2.45"	250 ea.	2.15	17.02	32
L5012Y	12 oz. clear deli bulk pack	4.55" dia x 2.45"	500	2.14	20.42	32
YSD2516	16 oz. clear deli combo pack	4.55" dia x 3.05"	250 ea.	2.15	18.68	32
SD5016Y	16 oz. clear deli bulk pack	4.55" dia x 3.05"	500	2.18	24.08	32
YL2520	20 oz. clear deli combo pack	4.55" dia x 3.45"	250 ea.	2.46	19.66	32
L5020Y	20 oz. clear deli bulk pack	4.55" dia x 3.45"	500	2.70	26.47	32
YL2524	24 oz. clear deli combo pack	4.55" dia x 4.35"	250 ea.	2.47	21.80	32
L5024Y	24 oz. clear deli bulk pack	4.55" dia x 4.35"	500	2.47	30.72	32
YSD2532	32 oz. clear deli combo pack	4.55" dia x 5.55"	250 ea.	4.23	30.53	15
YSD2532-B	32 oz. black deli combo pack	4.55" dia x 5.55"	250 ea.	4.23	30.53	15
SD5032Y	32 oz. clear deli bulk pack	4.55" dia x 5.55"	500	5.95	47.14	12
YNL500	Recessed Lid fits 8, 12, L-16, SD-16, 20, 24, 32 oz.	4.55" dia x .40"	500	2.42	13.29	32
FL500Y	Overcap Lid fits 8, 12, L-16, SD-16, 20, 24, 32 oz.	4.55" dia x .345"	500	1.80	10.00	32
TL500Y	Overcap Lid fits 8, 12, L-16, SD-16, 20, 24, 32 oz.	4.55" dia x .345"	1000	3.95	20.00	16
<b>Squat DELtainer Packaging</b>						
L-7168	16 oz. clear squat combo pack	4.55" dia x 3.9"	200 ea.	2.39	18.85	30
L-8328	32 oz. clear squat combo pack	5.5" dia x 4.9"	200 ea.	4.09	30.59	16

\*Products are available in white by special order only.

**For custom printed Deli Lids, please contact your Pactiv Sales Representative.**

## Newspring DELtainer® Microwaveable Tubs

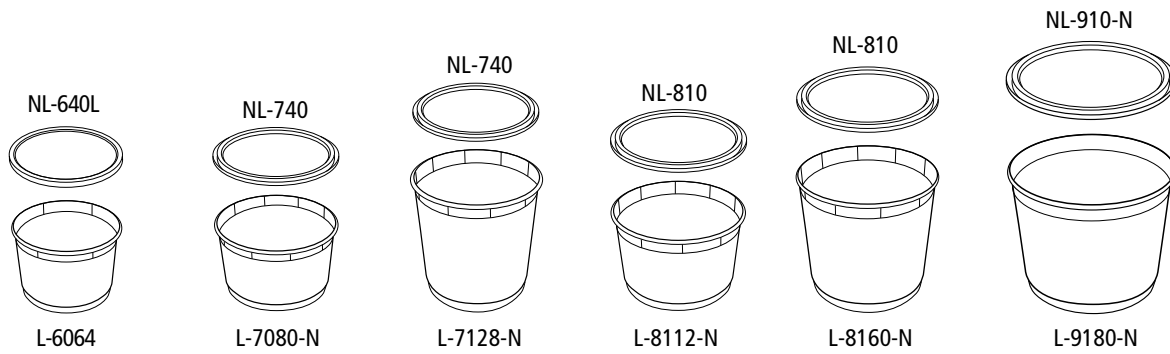

## Newspring TEtainer® Tamper Evident Container

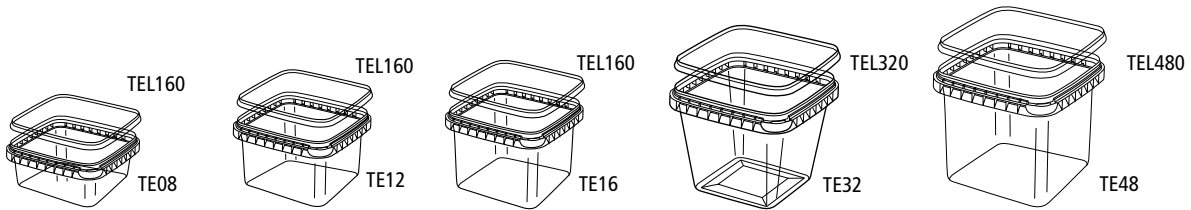

## Clear Advantage™ SmartLock® Bakery/Deli Hingeware – RPET

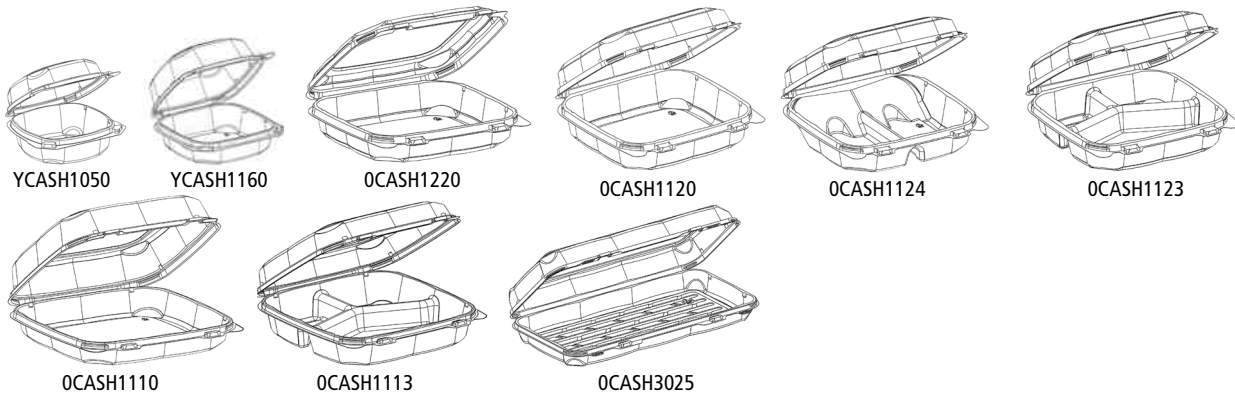

## Ultra Pac® Hingeware – PETE

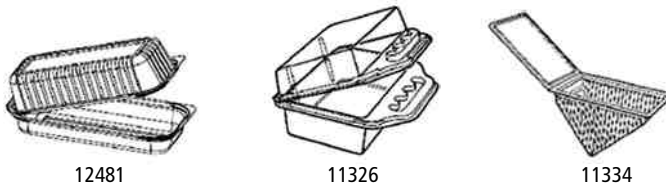

## Ultra Pac® Hingeware - PETE

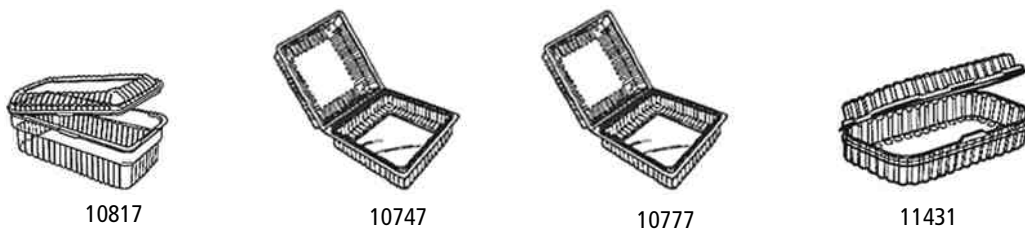



## Newspring DELtainer® Microwaveable Tubs

Product #	Description	Dimensions	Case Pack	Case Cube	Case Weight (lbs.)	Pallet Count
L-6064	64 oz. clear deli bulk pack	6.35" dia x 3.65"	200	4.43	22.26	18
NL-640L	Lid fits 48 oz. & 64 oz. tubs	6.45" dia x 0.45"	200	1.78	9.45	30
L-7080-N	80 oz. natural deli tub	7.43" dia x 4.45"	120	3.47	18.24	10
L-7128-N	128 oz. natural deli tub	7.43" dia x 7.5"	120	4.63	27.93	10
NL-740	Lid fits 80, 96, 112 & 128 oz. tubs	7.45" dia x 0.55"	120	1.40	8.85	25
L-8128-N	128 oz. squat natural deli tub	8.20" dia x 6.00"	90	4.13	21.48	10
L-8160-N	160 oz. natural deli tub	8.20" dia x 7.625"	90	4.83	29.69	10
NL-810-N	Lid fits 112, 128, 144 & 160 oz. tubs	8.20" dia x 0.55"	90	1.22	7.73	30

Deli tub containers are available in white and black by special order only.

## Newspring TETainer® Tamper Evident Containers

Product #	Description	Dimensions	Cs Pack	Cs Cube	Cs Wt (lbs.)	Pallet Count	Ti/Hi
TE08	8 oz. Tamper Evident Natural Container - Bulk	4.2" x 4.2" x 1.5"	210	1.58	9.96	30	15/2
TE12	12 oz. Tamper Evident Natural Container - Bulk	4.2" x 4.2" x 2.4"	420	3.29	20.54	16	8/2
TE16	16 oz. Tamper Evident Natural Container - Bulk	4.2" x 4.2" x 3.0"	420	3.36	22.83	16	8/2
TE32	32 oz. Tamper Evident Natural Container - Bulk	5.125" x 5.125" x 3.875"	210	2.13	16.01	20	10/2
TE48	48 oz. Tamper Evident Natural Container - Bulk	5.375" x 5.375" x 4.5"	240	3.53	23.80	12	6/2
TEL160	8, 12, 16 oz. Tamper Evident Lid - Bulk	4.1" x 4.1" x .325"	840	1.87	16.72	24	8/3
TEL320	32 oz. Tamper Evident Lid - Bulk	5.0" x 5.0" x .325"	420	1.16	10.92	40	10/4
TEL480	48 oz. Tamper Evident Lid - Bulk	5.375" x 5.375" x .325"	480	1.80	15.10	24	12/2

## Clear Advantage™ SmartLock® Bakery/Deli Hingeware – RPET

Product Number	Description	Capacity (fl. oz.)	Dimension (in inches)	Cube	Case Approx Wt.	Packing Sleeve	Case	Cases/ Unit Load
YCASH1050*	RPET Clear 5" Hinged Lid w/1-Cmpt. Tray	11 oz.	5 1/4 x 5 1/4 x 2 1/2	1.75	11.24	3/125	375	36
YCASH1160*	RPET Clear 6" Hinged Lid w/1-Cmpt. Tray	20 oz.	5 3/4 x 6 x 3	2.92	24.16	4/125	500	18
OCASH1120*	RPET Clear Medium Hinged Lid w/1-Cmpt. Tray	49 oz.	8 13/64 x 8 11/32 x 2 29/32	2.14	17.47	2/100	200	24
OCASH1123*	RPET Clear Medium Hinged Lid w/3-Cmpt. Tray	5 oz.(S) - 14 oz. (L)	8 13/64 x 8 11/32 x 2 29/32	2.14	19.48	1/200	200	24
OCASH1110*	RPET Clear Large Hinged Lid w/1-Cmpt. Tray	62 oz.	9 7/32 x 8 7/8 x 2 29/32	2.61	22.70	2/100	200	20
OCASH1124	RPET Clear Medium Hinged Cookie Container	49 oz.	8 13/64 x 8 11/32 x 2 29/32	2.14	19.48	1/200	200	24
OCASH-1030	RPET Clear Medium Hinged Container - Deep	39.6	8 5/8 x 7 3/4 x 3 1/4	2.66	24.70	2/125	250	18
OCASH3025	RPET Clear Large Hinged Strudel Container	44 oz.	6 55/64 x 13 21/34 x 2 1/4	1.69	11.00	2/50	100	27
OCASH9446	RPET Clear 12-Cup Cupcake/Muffin Hinged Container - 2 1/2" Cup Diameter	N/A	13 x 10 1/15 x 3 1/8	2.89	14.00	2/50	100	18
OCASH0970	RPET Clear Hinged 8" x 8" Bakery Container	170 oz.	8 3/4 x 8 1/4 x 3 5/8	2.78	21.02	2/100	200	18
OCASH9140	RPET Clear Hinged 4 Count Muffin Container	N/A.	8 5/8 x 7 1/8 x 3	2.83	24.74	2/126	252	18

\*Part of the EarthChoice® line of RPET containers

\* All products listed above are shipped in 150 count containers/lid combination packs. All products listed above are also available in a 300 count bulk pack by special order only.

## Ultra Pac® Hingeware – PETE

Product Number	Description	Dimension (in inches)	Cube	Case Approx Wt.	Case Pack	Cases/ Unit Load
12481	1-Compartment Hoagie Hinged Container - Black Base	7 3/4 x 3 x 3	2.60	14.00	240	40
11326	Clear Hinged Lunch Box	7 x 6 x 3 1/2	3.59	16.00	150	30
11334	Clear Hinged Sandwich Wedge	6 1/2 x 3 x 3 1/4	2.11	12.00	250	45

## Ultra Pac® Hingeware - PETE

Product Number	Description	Outside Dimensions (in inches)	Case Cube	Case Weight	Case Pack
10817	Clear Single Cell Hingeware	4 x 8 x 2	4.87	17.19	250
10747	Clear Single Cell Hingeware	7 x 7 x 2 1/4	2.92	13.05	150
10777	Clear Single Cell Hingeware	8 x 8 x 2 1/2	2.52	12.90	100
11431	Clear Single Cell Hingeware	4 1/2 x 9 x 2	4.06	14.87	200

**APET Roseware™ Salad Bowl Collection – Combo Packs**

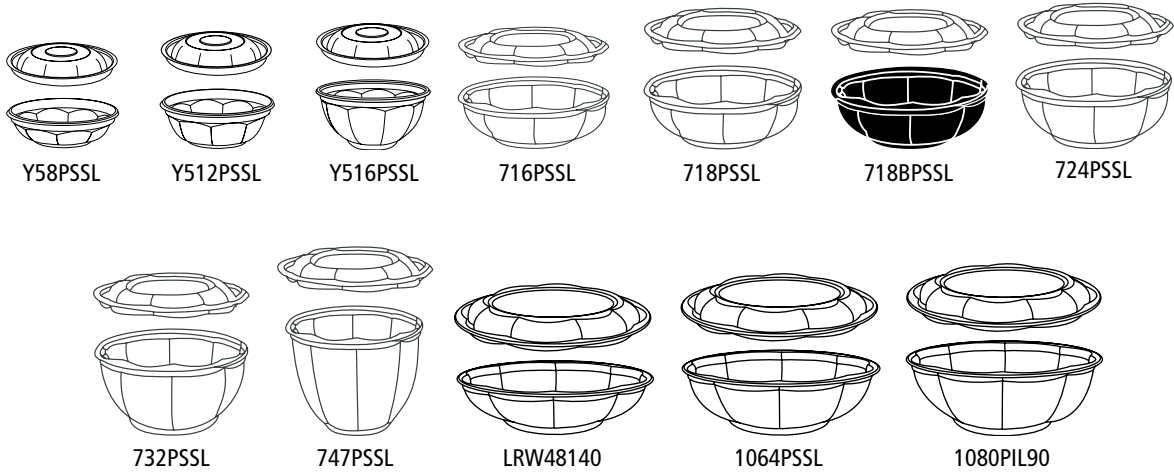

**APET Roseware™ Salad Bowl Collection – Standing & Juice Catcher™**

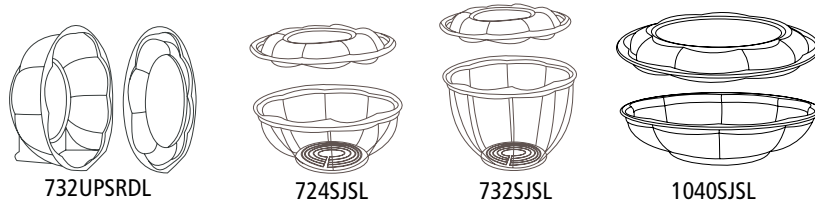

**APET Hinged Lid Deli Containers**

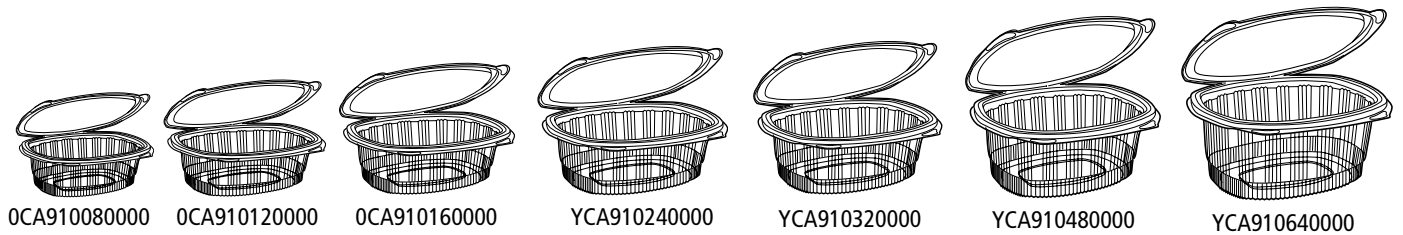

**APET TimeSquare™ Deli Containers & Lids**

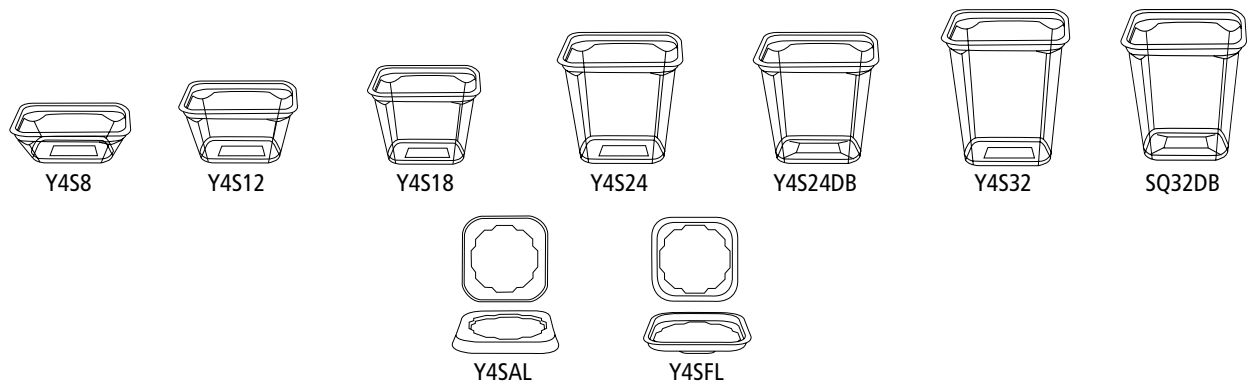

### APET Roseware™ Salad Bowl Collection – Combo Packs

Product Number	Description	Fl. Oz.	Dimensions (in inches)	Case Pack	Case Weight	Case Cube
Y58PSSL	8 oz. Clear Swirl Bowl w/Dome Lid - Combo	8	5 <sup>3</sup> / <sub>8</sub> x 2 <sup>1</sup> / <sub>4</sub>	280 ea.	12.90	4.35
Y512PSSL	12 oz. Clear Swirl Bowl w/Dome Lid - Combo	12	5 <sup>3</sup> / <sub>8</sub> x 2 <sup>3</sup> / <sub>4</sub>	280 ea.	13.69	4.35
Y516PSSL	16 oz. Clear Swirl Bowl w/Dome Lid - Combo	16	5 <sup>3</sup> / <sub>8</sub> x 3 <sup>3</sup> / <sub>8</sub>	280 ea.	14.32	4.35
716PSSL	16 oz. Clear Wide Swirl Bowl w/Dome Lid - Combo	16	6 <sup>3</sup> / <sub>4</sub> x 1 <sup>1</sup> / <sub>2</sub>	300 ea.	21.77	4.34
718PSSL	18 oz. Clear Swirl Bowl w/Dome Lid - Combo	18	6 <sup>3</sup> / <sub>4</sub> x 2	300 ea.	21.98	5.22
718BPSSL	18 oz. Black Swirl Bowl w/Dome Lid - Combo	18	6 <sup>3</sup> / <sub>4</sub> x 2	300 ea.	21.98	5.22
724PSSL	24 oz. Clear Swirl Bowl w/Dome Lid - Combo	24	6 <sup>3</sup> / <sub>4</sub> x 2	300 ea.	23.42	5.22
732PSSL	32 oz. Clear Swirl Bowl w/Dome Lid - Combo	32	6 <sup>3</sup> / <sub>4</sub> x 2	300 ea.	26.87	5.22
747PSSL	48 oz. Clear Swirl Bowl w/Dome Lid - Combo	48	6 <sup>3</sup> / <sub>4</sub> x 4 <sup>3</sup> / <sub>8</sub>	150 ea.	16.37	3.88
1040PSSL	40 oz. Clear Swirl Bowl w/Dome Lid - Combo	40	9 <sup>7</sup> / <sub>8</sub> x 2	100 ea.	16.11	3.43
LRW48140	48 oz. Clear Roseware® Bowl w/Dome Lid - Combo	48	9 <sup>7</sup> / <sub>8</sub> x 2	140 ea.	21.86	6.31
1064PSSL	64 oz. Clear Swirl Bowl w/Dome Lid - Combo	64	9 <sup>7</sup> / <sub>8</sub> x 3	120 ea.	16.90	3.43
1080PIL90	80 oz. Clear Swirl Bowl w/Flat Lid - Combo	80	9 <sup>7</sup> / <sub>8</sub> x 3 <sup>1</sup> / <sub>2</sub>	120 ea.	18.78	3.43
1096PSSL	96 oz. Clear Swirl Bowl w/Dome Lid - Combo	96	9 <sup>7</sup> / <sub>8</sub> x 4	120 ea.	20.91	4.54
<b>Lid</b>						
7SL	7" Swirl Lid	--	7	600	22.34	5.22

### APET Roseware® Salad Bowl Collection – Standing & Juice Catcher™

Product Number	Description	Fl. Oz.	Dimensions (in inches)	Case Pack	Case Weight	Case Cube
732UPSRDL	Standing Swirl w/Dome Lid - Combo	32	6.83 x 3.22	150 ea.	11.17	3.88
724SJSJL	Swirl Container w/Juice Trap - Combo	24	6.83 x 2.63	300 ea.	24.42	5.22
732SJSJL	Swirl Container w/Juice Trap - Combo	32	6.83 x 3.13	300 ea.	26.87	5.22
1040SJSJL	Swirl Container w/Juice Trap - Combo	40	9.75 x 1.88	100 ea.	16.11	3.43

### APET Hinged Lid Deli Containers

Product Number	Description	Dimensions (in inches)	Case Pack	Case Weight	Case Cube
OCA910080000	8 oz Clear Hinged Container	4.92 x 5.87 x 1.32	200	10.30	2.40
OCA910120000	12 oz Clear Hinged Container	4.92 x 5.87 x 1.89	200	10.94	2.40
OCA910160000	16 oz Clear Hinged Container	4.92 x 5.87 x 2.48	200	11.09	2.40
YCA910240000	24 oz Clear Hinged Container	6.00 x 7.28 x 2.28	280	16.76	4.59
YCA910320000	32 oz Clear Hinged Container	6.00 x 7.28 x 2.99	280	17.16	4.59
YCA910480000	48 oz Clear Hinged Container	7.35 x 8.96 x 2.86	190	22.60	4.12
YCA910640000	64 oz Clear Hinged Container	7.35 x 8.96 x 3.72	190	22.60	4.12

### APET TimeSquare™ Deli Containers & Lids

Product Number	Description	Top Out	Fl. Oz.	Vert. Depth	Case Pack	Case Weight	Case Cube
Y4S8	Clear Square Deli Container	4 <sup>1</sup> / <sub>16</sub> x 4 <sup>1</sup> / <sub>16</sub>	8	1 <sup>3</sup> / <sub>8</sub>	1000	22.87	3.20
Y4S12	Clear Square Deli Container	4 <sup>1</sup> / <sub>16</sub> x 4 <sup>1</sup> / <sub>16</sub>	12	2	1000	27.08	3.20
Y4618	Clear Square Deli Container	4 <sup>1</sup> / <sub>16</sub> x 4 <sup>1</sup> / <sub>16</sub>	16	2 <sup>7</sup> / <sub>8</sub>	750	26.87	3.10
Y4S24	Clear Square Deli Container	4 <sup>1</sup> / <sub>16</sub> x 4 <sup>1</sup> / <sub>16</sub>	24	4 <sup>1</sup> / <sub>4</sub>	500	26.49	2.50
Y4S24DB	Clear Square Deli Container - Domed Bottom	4 <sup>1</sup> / <sub>16</sub> x 4 <sup>1</sup> / <sub>16</sub>	24	3 <sup>3</sup> / <sub>8</sub>	500	26.99	2.50
Y4S32	Clear Square Deli Container	4 <sup>1</sup> / <sub>16</sub> x 4 <sup>1</sup> / <sub>16</sub>	32	5 <sup>1</sup> / <sub>8</sub>	500	30.31	2.50
<b>Lids</b>							
Y4SAL	4" Square Snap Lid	--	--	--	1000	19.35	3.10
Y4SFL	4" Square Flat Recessed Lid	--	--	--	1000	18.12	3.10

**APET 6" Square Shelf Savers® – Bulk**

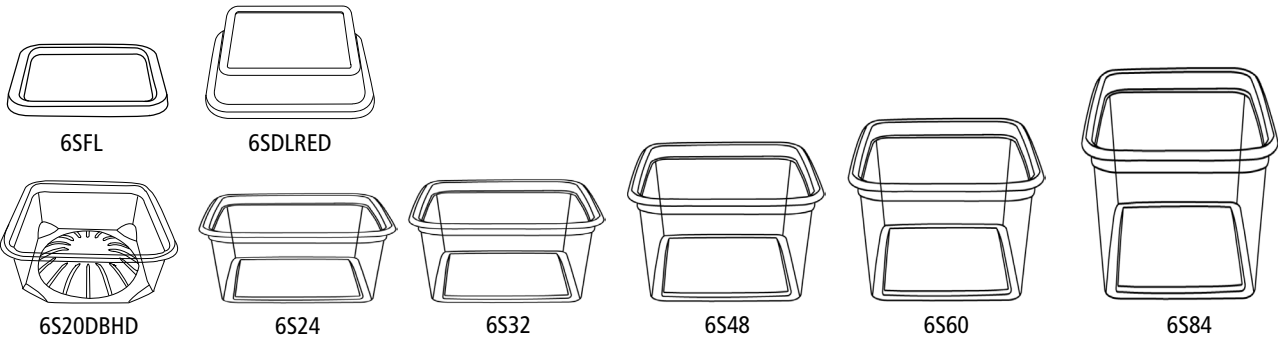

**APET 6" Square Compartmented Shelf Savers® – Bulk**

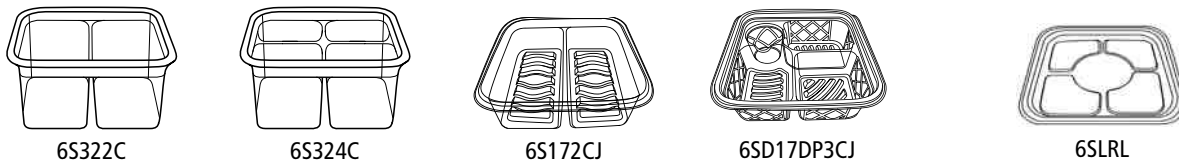

**APET 6" Square Shelf Savers® – Bulk**

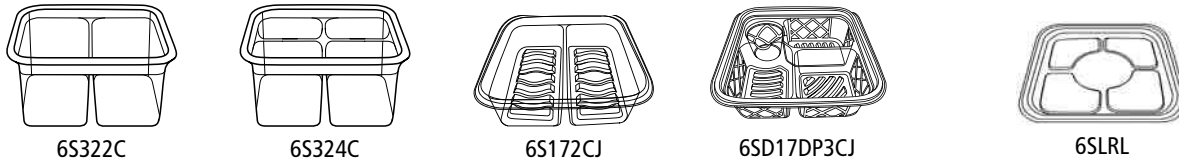

**Grandstand™ Hinged Bowls - PETE**



**Flip 'n Stack™ – PETE**

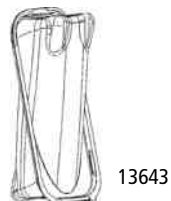

### APET 6" Square Shelf Savers® – Bulk

Product Number	Description	Outside Dimensions (in inches)	Case Cube	Case Weight	Case Pack
<b>6" Square Lids</b>					
6SFL	6" Square Flat Lid	6 1/4	5.20	20.00	600
6SDLRED	6" Square Red Dome Lid	6 1/4 x 6 1/4 x 1 5/8	5.20	28.00	600
<b>6" Square Containers</b>					
6S20DBHD	20 oz. Square Clear Container Dome Bottom	6 1/8 x 6 1/8 x 2	4.60	21.00	300
6S24	24 oz. Square Clear Container	6 1/8 x 6 1/8 x 2	4.60	17.00	300
6S32	32 oz. Square Clear Container	6 1/8 x 6 1/8 x 2 1/2	4.60	17.00	300
6S48	48 oz. Square Clear Container	6 1/8 x 6 1/8 x 3 3/4	5.20	23.00	300
6S60	60 oz. Square Clear Container	6 1/8 x 6 1/8 x 4 3/4	5.20	28.00	300
6S84	84 oz. Square Clear Container	6 1/8 x 6 1/8 x 6 5/8	5.20	40.00	270

### APET 6" Square Compartmented Shelf Savers® – Bulk

Product Number	Description	Outside Dimensions (in inches)	Case Cube	Case Weight	Case Pack
<b>6" Square Compartmented Containers</b>					
6S322C	32 oz. Square Clear 2-Compartment Container	6 1/8 x 6 1/8 x 2 1/2	4.60	19.00	300
6S324C	32 oz. Square Clear 4-Compartment Container	6 1/8 x 6 1/8 x 2 1/2	4.60	19.00	300
<b>6" Square Platter Lid</b>					
6SLRL	6" Square Leak Resistant Lid	6 1/4	4.60	13.00	400
<b>6" Square Compartmented Containers</b>					
6S172CJ	17 oz. Square Clear Container 2 Cells w/Juice Trap	6 1/8 x 6 1/8 x 1 5/8	4.60	14.00	300
6SD17DP3CJ	17 oz. Square Clear Diamond Container, Dip Cup, 3 Cells w/Juice Trap	6 1/8 x 6 1/8 x 1 5/8	4.20	19.00	400

### APET 8" Square Shelf Savers® – Bulk

Product Number	Description	Outside Dimensions (in inches)	Case Cube	Case Weight	Case Pack
<b>8" Square Lids</b>					
8SNL	8" Square Flat Lid	8 3/4	3.00	13.00	200
<b>8" Square Containers</b>					
8S40	40 oz. Square Clear Container	8 5/8 x 8 5/8 x 1 9/16	3.50	17.00	200
8S64	64 oz. Square Clear Container	8 5/8 x 8 5/8 x 2 3/8	3.00	10.00	100
8S99	99 oz. Square Clear Container	8 5/8 x 8 5/8 x 3 1/2	2.50	13.00	100
8S104	104 oz. Square Clear Container	8 5/8 x 8 5/8 x 3 7/8	2.50	13.00	100
8S115	115 oz. Square Clear Container	8 5/8 x 8 5/8 x 4	3.00	14.00	100
8S128	128 oz. Square Clear Container	8 5/8 x 8 5/8 x 4 1/2	3.00	15.00	100

### Grandstand™ Hinged Bowls - PETE

Product Number	Description	Outside Dimensions (in inches)	Case Cube	Case Weight	Case Pack
12761	18 oz. Clear w/Black Base Hinged Bowl	7 1/4 x 2 3/4 x 1 3/4	2.80	14.00	150
12807	18 oz. Clear Lid Hinged Bowl	7 1/4 x 2 3/4 x 1 3/4	2.82	13.00	150
12808	28 oz. Clear Hinged Bowl	7 1/4 x 3 1/2 x 2 1/2	2.83	13.00	150
12809	35 oz. Clear Hinged Bowl	7 1/4 x 4 x 3	2.82	13.65	150
12811	54 oz. Clear Hinged Bowl	8 x 4 3/8 x 3 1/4	3.58	16.00	130

### Flip 'n Stack™ – PETE

Product Number	Description	Dimension (in inches)	Case Cube	Case Approx Wt.	Case Pack	Cases/ Unit Load
13643	Clear Flip 'n Stack™ Container	8 1/2 x 3 3/8 x 2 1/2	2.59	13.70	240	40

**Reynolds® Octagons - PETE**

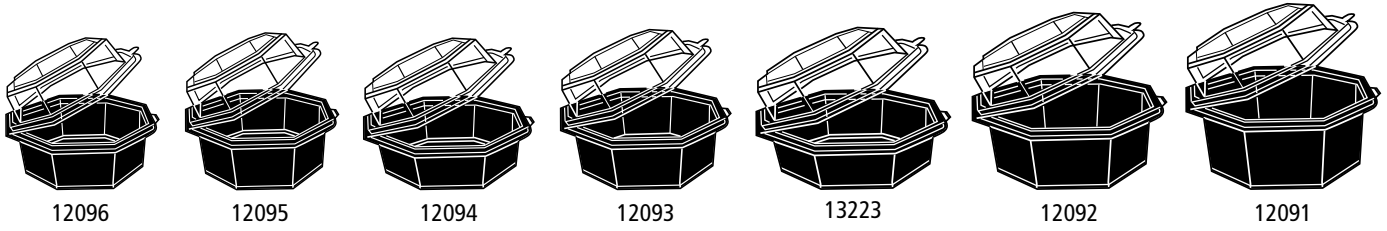

**Reynolds® Ultra Pac® Herb Clamshells - PETE**

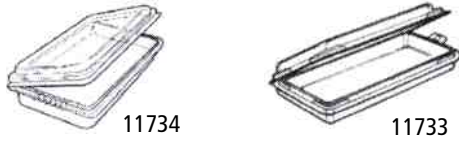

**Reynolds® Sho-Bowls® - PETE**

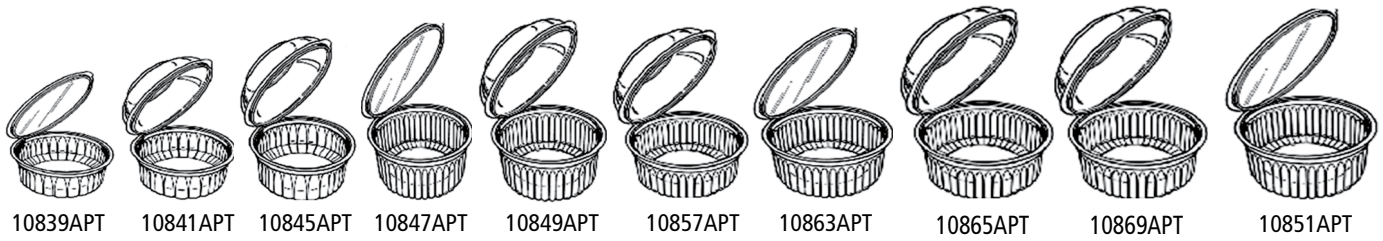

**Reynolds® Octagons - PETE**

Product Number	Description	Color	Dimensions (in inches)		Vert. Depth	Case		Case Pack	Cases/ Unit Load
			Top Out	Base Height		Cube	Weight		
12096	16 oz. Octagonal Clamshell	Clear Lid/Black Base	6 1/2	1 1/4	2 5/8	2.18	12.00	150	42
12095	19 oz. Octagonal Clamshell	Clear Lid/Black Base	6 1/2	1 1/2	3 1/4	2.18	12.00	150	42
12094	22 oz. Octagonal Clamshell	Clear Lid/Black Base	7 3/4	1 1/8	2 1/2	3.03	15.00	150	36
12093	29 oz. Octagonal Clamshell	Clear Lid/Black Base	7 3/4	1 1/2	3 1/4	3.11	17.00	150	36
13223	30 oz. Octagonal Clamshell	Clear Lid/Black Base	9 1/8	1 1/8	2	4.51	20.00	150	16
12092	33 oz. Octagonal Clamshell	Clear Lid/Black Base	9 1/8	1 1/8	2 1/2	4.40	21.00	150	16
13173	8/8/8/4 oz. Hinged Bowl - 4 Compartment	Clear Lid/Black Base	9 1/8	1 1/8	2 1/2	4.51	21.00	150	16
12091	44 oz. Octagonal Hinged Bowl	Clear Lid/Black Base	9 1/8	1 1/2	3 1/4	4.40	24.00	150	16

**Reynolds® Ultra Pac® Herb Clamshells - PETE**

Product Number	Description	Color	Dimensions (in inches)		Case Cube	Case Weight	Case Pack	Cases/ Unit Load
			Top Out	Base Height				
11734	Herb Clamshell	Clear	4 x 7	1 1/8	2.00	10.00	200	50
11733	Herb Clamshell w/Tab	Clear	4 x 7	1 1/8	2.00	10.00	200	50

**Reynolds® Sho-Bowls® - PETE**

Product Number	Description	Color	Dimensions (in inches)		Vert. Depth	Case		Case Pack	Cases/ Unit Load
			Top Out	Base Height		Cube	Weight		
10839APT	8 oz. Bowl w/Flat Lid	Clear	4 5/8	1 1/4	1 3/4	2.71	8.65	250	40
10841APT	8 oz. Bowl w/Dome Lid	Clear	4 5/8	1 1/4	2 3/4	2.58	8.00	250	40
10845APT	12 oz. Bowl w/Dome Lid	Clear	4 5/8	1 3/4	3 3/8	2.62	10.00	250	40
10847APT	16 oz. Bowl w/Flat Lid	Clear	4 5/8	2 1/2	3	2.62	11.00	250	40
10849APT	16 oz. Bowl w/Dome Lid	Clear	4 5/8	2 1/2	4 1/4	2.54	11.00	250	40
10857APT	16 oz. Bowl w/Dome Lid	Clear	6 7/8	1	2 3/4	2.88	10.00	150	35
10863APT	32 oz. Bowl w/Flat Lid	Clear	6 7/8	2 1/4	2 3/4	2.82	12.00	150	35
10865APT	32 oz. Bowl w/Dome Lid	Clear	6 7/8	2 1/4	4 1/8	2.75	12.00	150	35
10869APT	39 oz. Bowl w/Dome Lid	Clear	6 7/8	2 3/4	4 1/2	2.82	14.10	150	35
10853APT	56 oz. Bowl w/Ribbed Dome Lid	Clear	7 1/2	2 1/4	4 7/8	3.54	17.00	150	30
10851APT	56 oz. Bowl w/Flat Lid	Clear	7 1/2	3 1/8	3 5/8	3.43	16.00	150	30





---

# Food Prep Packaging

---





Product Number	Description	Page	Product Number	Description	Page
1012-30	1/2 SIZE METAL STEAM TABLE COVER.....	E3	Y6050XH	FULL SIZE STEAM TABLE PAN.....	E3
1012-30E	1/2 SIZE METAL STEAM TABLE COVER - COATED .....	E3	Y6050XXH	FULL SIZE STEAM TABLE PAN.....	E3
610M	REYNOLDS® METRO LINE™ ALUM FOIL ROLL - 12" X 500' - STANDARD.....E3	E3	Y6110XH	FULL SIZE STEAM TABLE .....	E3
610P	REYNOLDS® ALUMINUM FOIL ROLL - 12" X 500' - STANDARD .....	E3	Y6112H	1/2 SIZE STEAM TABLE.....	E3
611	REYNOLDS® ALUMINUM FOIL ROLL - 12" X 1000' - STANDARD .....	E3	Y6112XH	1/2 SIZE STEAM TABLE .....	E3
611M	REYNOLDS® METRO LINE™ ALUM FOIL ROLL - 12" X 1000' - STANDARD...E5	E5	Y6112XHE	1/2 SIZE STEAM TABLE - PROTECTIVE COATED INSIDE.....	E3
613	REYNOLDS® ALUMINUM FOIL ROLL - 15" X 1000' - STANDARD .....	E3	Y6120XH	FULL SIZE STEAM TABLE .....	E3
614	REYNOLDS® ALUMINUM FOIL ROLL - 18" X 500' - STANDARD .....	E3	Y6132H	1/2 SIZE STEAM TABLE - DEEP .....	E3
614M	REYNOLDS® METRO LINE™ ALUM FOIL ROLL - 18" X 500' - STANDARD ...E5	E5	Y6132L	1/2 SIZE STEAM TABLE - DEEP .....	E3
615	REYNOLDS® ALUMINUM FOIL ROLL - 18" X 1000' - STANDARD .....	E3	Y6132XH	1/2 SIZE STEAM TABLE - DEEP .....	E3
615M	REYNOLDS® METRO LINE™ ALUM FOIL ROLL - 18" X 1000' - STANDARD...E5	E5	Y6132XHE	1/2 SIZE STEAM TABLE - PROTECTIVE COATED INSIDE - DEEP .....	E3
620	REYNOLDS® ALUMINUM FOIL ROLL - 12" X 500' - HEAVY DUTY.....	E3	YM63-3521	#50 NATURAL PULPEX™ FOOD TRAY .....	E9
622	REYNOLDS® ALUMINUM FOIL ROLL - 15" X 500' - HEAVY DUTY.....	E3	YM63-3522	#100 PULPEX™ FOOD TRAY .....	E9
624M	REYNOLDS® METRO LINE™ ALUM FOIL ROLL - 18" X 500' - HEAVY DUTY ...E5	E5			
624	REYNOLDS® ALUMINUM FOIL ROLL - 18" X 500' - HEAVY DUTY.....	E3			
624R	REYNOLDS® FOIL ROLL FROM 100% RECYCLED ALUM - 18" X 500' - HEAVY DUTY .....	E3			
625	REYNOLDS® ALUMINUM FOIL ROLL - 18" X 1000' - HEAVY DUTY .....	E3			
625M	REYNOLDS® METRO LINE™ ALUM FOIL ROLL - 18" X 1000' - HEAVY DUTY ...E5	E5			
6264XH	BULK FOOD STEAM TABLE .....	E3			
627	REYNOLDS® ALUMINUM FOIL ROLL - 24" X 1000' - HEAVY DUTY.....	E3			
632	REYNOLDS® ALUMINUM FOIL ROLL - 18" X 500' - EXTRA HEAVY DUTY ...E3	E3			
633	REYNOLDS® ALUMINUM FOIL ROLL - 24" X 500' - EXTRA HEAVY DUTY ...E3	E3			
6342-60	1/2 SIZE STEAM TABLE .....	E3			
650C	REYNOLDS® ALUMINUM CONVENIENCE SIZE ROLL - 12' X 250' - STANDARD ...E3	E3			
667C	REYNOLDS® ALUMINUM CONVENIENCE SIZE ROLL - 18' X 50' - HEAVY DUTY ...E3	E3			
694	REYNOLDS® ALUMINUM NON-STICK FOIL - 18" X 350'.....	E3			
701	REYNOLDS® ALUMINUM INTERFOLDED SHEETS - 8" X 10.75" - PLAIN .....	E5			
7012	REYNOLDS® CUSHION FOLD SAND WRAPS COMBO - 10.5" X 14" - PLAIN.....	E5			
7046	REYNOLDS® ALL PURPOSE GAUGE SAND WRAPS - 9" X 10.75" - PLAIN .....	E5			
710	REYNOLDS® ALUMINUM INTERFOLDED SHEETS - 9" X 10.75" - PLAIN .....	E5			
711	REYNOLDS® ALUMINUM INTERFOLDED SHEETS - 9" X 10.75" - PLAIN .....	E5			
712	REYNOLDS® ALUMINUM INTERFOLDED SHEETS - 9" X 10.75" - GOLD .....	E5			
720	REYNOLDS® ALUMINUM INTERFOLDED SHEETS - 12" X 10.75" - PLAIN.....	E5			
720M	REYNOLDS® METRO LINE™ ALUM INTERFOLDED SHEETS - 12" X 10.75" - PLAIN ...E5	E5			
721	REYNOLDS® ALUMINUM INTERFOLDED SHEETS - 12" X 10.75" - PLAIN .....	E5			
721M	REYNOLDS® METRO LINE™ ALUM INTERFOLDED SHEETS - 12" X 10.75" - PLAIN .....	E5			
721R	REYNOLDS® ALUM INTERFOLDED SHEETS FROM 100% RECYCLED - 12" X 10.75" - PLAIN.....	E5			
726FS	REYNOLDS® ALUMINUM INTERFOLDED SHEETS - 9" X 10.75" - RED STRIPE .....	E5			
727	REYNOLDS® ALUMINUM INTERFOLDED SHEETS - 9" X 10.75" - GREEN STRIPE.....	E5			
728	REYNOLDS® ALUMINUM INTERFOLDED SHEETS - 9" X 10.75" - BLUE CROSS HATCH .....	E5			
7511	REYNOLDS® METRO LINE™ INTERFOLDED SHEETS - 10.5" X 13" - GOLDLINE .....	E5			
7512	REYNOLDS® METRO LINE™ INTERFOLDED SHEETS - 10.5" X 13" - REDLINE .....	E5			
7513	REYNOLDS® METRO LINE™ INTERFOLDED SHEETS - 10.5" X 13" - BLUELINE .....	E5			
7523	REYNOLDS® METRO LINE™ INTERFOLDED SHEETS - 10.5" X 13" - PLAIN.....	E5			
7524	REYNOLDS® METRO LINE™ INTERFOLDED SHEETS - 14" X 10.5" - PLAIN.....	E5			
7528	REYNOLDS® METRO LINE™ INTERFOLDED SHEETS - 10.5" X 14" - HAMBURGER .....	E5			
7529	REYNOLDS® METRO LINE™ INTERFOLDED SHEETS - 10.5" X 14" - CHEESEBURGER.....	E5			
7534SR	REYNOLDS® 14" X 16" PLAIN CUSHION-FOLD RELEASE COATING FOIL WRAP .....	E5			
7535	REYNOLDS® METRO LINE™ CUSHION FOLD SAND WRAPS COMBO - 10.5" X 14" .....	E5			
900BRF	REYNOLDS® FOODSERVICE FILM CONTINUOUS ROLLS 12" X 1000' .....	E7			
904	REYNOLDS® FOODSERVICE FILM CONTINUOUS ROLLS 18" X 1000' .....	E7			
905	REYNOLDS® FOODSERVICE FILM CONTINUOUS ROLLS 12" X 3000' .....	E7			
910	REYNOLDS® FOODSERVICE FILM CONTINUOUS ROLLS 12" X 2000' .....	E7			
910CG	REYNOLDS® FOODSERVICE FILM CUTTER GARD® GRIT EDGE 12" X 2000' .....	E7			
910M	REYNOLDS® FOODSERVICE FILM METRO LINE™ 12" X 2000' .....	E7			
910SC	REYNOLDS® FOODSERVICE FILM EASY GLIDE™ SLIDE CUTTER 12" X 2000' .....	E7			
912BRF	REYNOLDS® FOODSERVICE FILM CONTINUOUS ROLLS 15" X 2000' .....	E7			
914	REYNOLDS® FOODSERVICE FILM CONTINUOUS ROLLS 18" X 2000' .....	E7			
914CG	REYNOLDS® FOODSERVICE FILM CUTTER GARD® GRIT EDGE 18" X 2000' .....	E7			
914M	REYNOLDS® FOODSERVICE FILM METRO LINE™ 18" X 2000' .....	E7			
914SC	REYNOLDS® FOODSERVICE FILM EASY GLIDE™ SLIDE CUTTER 18" X 2000' .....	E7			
915	REYNOLDS® FOODSERVICE FILM CONTINUOUS ROLLS 18" X 3000' .....	E7			
916	REYNOLDS® FOODSERVICE FILM CONTINUOUS ROLLS 24" X 2000' .....	E7			
916M	REYNOLDS® FOODSERVICE FILM METRO LINE™ 24" X 2000' .....	E7			
916SC	REYNOLDS® FOODSERVICE FILM EASY GLIDE™ SLIDE CUTTER 24" X 2000' .....	E7			
920R	REYNOLDS® FOODSERVICE FILM PRE-SIZED SHEETS ON A ROLL 6" X 5' .....	E7			
924	REYNOLDS® FOODSERVICE FILM PRE-SIZED SHEETS ON A ROLL 9" X 9' .....	E7			
926	REYNOLDS® FOODSERVICE FILM PRE-SIZED SHEETS ON A ROLL 10" X 10' .....	E7			
930S	REYNOLDS® FOODSERVICE FILM PRE-SIZED SHEETS ON A ROLL 12" X 12' .....	E7			
937S	REYNOLDS® FOODSERVICE FILM PRE-SIZED SHEETS ON A ROLL 14" X 14' .....	E7			
939S	REYNOLDS® FOODSERVICE FILM PRE-SIZED SHEETS ON A ROLL 24" X 18' .....	E7			
954	REYNOLDS® FOODSERVICE FILM PRE-SIZED SHEETS ON A ROLL 15" X 15' .....	E7			
964	REYNOLDS® FOODSERVICE FILM OVEN COOKING BAGS 19" X 23.5' .....	E7			
996	REYNOLDS® FOODSERVICE FILM PACER® FOODSERVICE FILM (1 MILE OF FILM) 12" X 5280' .....	E7			
997	REYNOLDS® FOODSERVICE FILM PACER® FOODSERVICE FILM (1 MILE OF FILM) 18" X 5280' .....	E7			
M63-3523	#200 PULPEX™ FOOD TRAY .....	E9			
M63-3524Y	#300 PULPEX™ FOOD TRAY .....	E9			
P9350	PLASTIC DOME FOR BULK FOOD PANS.....	E3			
PCS 01205	12.25" PRESSWARE® CLASSIC STONEWARE™ PIZZA TRAY .....	E9			
PCS 01305	13" PRESSWARE® CLASSIC STONEWARE™ PIZZA TRAY .....	E9			
PCS 01505	14" PRESSWARE® CLASSIC STONEWARE™ PIZZA TRAY .....	E9			
PCS 01705	16" PRESSWARE® CLASSIC STONEWARE™ PIZZA TRAY .....	E9			
PCS 0806	7" PRESSWARE® CLASSIC STONEWARE™ PIZZA TRAY .....	E9			
PEP 01305	12" PRESSWARE® EBONY PREMIER® PIZZA TRAY .....	E9			
PEP 01505	14" PRESSWARE® EBONY PREMIER® PIZZA TRAY .....	E9			
PEP 01705	16" PRESSWARE® EBONY PREMIER® PIZZA TRAY .....	E9			
PEP 0806	7" PRESSWARE® EBONY PREMIER® PIZZA TRAY .....	E9			
PSP 01106CS	11.5" PRESSWARE® CLASSIC STONEWARE™ PIZZA TRAY .....	E9			
W80	REYNOLDS® METRO LINE™ CUSHION FOLD SANDWICH WRAPS - 12" X 14" - PLAIN.....	E5			
Y1120-45	FULL SIZE METAL STEAM TABLE COVER .....	E3			
Y6012XH	HALF SIZE STEAM TABLE PAN - SHALLOW.....	E3			

## Aluminum Steam Tables — Full Size

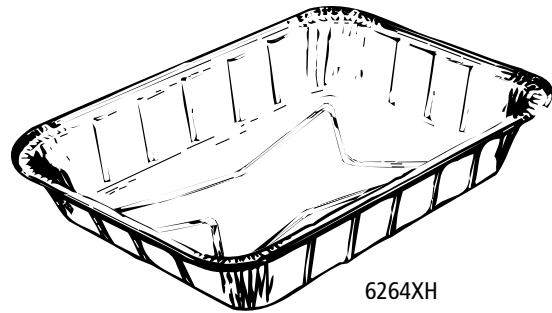
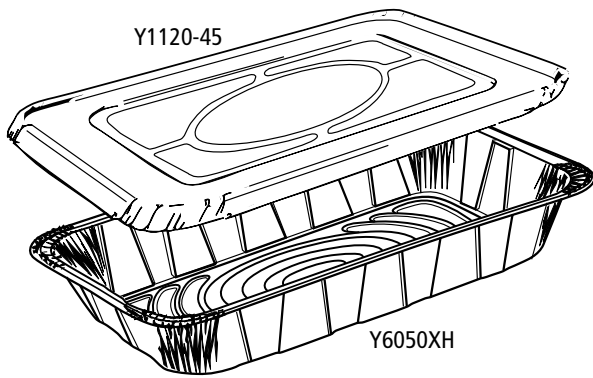

## Aluminum Steam Tables — Half Size

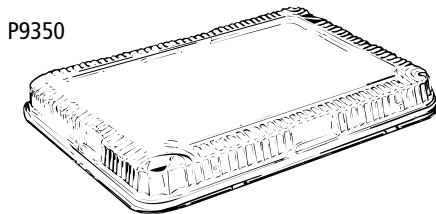

1012-30, 1012-30E

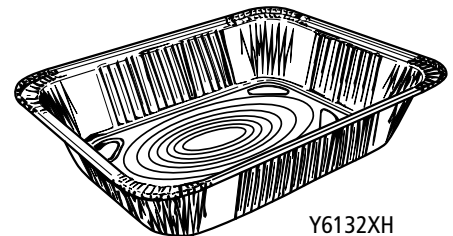
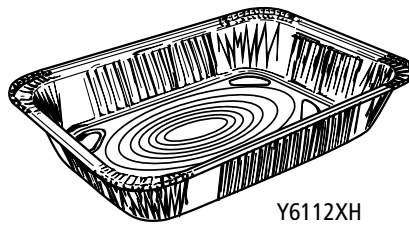
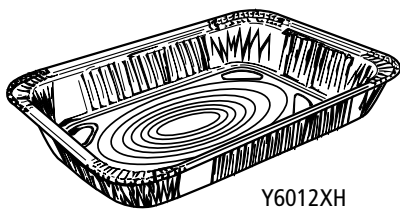
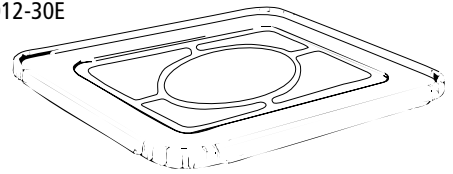

## Reynolds® Aluminum Foil Rolls

### Standard Aluminum Foil



### Heavy-Duty Aluminum Foil



### Recycled Aluminum Foil



### Extra Heavy-Duty Aluminum Foil



### Aluminum Steam Tables — Full Size

Product Number	Description	Capacity (fl. oz.)	Top Out	Dimensions (in inches)		Vert. Depth	Case Cube	Case Weight	Rim Style	Case Pack	Cases/ Unit Load
				Top In	Bottom						
Y6110XH	Full Size Pan - Shallow	174.7	20 3/4 x 12 13/16	19 9/16 x 11 5/8	18 5/8 x 10 11/16	1 11/16	1.60	10.95	F.C.	40	40
Y6120XH	Full Size Pan - Medium	228.0	20 3/4 x 12 13/16	19 9/16 x 11 5/8	18 5/8 x 10	2 3/16	1.82	11.79	F.C.	40	32
Y6050XH	Full Size Pan - Deep	346.0	20 3/4 x 12 13/16	19 9/16 x 11 5/8	17 19/32 x 9 21/32	3 3/8	1.81	13.30	F.C.	40	32
Y6050XXH	Full Size Pan - Deep	346.0	20 3/4 x 12 13/16	19 9/16 x 11 5/8	17 19/32 x 9 21/32	3 3/8	1.94	15.24	F.C.	40	24
Y1120-45	Metal Cover for 6050, 6120 & 6110	--	20 13/16 x 12 7/8	20 5/16 x 12 3/8	17 13/32 x 9 15/32	5/8	1.39	11.52	I.V.C.F.	80	30
6264XH*	Bulk Food Pan	173.0	14 1/2 x 10 5/8	13 1/2 x 9 5/8	12 5/16 x 8 7/16	2 15/16	2.39	14.53	F.C.	100	

### Aluminum Steam Tables — Half Size

Product Number	Description	Capacity (fl. oz.)	Top Out	Dimensions (in inches)		Vert. Depth	Case Cube	Case Weight	Rim Style	Case Pack	Cases/ Unit Load
				Top In	Bottom						
Y6012XH	Half Size Pan - Shallow	79.5	12 3/4 x 10 3/8	11 3/4 x 9 3/8	10 13/16 x 8 7/16	1 11/16	1.95	9.12	V.C.	100	32
Y6112H	Half Size Pan - Medium	104.0	12 3/4 x 10 3/8	11 3/4 x 9 3/8	10 1/2 x 8 1/8	2 3/16	2.01	9.98	V.C.	100	32
Y6112XH	Half Size Pan - Medium/Heavy	104.0	12 3/4 x 10 3/8	11 3/4 x 9 3/8	10 1/2 x 8 1/8	2 3/16	2.01	10.44	V.C.	100	32
Y6112XHE	Half Size Pan - Medium Protective Coated Inside	104.0	12 3/4 x 10 3/8	11 3/4 x 9 3/8	10 1/2 x 8 1/8	2 3/16	2.01	10.76	V.C.	100	32
Y6132L	Half Size Pan - Deep	120.0	12 3/4 x 10 3/8	11 3/4 x 9 3/8	10 1/4 x 7 7/8	2 9/16	2.01	9.45	V.C.	100	32
Y6132H	Half Size Pan - Deep	120.0	12 3/4 x 10 3/8	11 3/4 x 9 3/8	10 1/4 x 7 7/8	2 9/16	2.01	10.41	F.C.	100	32
Y6132XH	Half Size Pan - Deep	120.0	12 3/4 x 10 3/8	11 3/4 x 9 3/8	10 1/4 x 7 7/8	2 9/16	2.01	10.89	F.C.	100	32
Y6132XHE	Half Size Pan - Deep Protective Coated Inside	120.0	12 3/4 x 10 3/8	11 3/4 x 9 3/8	10 1/4 x 7 7/8	2 9/16	2.01	11.23	F.C.	100	32
6342-60	Half Size Pan - Extra Deep	187.0	12 3/4 x 10 3/8	11 3/4 x 9 3/8	9 1/2 x 7 1/8	4 3/16	2.94	20.16	R.F.C.		
P9350	Clear Cover for Half Size Pans	--	13 1/8 x 10 3/4	12 7/8 x 10 1/2	11 3/4 x 9 3/8	3/4	3.49	9.00	--		
1012-30	Metal Cover Half Size for 6112, 6132 & 6342	--	12 13/16 x 10 7/16	12 5/16 x 9 15/16	10 1/16 x 7 23/32	5/8	0.92	5.76	I.V.C.		
1012-30E	Metal Cover Coated for 6112, 6132 & 6342	--	12 13/16 x 10 7/16	12 5/16 x 9 15/16	10 1/16 x 7 23/32	5/8	0.92	5.84	I.V.C.		

### Reynolds® Aluminum Foil Rolls

Product Number	Dimensions	Case		Cases Per Layer	Layers Per Skid	Cases Per Skid	Rolls Per Case	Cases/ Unit Load
		Cube	Weight					
<b>Standard Aluminum Foil</b>								
610P*	12" x 500'		3.53	8	31	248		
611	12" x 1000'	0.15	9.34	27	8	216	1	216
613	15" x 1000'	0.23	11.78	20	7	140	1	140
614	18" x 500'	0.23	7.44	20	8	160	1	160
615	18" x 1000'	0.24	13.90	20	8	160	1	160
<b>Heavy-Duty Aluminum Foil</b>								
620	12" x 500'	0.16	7.02	27	8	216	1	216
622	15" x 500'	0.23	8.88	20	7	140	1	140
624	18" x 500'	0.23	10.41	20	8	160	1	160
625	18" x 1000'	0.29	19.99	18	7	126	1	126
627	24" x 1000'	0.36	26.80	12	6	72	1	72
<b>Extra Heavy-Duty Aluminum Foil</b>								
632	18" x 500'	0.27	15.65	18	7	126	1	126
633	24" x 500'	0.36	21.02	12	6	72	1	72
<b>Convenience Size Foil Rolls</b>								
650C	12" x 250' - Standard	0.79	7.90	16	7	112	35	112
667C	18" x 50' - Heavy-Duty	0.78	23.60	20	3	60	20	60
<b>Aluminum Foil From 100% Recycled Aluminum</b>								
624R	18" x 500' - Heavy-Duty	0.23	10.41	20	8	160	1	160
<b>Non-Stick Foil</b>								
694	18" x 350'	0.23	7.86	20	8	160	1	160

\*Item may not be available in all regions. Please contact your Pactiv sales representative for order minimum and lead time.

## Reynolds® Aluminum Interfolded Sheets



## Reynolds® Metro Line™ Aluminum Foil Rolls

Metro Line™ Aluminum Foil - Standard



Metro Line™ Aluminum Foil - Heavy duty



## Reynolds® Metro Line™ Interfolded Sheets



## Reynolds® Cushion-Fold® Foil Wrap



## Reynolds® Aluminum Interfolded Sheets

Product Number	Dimensions	Color	Sheets Per Box	Boxes Per Case	Case Cube	Weight	Cases Per Layer	Layers Per Skid	Cases/ Unit Load
<b>Interfolded Sheets - Self Dispensing Box</b>									
701	8" x 10 3/4"	Plain	500	6	0.62	14.10	16	6	96
710	9" x 10 3/4"	Plain	200	12	1.07	13.80	10	6	60
711	9" x 10 3/4"	Plain	500	6	0.68	15.90	16	6	96
712	9" x 10 3/4"	Gold	200	12	1.16	14.30	10	6	60
720	12" x 10 3/4"	Plain	200	12	1.39	22.20	10	6	60
721	12" x 10 3/4"	Plain	500	6	1.10	26.00	12	6	72
<b>Striped Interfolded Sheets</b>									
726FS	9" x 10 3/4"	Red Stripe	500	6	0.69	16.00	16	6	96
727	9" x 10 3/4"	Long Green Stripe	3000	6		14.22	16	6	96
728	9" x 10 3/4"	Blue Cross Hatch	3000	6		14.22	16	6	96
<b>Aluminum Foil Interfolded Sheets From 100% Recycled Aluminum</b>									
721R	12" x 10 3/4"	Plain	500	6	1.10	26.00	12	6	72

## Reynolds® Metro Line™ Aluminum Foil Rolls

Product Number	Description	Case Cube	Weight	Cases Per Layer	Layers Per Skid	Cases Per Skid	Rolls Per Case	Cases/ Unit Load
<b>Metro Line™ Foil - Standard</b>								
610M	12" x 500'		3.53	8	31	248		
611M	12" x 1000'	0.15	8.51	27	8	216	1	216
614M	18" x 500'	0.23	6.81	20	8	160	1	160
615M	18" x 1000'	0.24	13.90	20	8	160	1	160
<b>Metro Line™ Foil - Heavy Duty</b>								
624M	18" x 500'	0.23	9.46	20	8	160	1	160
625M	18" x 1000'	0.29	18.08	18	7	126	1	126

## Reynolds® Metro Line™ Interfolded Sheets

Product Number	Dimensions	Color	Sheets Per Box	Boxes Per Case	Case Cube	Weight	Cases Per Layer	Layers Per Skid	Cases/ Unit Load
720M	12" x 10 3/4"	Plain	200	12	1.39	18.86	13	6	78
721M	12" x 10 3/4"	Plain	500	6	1.10	21.83	12	6	72

## Reynolds® Cushion-Fold® Foil Wrap

Product Number	Dimensions	Sheets Per Box	Boxes Per Case	Case Cube	Weight	Cases Per Layer	Layers Per Skid	Cases/ Unit Load
7511	10 1/2" x 13" Goldline Sandwich Wraps	500	5	.53	21.00	11	7	77
7512	10 1/2" x 13" Redline Sandwich Wraps	500	5	.53	21.00	11	7	77
7513	10 1/2" x 13" Blueline Sandwich Wraps	500	5	.53	21.00	11	7	77
7523	10 1/2" x 13" Plain Sandwich Wraps	500	5	.23	21.00	11	7	77
7524	14" x 10 1/2" Plain Sandwich Wraps	500	5	.58	22.00	10	7	70
7528	10 1/2" x 14" Hamburger Sandwich Wraps	500	5	.58	22.00	10	7	70
7529	10 1/2" x 14" Cheeseburger Sandwich Wraps	500	5	.58	22.00	10	7	70
7534	14" x 16" Plain Sandwich Wraps	500	5	.44	14.00	9	13	117
7535*	10 1/2" x 14" Cushion Fold Sandwich Wraps Combo	500	5	.58	22.00	10	7	70
W80*	12" x 12" Unprinted Cushion Fold Sandwich Wraps	500	5	.54	21.50	12	5	60
7012*	12" x 12" Unprinted Cushion Fold Sandwich Wraps	500	5	.54	21.66	9	7	63
7046*	9" x 10 3/4" All Purpose Gauge Sandwich Wraps	500	5	.56	14.22	16	6	96
7534SR	14" x 16" Plain - Release Coating	500	2	.39	13.50	9	13	117

\*Item may not be available in all regions. Please contact your Pactiv sales representative for order minimum and lead time.

# Reynolds® Foodservice Film

## Continuous Length Rolls



## Easy Glide™ Slide Cutter



## Cutter Gard® Grit Edge



## Metro Line™



# Reynolds® Foodservice Film





**Reynolds® Foodservice Film**

Product Number	Dimensions	Case Cube	Case Weight	Cases Per Layer	Layers Per Skid	Cases Per Skid	Rolls Per Carton	Cases/ Unit Load
<b>Continuous Length Rolls</b>								
900BFR	12" x 1000'	0.27	3.40	56	6	336	1	336
910	12" x 2000'	0.27	5.80	56	6	336	1	336
905	12" x 3000'	0.27	8.20	56	6	336	1	336
912BRF	15" x 2000'	0.33	7.10	56	4	224	1	224
904	18" x 1000'	0.39	5.00	56	4	224	1	224
914	18" x 2000'	0.39	8.50	56	4	224	1	224
915	18" x 3000'	0.39	12.10	56	4	224	1	224
916	24" x 2000'	0.50	11.30	56	2	112	1	112
<b>Easy Glide™ Slide Cutter</b>								
910SC	12" x 2000'	0.27	5.80	56	6	336	1	336
914SC	18" x 2000'	0.39	8.20	56	4	224	1	224
916SC	24" x 2000'	0.59	10.70	56	2	112	1	112
<b>Cutter Gard® Grit Edge</b>								
910CG	12" x 2000'	0.27	5.80	56	6	336	1	336
914CG	18" x 2000'	0.39	8.20	56	4	224	1	224
<b>Metro Line™</b>								
910M	12" x 2000'	0.27	5.40	56	6	336	1	336
914M	18" x 2000'	0.39	7.70	56	4	224	1	224
916M	24" x 2000'	0.59	9.90	56	2	112	1	112
<b>Pacer® Foodservice Film (1 Mile of Film)</b>								
996	12" x 5280'	0.80	16.80	20	4	80	1	80
997	18" x 5280'	1.10	25.30	20	4	80	1	80

Please contact Reynolds customer service for information regarding dispensers

**Reynolds® Foodservice Film**

Number	Sheets Per Dimensions	Rolls Cube	Rolls Weight	Cases/ Per Layer	Per Skid	Per Skid	Carton	Per Carton	Unit Load
<b>Pre-Sized Sheets-on-a-Roll</b>									
920R	6" x 5"	0.10	3.00	72	8	576	3000	1	576
924	9" x 9"	0.20	4.00	72	6	432	2100	1	432
926	10" x 10"	0.20	5.00	72	6	432	1900	1	432
930S	12" x 12"	0.20	6.00	72	6	432	1600	1	432
937S	14" x 14"	0.30	6.00	72	4	288	1200	1	288
954	15" x 15"	0.30	6.00	72	4	288	1100	1	288
939S	24" x 18"	0.40	8.00	72	2	144	700	1	144
Product Number	Dimensions	Case Cube	Case Weight	Cases Per Layer	Layers Per Skid	Cases Per Skid	Sheets Per Roll	Rolls Per Carton	Cases/ Unit Load
<b>Oven Cooking Bags</b>									
964	19" x 23 1/2"	0.30	5.00	16	12	192	150	1	192

## Molded Fiber Pulpex® Food Trays

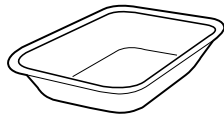

YM63-3521

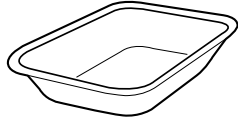

YM63-3522

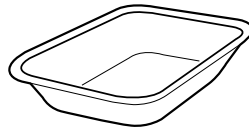

M63-3523

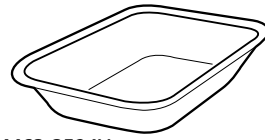

M63-3524Y

## Pressware® Classic Stoneware™ & Ebony Premier® Ovenable Paperboard Pizza Trays

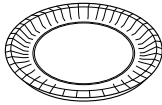

PCS 0806

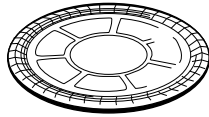

PCS 01305

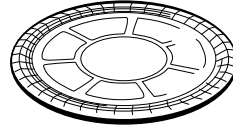

PCS 01505

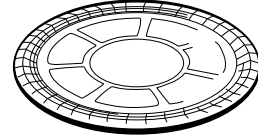

PCS 01705

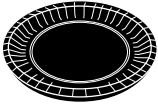

PEP 0806

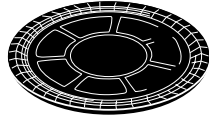

PEP 01305

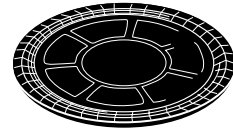

PEP 01505

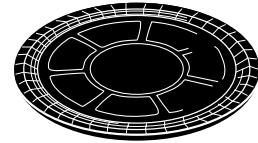

PEP 01705

## Molded Fiber Pulpex® Food Trays

Product Number	Description	Capacity (fl. oz.)	Dimensions (in inches)			Vert. Depth	Cube	Case Approx. Wt	Case Pack
			Top Out	Top In	Bottom				
YM63-3521	#50 Natural Food Tray	8.0	5 3/4 x 4	5 1/6 x 3 9/16	3 x 1 5/8	1 1/4	1.87	17.80	920
YM63-3522	#100 Natural Food Tray	11.8	6 3/4 x 4 3/4	6 1/4 x 4 1/4	4 3/8 x 2 3/8	1 1/4	2.00	19.64	840
M63-3523	#200 Natural Food Tray	16.0	7 1/2 x 5 1/2	7 x 5	4 5/8 x 2 9/16	1 1/2	3.17	31.05	1000
M63-3524Y	#300 Natural Food Tray	32.0	9 1/8 x 6 7/8	8 5/8 x 6 3/8	5 5/8 x 3 3/8	1 3/4	2.71	24.84	500

## Pressware® Classic Stoneware™ & Ebony Premier® Ovenable Paperboard Pizza Trays

Product Number	Description	Capacity (fl. oz.)	Dimensions (in inches)			Vert. Depth	Cube	Case Approx. Wt.	Case Pack
			Top Out	Top In	Bottom				
PCS 0806	8" Round tray for 7" Pizza	18.0	8 1/4	7 1/2	7	13/16	1.99	17.13	350
PEP 0806	8" Round tray (black) for 7" Pizza	18.0	8 1/4	7 1/2	7	13/16	1.99	17.60	350
PSP 01106CS	11.5" Round tray for 10" Pizza	38.4	11 5/8	11 3/16	10 1/2	3/4	1.55	23.10	250
PCS 01205	12.25" Round tray for 12" Pizza	30.6	12 1/4	11 3/4	10 9/64	19/32	1.20	23.90	250
PCS 01305	13" Round tray for 12" Pizza	38.0	13 3/32	12 11/32	11 15/16	19/32	2.33	25.31	250
PEP 01305	13" Round tray (black) for 12" Pizza	38.0	13 3/32	12 11/32	11 15/16	19/32	2.33	32.31	250
PCS 01505	15" Round tray for 14" Pizza	52.0	15 7/16	14 13/16	14 3/16	19/32	2.77	38.71	250
PEP 01505	15" Round tray (black) for 14" Pizza	52.0	15 7/16	14 13/16	14 3/16	19/32	2.77	42.48	250
PCS 01705	16.5" Round tray for 16" Pizza	57.7	16 1/2	15 7/8	14 3/4	5/8	1.25	26.24	150
PEP 01705	16.5" Round tray (black) for 16" Pizza	57.7	16 1/2	15 7/8	14 3/4	5/8	1.79	29.23	150

Do Not Use **PRESSWARE®** Containers In Toaster Ovens.

### Guidelines for the use of **PRESSWARE®** dual-ovenable pizza trays

1. Only the pizza and the paper tray should go in the oven.
2. Only use regular, full size gas or electric home ovens.
3. Pre-heat the oven to the set temperature BEFORE putting the pizza in the oven.
4. The oven set temperature may be up to 425° F.
5. The maximum time for baking is 30 minutes.
6. Always place the pizza tray on the middle rack position.
7. Bake only one pizza at a time.
8. Use oven mitts or pads to remove the baked pizza from the oven.



# Home Meal Replacement (HMR) Packaging





Product Number	Description	Page
6026-30	1 LB OBLONG ENTREE .....	F5
6036-30	2-COMPARTMENT OBLONG HAMBURGER .....	F5
6236-30	2-COMPARTMENT DEEP OBLONG HAMBURGER .....	F5
6278XHY	LARGE CROWN OVAL ROASTER .....	F3
6298XHY	LARGE CROWN RECTANGULAR ROASTER .....	F3
6326-30	DEEP OBLONG .....	F5
664WP	SQUARE CAKE PACKAGE W/DOME .....	F3
6707WPSFG	OVAL FOIL BASE W/DOME LID W/FOG GARD COATING .....	F3
6708WPSFG	SINGLE SERVE BLACK/GOLD FOIL BASE W/FOG GARD DOME LID .....	F3
6708WPFZFG	SINGLE SERVE BLACK/GOLD FOIL BASE W/FOG GARD FLAT LID .....	F3
6711WP	LG BLACK EXTERIOR/GOLD FOIL INTERIOR BASE W/DOME LID .....	F3
69107-30	2-COMPARTMENT DEEP OBLONG HOT DOG .....	F5
69310TP	3-COMPARTMENT OBLONG W/BOARD COVER .....	F3
7089TP	4-COMPARTMENT OBLONG W/ BOARD COVER .....	F3
788TP	MEDIUM OBLONG W/ BOARD COVER .....	F3
C18 0615	CLEAR DOME FOR PRESSWARE® 0615 ROUND DELI BOWL .....	F9
C18 5613	CLEAR DOME FOR PRESSWARE 5613 CONTAINER .....	F9, F11
C18 5613R	CLEAR DOME FOR PRESSWARE 5613R CONTAINER .....	F9, F11
C18 5615	CLEAR DOME FOR PRESSWARE 4512, 5615 CONTAINERS .....	F9, F11
C18 5710	CLEAR HIGH DOME FOR PRESSWARE 5710, 5713 CONTAINERS .....	F9, F11
C18 5713	CLEAR LOW DOME FOR PRESSWARE 5710, 5713 CONTAINERS .....	F9, F11
C18 5713R	CLEAR DOME FOR PRESSWARE 5713R, 5716R CONTAINERS .....	F9, F11
C18 6815	CLEAR DOME FOR PRESSWARE 6815 CONTAINER .....	F9, F11
C18 6816	CLEAR DOME FOR PRESSWARE 6816 CONTAINER .....	F9, F11
CN8-4616	16 OZ. BLACK CLEARVIEW MEALMASTER TRAY .....	F7
CN8-4624	24 OZ. BLACK CLEARVIEW MEALMASTER TRAY .....	F7
CN8-4624HD	CLEARVIEW MEDIUM DOME LID W/FOG GARD COATING .....	F7
CN8-462SD	CLEARVIEW MEDIUM FLAT LID W/FOG GARD COATING .....	F7
CN8-4632	32 OZ. BLACK CLEARVIEW MEALMASTER TRAY .....	F7
CN8-4636	36 OZ. BLACK CLEARVIEW MEALMASTER 1 COMPARTMENT TRAY .....	F9
CN8-4637	21 OZ., 10 OZ. BLACK CLEARVIEW MEALMASTER 2 COMPARTMENT TRAY .....	F9
CN8-4638	21 OZ., 4 1/2 OZ., 4 1/2 OZ. BLACK CLEARVIEW MEALMASTER 3 COMP. TRAY .....	F9
CN8-463SD	CLEARVIEW LARGE FLAT LID W/FOG GARD™ COATING .....	F9
CN8-466HD	CLEARVIEW LARGE 1 COMPARTMENT DOME LID W/FOG GARD COATING .....	F9
CN8-467HD	CLEARVIEW LARGE 2 COMPARTMENT DOME LID W/FOG GARD COATING .....	F9
CN8-468HD	CLEARVIEW LARGE 3 COMPARTMENT DOME LID W/FOG GARD COATING .....	F9
CN8-5008	8 OZ BLACK CLEARVIEW MICROMAX® CONTAINER .....	F5
CN8-5012	12 OZ. BLACK CLEARVIEW MICROMAX CONTAINER .....	F5
CN8-5016	16 OZ. BLACK CLEARVIEW MICROMAX 16 OZ. CONTAINER .....	F5
CN8-5024	24 OZ. BLACK CLEARVIEW MICROMAX CONTAINER .....	F5
CN8-5032	32 OZ. BLACK CLEARVIEW MICROMAX CONTAINER .....	F5
CN8-5100	CLEAR SNAP-ON LID - 8 & 12 OZ. CONTAINERS .....	F5
CN8-5200	CLEAR SNAP-ON LID -16, 24 & 32 OZ. CONTAINERS .....	F5
CN8-5512	12 OZ CLEARVIEW MICROMAX BLACK OVAL BASE .....	F7
CN8-5516	16 OZ CLEARVIEW MICROMAX BLACK OVAL BASE .....	F7
CN8-5524	24 OZ CLEARVIEW MICROMAX BLACK OVAL BASE .....	F7
CN8-3002	CLEARVIEW MEALMASTER SMALL CHICKEN BARN™ CONTAINER (2PC) .....	F7
CNC-3016	CLEARVIEW MEALMASTER LARGE CHICKEN BARN CONTAINER .....	F7
NC-333	32 OZ NEWSPRING VERSATAINER WHITE 3-CMPT. RECT. BASE & CLEAR LID .....	F15
NC-333-B	32 OZ NEWSPRING VERSATAINER BLACK 3-CMPT. RECT. BASE & CLEAR LID .....	F15
NC-626	26 OZ NEWSPRING VERSATAINER WHITE SQUARE BASE & CLEAR LID .....	F13
NC-626-B	26 OZ NEWSPRING VERSATAINER BLACK SQUARE BASE & CLEAR LID .....	F13
NC-636	36 OZ NEWSPRING VERSATAINER WHITE SQUARE BASE & CLEAR LID .....	F13
NC-636-B	36 OZ NEWSPRING VERSATAINER BLACK SQUARE BASE & CLEAR LID .....	F13
NC-718	16 OZ NEWSPRING VERSATAINER WHITE ROUND BASE & CLEAR LID .....	F13
NC-718-B	16 OZ NEWSPRING VERSATAINER BLACK ROUND BASE & CLEAR LID .....	F13
NC-723	24 OZ NEWSPRING VERSATAINER WHITE ROUND BASE & CLEAR LID .....	F13
NC-723-B	24 OZ NEWSPRING VERSATAINER BLACK ROUND BASE & CLEAR LID .....	F13
NC-729	32 OZ NEWSPRING VERSATAINER WHITE ROUND BASE & CLEAR LID .....	F13
NC-729-B	32 OZ NEWSPRING VERSATAINER BLACK ROUND BASE & CLEAR LID .....	F13
NC-737	35 OZ NEWSPRING VERSATAINER WHITE ROUND BASE & CLEAR LID .....	F13
NC-737-B	35 OZ NEWSPRING VERSATAINER BLACK ROUND BASE & CLEAR LID .....	F13
NC-8168	16 OZ NEWSPRING VERSATAINER WHITE RECTANGULAR BASE & CLEAR LID .....	F15
NC-8168-B	16 OZ NEWSPRING VERSATAINER BLACK RECTANGULAR BASE & CLEAR LID .....	F15
NC-8168-BV	16 OZ NEWSPRING VERSATAINER BLACK RECT. BASE & CLEAR LID - VENTED .....	F15
NC-818	12 OZ NEWSPRING VERSATAINER WHITE RECTANGULAR BASE & CLEAR LID .....	F15
NC-818-B	12 OZ NEWSPRING VERSATAINER BLACK RECTANGULAR BASE & CLEAR LID .....	F15
NC-8288	30 OZ NEWSPRING VERSATAINER WHITE 2-CMPT. RECT. BASE & CLEAR LID .....	F15
NC-8288-B	30 OZ NEWSPRING VERSATAINER BLACK 2-CMPT. RECT. BASE & CLEAR LID .....	F15
NC-838	24 OZ NEWSPRING VERSATAINER WHITE RECTANGULAR BASE & CLEAR LID .....	F15
NC-838-B	24 OZ NEWSPRING VERSATAINER BLACK RECTANGULAR BASE & CLEAR LID .....	F15
NC-838-BV	24 OZ NEWSPRING VERSATAINER BLACK RECT. BASE & CLEAR LID - VENTED .....	F15
NC-868	28 OZ NEWSPRING VERSATAINER WHITE RECTANGULAR BASE & CLEAR LID .....	F15
NC-868-B	28 OZ NEWSPRING VERSATAINER BLACK RECTANGULAR BASE & CLEAR LID .....	F15
NC-888	38 OZ NEWSPRING VERSATAINER WHITE RECTANGULAR BASE & CLEAR LID .....	F15
NC-888-B	38 OZ NEWSPRING VERSATAINER BLACK RECTANGULAR BASE & CLEAR LID .....	F15
NC-888-BV	38 OZ NEWSPRING VERSATAINER BLACK RECT. BASE & CLEAR LID - VENTED .....	F15
NC-9388	48 OZ NEWSPRING VERSATAINER 3 CMPT WHITE ROUND BASE & CLEAR LID .....	F13
NC-9388-B	48 OZ NEWSPRING VERSATAINER 3 CMPT BLACK ROUND BASE & CLEAR LID .....	F13
NC-948	48 OZ NEWSPRING VERSATAINER WHITE ROUND BASE & CLEAR LID .....	F13
NC-948-B	48 OZ NEWSPRING VERSATAINER BLACK ROUND BASE & CLEAR LID .....	F13
NC-948-BV	48 OZ NEWSPRING VERSATAINER BLACK ROUND BASE & VENTED CLEAR LID .....	F13
NC-989	58 OZ NEWSPRING VERSATAINER WHITE RECTANGULAR BASE & CLEAR LID .....	F15
NC-989-B	58 OZ NEWSPRING VERSATAINER BLACK RECTANGULAR BASE & CLEAR LID .....	F15
NC-989-BV	58 OZ NEWSPRING VERSATAINER BLACK RECT. BASE & CLEAR LID - VENTED .....	F15
OC-06	6 OZ NEWSPRING VERSATAINER WHITE OVAL BASE & CLEAR LID .....	F13
OC-06-B	6 OZ NEWSPRING VERSATAINER BLACK OVAL BASE & CLEAR LID .....	F13
OC-08	8 OZ NEWSPRING VERSATAINER WHITE OVAL BASE & CLEAR LID .....	F13
OC-08-B	8 OZ NEWSPRING VERSATAINER BLACK OVAL BASE & CLEAR LID .....	F13
OC-12	12 OZ NEWSPRING VERSATAINER WHITE OVAL BASE & CLEAR LID .....	F13
OC-12-B	12 OZ NEWSPRING VERSATAINER BLACK OVAL BASE & CLEAR LID .....	F13
OC-16	16 OZ NEWSPRING VERSATAINER WHITE OVAL BASE & CLEAR LID .....	F13
OC-16-B	16 OZ NEWSPRING VERSATAINER BLACK OVAL BASE & CLEAR LID .....	F13

Product Number	Description	Page
OC-24	24 OZ NEWSPRING VERSATAINER WHITE OVAL BASE & CLEAR LID .....	F13
OC-24-B	24 OZ NEWSPRING VERSATAINER BLACK OVAL BASE & CLEAR LID .....	F13
OC-32	32 OZ NEWSPRING VERSATAINER WHITE OVAL BASE & CLEAR LID .....	F13
OC-32-B	32 OZ NEWSPRING VERSATAINER BLACK OVAL BASE & CLEAR LID .....	F13
PCS 0412	PRESSWARE® CLASSIC STONWARE® ROUND TRAY .....	F9
PCS 4403	PRESSWARE CLASSIC STONWARE SQUARE TRAY (UNCOATED) .....	F9
PCS 4412	PRESSWARE CLASSIC STONWARE SQUARE TRAY .....	F9
PCS 4413	PRESSWARE CLASSIC STONWARE SQUARE TRAY .....	F9
PCS 4512	PRESSWARE CLASSIC STONWARE OBLONG TRAY .....	F9
PCS 5611R	PRESSWARE CLASSIC STONWARE OBLONG TRAY (ROUNDED CORNERS) .....	F9
PCS 5613	PRESSWARE CLASSIC STONWARE OBLONG TRAY .....	F9
PCS 5613RR1	PRESSWARE CLASSIC STONWARE OBLONG TRAY (ROUNDED CORNERS) .....	F9
PCS 5615	PRESSWARE CLASSIC STONWARE OBLONG TRAY .....	F9
PCS 5710	PRESSWARE CLASSIC STONWARE OBLONG TRAY .....	F9
PCS 5713	PRESSWARE CLASSIC STONWARE OBLONG TRAY .....	F9
PCS 5713R	PRESSWARE CLASSIC STONWARE SHALLOW OBLONG TRAY (ROUNDED CORNERS) .....	F9
PCS 5715R	PRESSWARE CLASSIC STONWARE OBLONG TRAY (ROUNDED CORNERS) .....	F9
PCS 5716R	PRESSWARE CLASSIC STONWARE DEEP OBLONG TRAY (ROUNDED CORNERS) .....	F9
PCS 5811R	PRESSWARE CLASSIC STONWARE OBLONG TRAY (ROUNDED CORNERS) .....	F9
PCS 6815	PRESSWARE CLASSIC STONWARE OBLONG TRAY .....	F9
PCS 6816	PRESSWARE CLASSIC STONWARE OBLONG TRAY .....	F9
PCS 7014	PRESSWARE CLASSIC STONWARE OBLONG TRAY .....	F9
PCS 81116	PRESSWARE CLASSIC STONWARE OBLONG TRAY .....	F9
PEP 0813H	PRESSWARE EBONY PREMIER SHALLOW OVAL DELI TRAY .....	F9
PEP 0816H	PRESSWARE EBONY PREMIER DEEP OVAL DELI TRAY .....	F9
PEP 4512	PRESSWARE EBONY PREMIER OBLONG TRAY .....	F11
PEP 5613RR1	PRESSWARE EBONY PREMIER OBLONG TRAY (ROUNDED CORNERS) .....	F11
PEP 5615	PRESSWARE EBONY PREMIER OBLONG TRAY .....	F11
PEP 5713R	PRESSWARE EBONY PREMIER SHALLOW OBL TRAY (ROUNDED CORNERS) .....	F9, F11
PEP 5715R	PRESSWARE EBONY PREMIER OBLONG TRAY (ROUNDED CORNERS) .....	F9
PEP 5716R	PRESSWARE EBONY PREMIER DEEP OBLONG TRAY (ROUNDED CORNERS) .....	F9
PEP 6815	PRESSWARE EBONY PREMIER OBLONG TRAY .....	F11
PEP 6816	PRESSWARE EBONY PREMIER OBLONG TRAY .....	F11
PEP 7014	PRESSWARE EBONY PREMIER OBLONG TRAY .....	F11
PSP 0615EP	PRESSWARE EBONY PREMIER ROUND DELI BOWL .....	F9
SAB0508	8 OZ. BLACK SQUARE BOWL BASE .....	F11
SAB0512	12 OZ. BLACK SQUARE BOWL BASE .....	F11
SAB0516	16 OZ. BLACK SQUARE BOWL BASE .....	F11
SAB0724	24 OZ. BLACK SQUARE BOWL BASE .....	F11
SAB0732	32 OZ. BLACK SQUARE BOWL BASE .....	F11
SAB0948	48 OZ. BLACK SQUARE BOWL BASE .....	F11
SAB0964	64 OZ. BLACK SQUARE BOWL BASE .....	F11
SAC0508	8 OZ. CLEAR SQUARE BOWL BASE .....	F11
SAC0512	12 OZ. CLEAR SQUARE BOWL BASE .....	F11
SAC0516	16 OZ. CLEAR SQUARE BOWL BASE .....	F11
SAC0724	24 OZ. CLEAR SQUARE BOWL BASE .....	F11
SAC0732	32 OZ. CLEAR SQUARE BOWL BASE .....	F11
SAC0948	48 OZ. CLEAR SQUARE BOWL BASE .....	F11
SAC0964	64 OZ. CLEAR SQUARE BOWL BASE .....	F11
SACLD07	24, 32 OZ. CLEAR DOME LID .....	F11
SACLD09	48, 64 OZ. CLEAR DOME LID .....	F11
SACLF07	24, 32 OZ. CLEAR FLAT LID .....	F11
SACLF09	48, 64 OZ. CLEAR FLAT LID .....	F11
SACLI07T	7.375" INSERT FOR SQUARE SALAD CONTAINERS .....	F11
SACLI09T	9" INSERT FOR SQUARE SALAD CONTAINERS .....	F11
SR1-0708	QUART SIZE HEFTY® FAST-PAK® UTILITY BAG .....	F5
SR1-1111	GALLON SIZE HEFTY FAST-PAK UTILITY BAG .....	F5
Y6710WPSFG	SM BLACK /GOLD FOIL BASE W/FOG GARD DOME LID .....	F3
Y6710WPFZFG	SM BLACK /GOLD FOIL BASE W/FOG GARD FLAT LID .....	F3
Y7139TP	3-COMPARTMENT OBLONG W/ BOARD COVER .....	F3
Y7139TPP	3-COMPARTMENT OBLONG W/ OVENABLE PAPER COVER .....	F3
Y7239TP	3-COMPARTMENT OBLONG W/ BOARD COVER .....	F3
YC18-5300	CLEAR SNAP-ON LID FOR 2 & 3 COMP. CONTAINERS .....	F5
YC18 D714	CLEAR DOME FOR PRESSWARE 7014 CONTAINER .....	F9, F11
YCN806000000	TFPP SMARTLOCK 1-CMPT. HINGED SANDWICH CONTAINER .....	F15
YCN808010000	TFPP SMARTLOCK 1-CMPT. MEDIUM HINGED CONTAINER .....	F15
YCN808030000	TFPP SMARTLOCK 3-CMPT. MEDIUM HINGED CONTAINER .....	F15
YCN809010000	TFPP SMARTLOCK 1-CMPT. LARGE HINGED CONTAINER .....	F15
YCN809030000	TFPP SMARTLOCK 3-CMPT. LARGE HINGED CONTAINER .....	F15
YCN809610000	TFPP SMARTLOCK 1-CMPT. HINGED HOAGIE CONTAINER .....	F15
YCN809620000	TFPP SMARTLOCK 2-CMPT. HINGED HOAGIE CONTAINER .....	F15
YCN8-4608	8 OZ. BLACK CLEARVIEW MEALMASTER™ TRAY .....	F7
YCN8-460HD	CLEARVIEW SMALL DOME LID W/FOG GARD™ COATING .....	F7
YCN8-4612	12 OZ. BLACK CLEARVIEW MEALMASTER TRAY .....	F7
YCN8-5101D	CLEAR SNAP-ON DOME - 8 & 12 OZ. CONTAINERS W/FOG-GARD .....	F5
YCN8-5201D	R SNAP-ON DOME -16, 24, & 32 OZ. CONTAINERS W/FOG-GARD .....	F5
YCN8-5301D	CLEAR SNAP-ON DOME LID FOR 2 & 3 CMPT CONTAINERS W/FOG-GARD .....	F5
YCN8-5420	CLEARVIEW MICROMAX BLACK 2-CMPT. OBLONG CONTAINER .....	F5
YCN8-5430	CLEARVIEW MICROMAX BLACK 3-CMPT. OBLONG CONTAINER .....	F5
YCN8-5501D	CLEAR SNAP-ON LID FOR 12 & 16 OZ. OVALS .....	F7
YCN8-5502D	CLEAR SNAP-ON LID FOR 24 OZ. OVALS .....	F7
YCN8-6516D	16 OZ BASE W/CLEAR LID W/FOG-GARD COATING - COMBO PACK .....	F7
YCN8-6516DZ	CLEARVIEW MEALMASTER SMALL CHICKEN BARN™ CONTAINER (4PC) .....	F7
YCN8-6516DZ	CLEARVIEW MEALMASTER MEDIUM CHICKEN BARN™ CONTAINER .....	F7
YCN8-6516DZ	X-LARGE ROASTER BASE W/DOME LID W/FOG GARD™ COATING .....	F7
YCN8-6516DZ	COMBO PACK MED. ROASTER BASE W/DOME LID W/FOG GARD COATING .....	F7
YCN8-6516DZ	MED. ROASTER BASE W/DOME LID W/FOG GARD™ COATING - W/ ZIPSEAL™ .....	F7
YCN8-6516DZ	SMALL ROASTER BASE W/DOME LID W/FOG GARD™ COATING .....	F7
YCN8-6509D	COMBO PACK - HALF SLAB RIB CONTAINER W/DOME LID .....	F7
YCN8-6514D	COMBO PACK - FULL SLAB RIB CONTAINER W/DOME LID .....	F7
YCN8-6509D	HANDLED CHICKEN ROASTER CONTAINER W/FOG GARD™ DOME .....	F7
YSACLD05	8, 12, 16 OZ. CLEAR DOME LID .....	F11
YSACLF05	8, 12, 16 OZ. CLEAR FLAT LID .....	F11

## Aluminum Carry-Out — Window-Pack® and Thrift-Pack® Combos

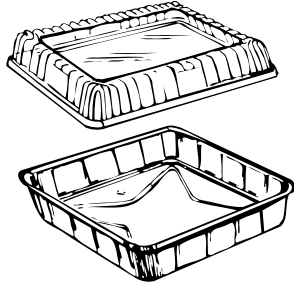

664WP

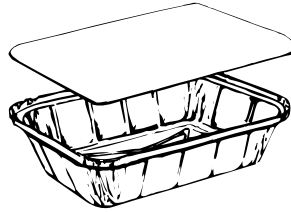

788TP

## Aluminum Classic Carry-Out® Packaging

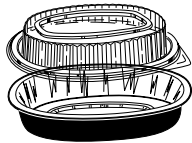

6707WPSFG

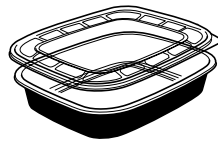

6708WPZFG

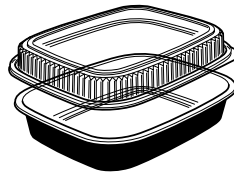

Y6710WPSFG

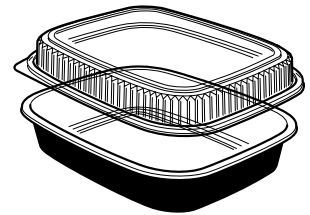

6711WP

## Aluminum Rack 'N' Roast® Roasters



6278XHY

## Nutrition Products

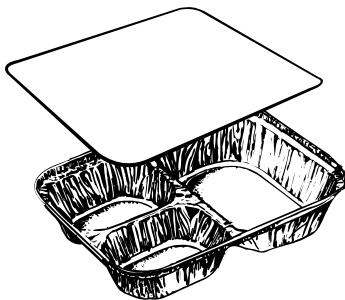

Y7139TP



Y7239TP



### Aluminum Carry-Out — Window-Pack® and Thrift-Pack® Combos

Product Number	Container Description	Capacity (fl. oz.)	Dimensions (in inches)	Cover Description	Case		Case Pack	Cases/ Unit Load
					Cube	Weight		
664WP	8" Square Cake Pan (664)	32.0	7 7/8 x 7 7/8 x 1 5/16	w/ Plastic Dome (P664)	2.02	9.00	100	
69310TP	10" 3-Cmpt. Oblong Tray (69310)	--	10 x 9 1/4 x 1 3/8	Foil Lam. Board Cover (L69310)	4.06	30.00	250	
788TP	Carry-Out Oblong Tray (788)	36.0	8 1/2 x 6 x 1 3/4	Foil Lam. Board Cover (L788)	1.40	14.50	250	

### Aluminum Classic Carry-Out® Packaging

Product Number	Description	Capacity (fl. oz.)	Top Out	Dimensions (in inches)		Vert. Depth	Case Cube	Case Weight	Case Pack	Cases/ Unit Load
				Top In	Bottom					
6707WPSFG	16 oz. Oval Foil Base w/Dome Lid w/Fog-Gard™ Coating	Base: 16.0 Lid:	7 9/16 x 5 1/4	6 7/8 x 4 9/16	6 35/64 x 4 15/64	1 5/16	1.09	7.82	100	
6708WPZFG	Single Serve Black/Gold Foil Base w/Flat Lid w/Fog-Gard Coating	Base: 22.0 Lid:	8 3/16 x 6 3/16	7 1/2 x 5 1/2	7 3/16 x 5 3/16	1 1/4 27/64	1.37	8.02	100	
6708WPSFG	Single Serve Black/Gold Foil Base w/Dome w/Fog-Gard Coating	Base: 22.0 Dome:	8 3/16 x 6 3/16	7 1/2 x 5 1/2	7 3/16 x 5 3/16	1 1/4 1 3/16	1.37	8.12	100	
Y6710WPZFG	Small Black/Gold Foil Base w/Flat Lid w/Fog-Gard Coating	Base: 46.0 Lid:	9 3/4 x 7 3/4	9 x 7	8 9/16 x 6 9/16	1 3/4 7/16	1.12	6.53	50	50
Y6710WPSFG	Small Black/Gold Foil Base w/Dome w/Fog-Gard Coating	Base: 46.0 Dome:	9 3/4 x 7 3/4	9 x 7	8 9/16 x 6 9/16 1 3/16	1 3/4	1.12	6.53	50	50
6711WP	Large Blk/Gold Foil Base w/Dome	Base: 60.0 Dome:	11 1/4 x 8 7/8	10 7/16 x 8 1/16	10 x 7 5/8	1 3/4 1 7/32	1.45	10.23	50	

### Aluminum Rack 'N' Roast® Roasters

Product Number	Description	Capacity (fl. oz.)	Top Out	Dimensions (in inches)		Vert. Depth	Case Cube	Case Weight	Rim Style	Case Pack	Cases/ Unit Load
				Top In	Bottom						
6278XHY	Large Crown Oval Roaster	256.3	18 1/4 x 14	16 15/16 x 12 11/16	15 1/8 x 10 7/8	3 1/4	2.77	12.21	F.C.	50	18
6298XHY	Large Crown Rectangular Roaster	202.8	17 1/2 x 13 1/16	16 1/16 x 11 11/16	14 1/4 x 9 7/8	2 7/8	2.49	11.85	F.C.	50	18

### Nutrition Products

Product Number	Description	Capacity (fl. oz.)	Top Out	Dimensions (in inches)		Vert. Depth	Rim Style	Case Cube	Case Weight	Case Pack	Cases/ Unit Load
				Top In	Bottom						
Y7139TP	3-Cmpt. Sr. Citizen Hi-Divider Oblong Tray (7139) w/ Foil Laminated Board Cover (L739)	13.0/5.5/5.5	8 1/2 x 6 1/2	8 x 5 7/8	7 1/4 x 5 1/8	1 1/2	I.V.C.	1.28	14.12	200	45
Y7139TPP	3-Cmpt. Sr. Citizen Hi-Divider Oblong Tray (7139) w/ Ovenable Paper Cover (L739P)	13.0/5.5/5.5	8 1/2 x 6 1/2	8 x 5 7/8	7 1/4 x 5 1/8	1 1/2	I.V.C.	1.28	14.12	200	45
Y7239TP	3-Cmpt. Hi-Divider Hemmed Edge Oblong Tray (7239) w/ Foil Laminated Board Cover (L739)	13.0/5.5/5.5	8 1/2 x 6 1/2	8 x 5 7/8	7 1/4 x 5 1/8	1 1/2	H.E.	3.25	18.00	200	
7089TP	4-Cmpt. Sr. Citizen Oblong Tray (7089) w/ Foil Laminated Board Cover (L7089)	10.0/4.2/4.0/4.0	9 x 7	8 1/2 x 6 1/2	7 3/4 x 5 3/4	1 13/32	I.V.C.	2.40	20.00	250	

## School Feeding Containers / Compartmented Foil Trays

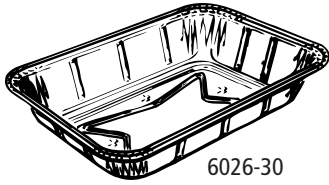

6026-30

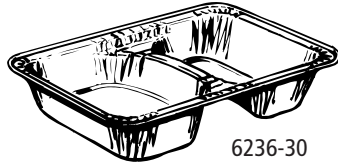

6236-30

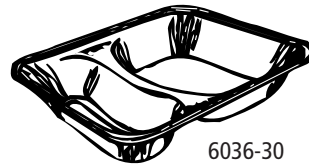

6036-30

## Hefty® Fast-Pak® Pre-Portioned Utility Bags

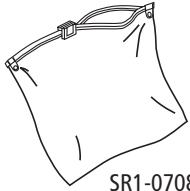

SR1-0708

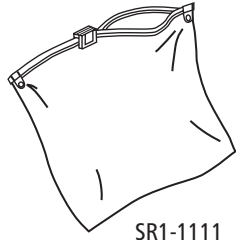

SR1-1111

## ClearView™ Micromax® Containers — Clear Lids/Domes, Black Bases



CN8-5100

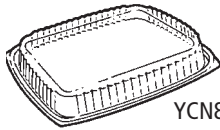

YCN8-5101D



CN8-5200

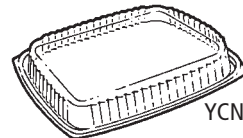

YCN8-5201D



CN8-5008



CN8-5012

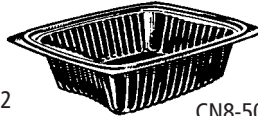

CN8-5016

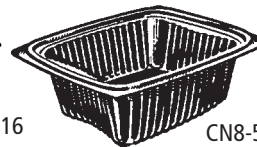

CN8-5024



CN8-5032



YCI8-5300

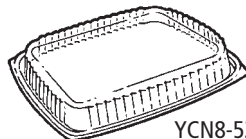

YCN8-5301D

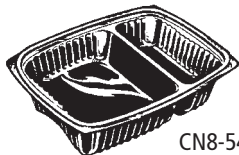

CN8-5420

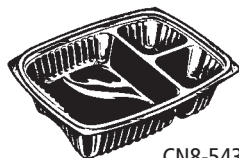

CN8-5430

### School Feeding Containers / Compartmented Foil Trays

Product Number	Description	Capacity (fl. oz.)	Top Out	Dimensions (in inches)		Vert. Depth	Case Cube	Case Weight	Case Pack
				Top In	Bottom				
6026-30	1 lb. Shallow Oblong Pan	14.0	6 1/2 x 5	6 x 4 1/2	5 x 3 1/2	1 17/64	2.94	19.57	1000
6036-30	2-Cmpt. Oblong Hamburger Pan	5.9/3.4	6 1/2 x 5	6 x 4 1/2	5 x 3 1/2	1 17/64	2.94	21.68	1000
6326-30	Deep Oblong Pan	17.7	6 1/2 x 5	6 1/32 x 4 17/32	5 11/32 x 3 27/32	1 7/16	2.94	23.22	1000
6236-30	2-Cmpt. Oblong Deep Hamburger Pan	8.0/3.8	6 1/2 x 5	6 x 4 1/2	5 5/16 x 3 13/16	1 33/64	2.94	24.70	1000
69107-30	2-Cmpt. Oblong Deep Hot Dog Pan	9.3/6.0	6 1/2 x 5	6 x 4 1/2	5 3/8 x 3 7/8	1 3/8	3.09	27.71	1000

### Hefty® Fast-Pak® Pre-Portioned Utility Bags

Product Number	Description	Dimensions (in inches)	Case Count	Cases Per Skid	Cube	Case
						Ship Wt. (lbs.)
SR1-0708	Quart-size utility bag	8" x 7"	750 (3 packs of 250)	40	3.62	10.80
SR1-1111	Gallon-size utility bag	10 1/2" x 11"	250	102	.5	5.77

### ClearView™ Micromax® Containers — Clear Lids/Domes, Black Bases

Product Number	Description	Capacity (fl. oz.)	Dimensions	Cube	Case	Packing Sleeve	Cases/ Unit Load
					Approx Wt.		
CN8-5008	8 oz. Black Tray (TFPP)	8 oz.	5 7/8 x 4 7/8 x 1 1/4	1.51	5.64	4/63	252
CN8-5012	12 oz. Black Tray (TFPP)	12 oz.	5 15/16 x 4 15/16 x 2 1/6	1.66	18.84	4/63	252
CN8-5016	16 oz. Black Tray (TFPP)	16 oz.	7 1/2 x 6 7/16 x 1 1/2	2.41	12.46	4/63	252
CN8-5024	24 oz. Black Tray (TFPP)	24 oz.	7 1/2 x 6 7/16 x 1 15/16	2.47	12.42	4/63	252
CN8-5032	32 oz. Black Tray (TFPP)	32 oz.	7 1/2 x 6 7/16 x 2 1/4	2.47	13.57	4/63	252
YCN8-5420	Black 2-Cmpt. Oblong Tray (TFPP)	9 oz.(S) - 20 oz.(L)	9 x 7 3/8 x 1 7/8	3.25	17.78	4/55	220
YCN8-5430	Black 3-Cmpt. Oblong Tray (TFPP)	4 oz.(S) - 20 oz.(L)	9 x 7 3/8 x 1 7/8	3.28	17.78	4/55	220
CN8-5100	Clear Snap-on Lid for 8 & 12 oz. Trays	--	5 29/32 x 4 29/32	0.99	3.50	4/63	252
YCN8-5101D	Clear Snap-on Dome Lid for 8 & 12 oz. Trays w/Fog Gard™ Coating	--	5 29/32 x 4 29/32 x 1	0.82	4.35	4/63	252 70
CN8-5200*	Clear Snap-on Lid for 16, 24 & 32 oz. Trays	--	7 1/2 x 6 1/2	1.41	6.48	4/63	252
YCN8-5201D	Clear Snap-on Dome Lid for 16, 24, & 32 oz. Trays w/Fog Gard Coating	--	7 1/2 x 6 1/2 x 1	1.25	7.12	4/63	252 45
YCI8-5300	Clear Snap-on Lid for 2 & 3 Cmpt. Trays	--	9 x 7 13/32	1.71	7.50	4/55	220 30
YCN8-5301D	Clear Snap-on Dome Lid for 2 & 3 Cmpt. Trays w/Fog Gard Coating	--	9 x 7 13/32 x 1	1.95	8.42	4/55	220 24

D = Dry Antifog Fog Gard™ (NEW), Z = Zip Seal™, Y = Perfect Cube

**ClearView™ Micromax® Oval Containers — Clear Lids, Black Bases**

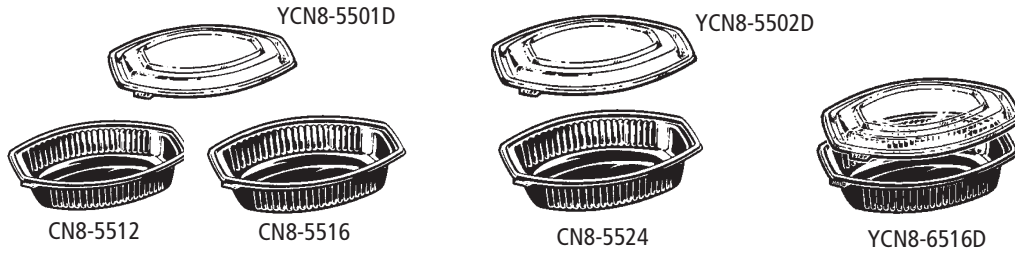

**ClearView™ Micromax® Rib Containers w/Fog Gard™ Coating**



**ClearView™ MealMaster® Roaster Containers w/Fog Gard™ Coating — Clear Lids/Domes, Black Bases**

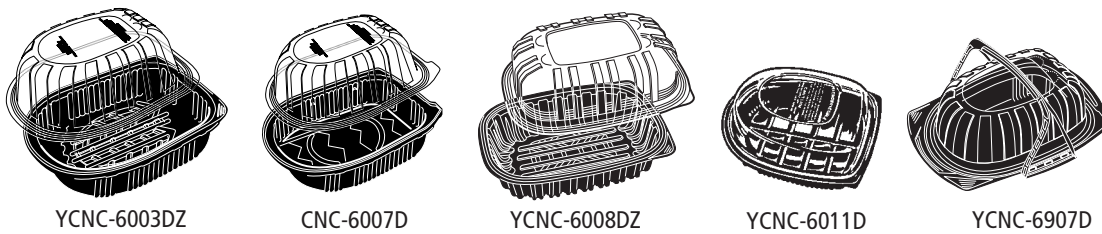

**ClearView™ MealMaster® Chicken Barn™ Containers w/Smart Tote™ Handles**

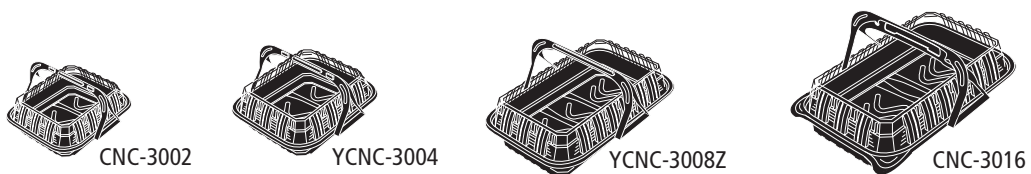

**ClearView™ MealMaster® HMR Containers w/Fog Gard Coating — Small**

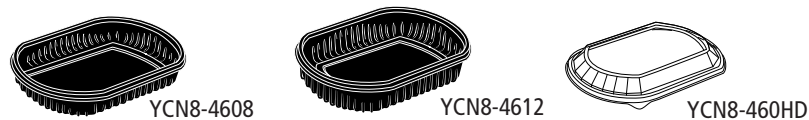

**ClearView™ MealMaster® HMR Containers w/Fog Gard Coating — Medium**

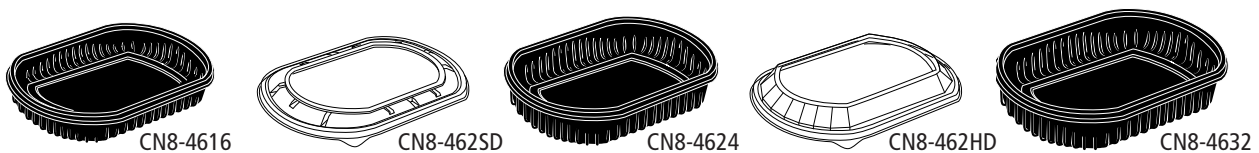

**ClearView™ Micromax® Oval Containers — Clear Lids, Black Bases**

Product Number	Description	Capacity (fl. oz.)	Dimension	Cube	Case Approx Wt.	Packing Sleeve	Case	Cases/ Unit Load
CN8-5512	12 oz. Black Oval Casserole (TFPP)	12 oz.	7 7/8 x 5 1/4 x 2 1/4	1.82	7.75	4/63	250	
CN8-5516	16 oz. Black Oval Casserole (TFPP)	16 oz.	7 7/8 x 5 1/4 x 2 1/2	1.82	7.75	4/63	250	
CN8-5524	24 oz. Black Oval Casserole (TFPP)	24 oz.	8 3/8 x 6 x 2 1/2	2.27	10.58	4/63	250	
YCN8-5501D	Clear Dome Snap-on Lid for 12 & 16 oz. Oval Casseroles w/Fog Gard Coating	--	7 7/8 x 5 1/4 x 1/4	1.73	6.64	4/63	252	27
YCN8-5502D	Clear Dome Snap-on Lid for 24 oz. Oval Casserole w/Fog Gard Coating	--	8 3/8 x 6 x 1/4	2.23	7.49	4/63	252	24
YCN8-6516D	16 oz. Black Oval Casserole (TFPP) and Lid w/Fog Gard Coating	16oz.	7 7/8 x 5 1/4 x 2 3/4	3.19	14.63	4/63 ea.	252 ea.	18

**ClearView™ Micromax® Rib Containers w/Fog Gard™ Coating**

Product Number	Description	Capacity (fl. oz.)	Dimensions (in inches)	Cube	Case Approx Wt.	Packing Sleeve	Case	Cases/ Unit Load
YCNC-6514D	Combo Pack - Full Slab Rib Container with Dome Lid	--	16 5/8 x 7 1/8 x 2 5/16	1.90	15.10	1/80	80	27
YCNC-6509D	Combo Pack - Half Slab Rib Container with Dome Lid	--	10 13/16 x 7 1/8 x 2 5/16	1.62	9.13	1/80	80	36

**ClearView™ MealMaster® Roaster Containers w/Fog Gard™ Coating — Clear Lids/Domes, Black Bases**

Product Number	Description	Capacity (fl. oz.)	Dimensions (in inches)	Cube	Case Approx Wt.	Packing Sleeve	Case	Cases/ Unit Load
YCNC-6003DZ	X-Large Roaster Base w/Dome Lid w/Fog Gard™ Coating - with ZipSeal™	50.0	10 3/4 x 8 1/2 x 4 1/4	2.26	14.03	1/95 ea.	95 ea.	24
CNC-6007D	Medium Roaster Base w/Dome Lid w/Fog Gard™ Coating	32.0	10 3/8 x 7 7/8 x 4	2.04	12.83	1/100 ea.	100 ea.	24
YCNC-6008DZ	Medium to Large Roaster Base w/Dome Lid w/Fog Gard™ Coating - with ZipSeal™	50.0	10 x 7.7 x 4 1/2	2.02	13.46	1/100 ea.	100 ea.	30
YCNC-6011D	Small Roaster Base w/Dome Lid w/Fog Gard™ Coating	24.3	9 5/8 x 7 x 3 1/2	1.58	8.62	1/80 ea.	80 ea.	24
YCNC-6907D	Handled Chicken Roaster Container w/Dome Lid w/Fog Gard™ Coating	32.0	11 1/4 x 8.6 x 4 1/4	2.95	20.62	1/120 ea.	120 ea.	18

**ClearView™ MealMaster® Chicken Barn™ Containers w/Smart Tote™ Handles**

Product Number	Description	Dimensions (in inches)	Case Cube	Case Weight	Sleeve	Case Pack	Cases/ Unit Load
CNC-3002	Small MealMaster® Chicken Barn™ Container w/Dome (2 pc.)		2.36	14.66	1/200 ea.	200 ea.	
YCNC-3004	Small MealMaster® Chicken Barn™ Container w/Dome (4 pc.)	9 1/2 x 8 x 3	2.15	11.75	1/100 ea.	100 ea.	24
YCNC-3008Z	Medium MealMaster® Chicken Barn™ Container w/Dome - with ZipSeal™ (8 pc.)	13 3/10 x 8 2/5 x 4	3.33	19.77	1/105 ea.	105 ea.	18
CNC-3016	Large Small MealMaster® Chicken Barn™ Container w/Dome (16 pc.)	14 x 10 1/2 x 4	2.56	14.77		50	

D = Dry Antifog Fog Gard™ (NEW), Z = Zip Seal™, Y = Perfect Cube

**ClearView™ MealMaster® HMR Containers w/Fog Gard Coating — Small**

Product Number	Description	Capacity (fl. oz.)	Dimensions (In Inches) Top Out	Cube	Case Approx Wt.	Packing Sleeve	Case	Cases/ Unit Load
YCN8-4608	Small Black Tray	8 oz.	6 1/8 x 4 7/8 x 1 1/8	1.35	12.01	4/58	232	
YCN8-4612	Small Black Tray	12 oz.	6 1/8 x 4 7/8 x 1 5/8	1.35	9.72	4/58	232	
YCN8-460HD	Small Dome Lid w/Fog Gard Coating	--	6 1/8 x 4 7/8 x 1	1.06	4.74	4/58	232	24

**ClearView™ MealMaster® HMR Containers w/Fog Gard Coating — Medium**

Product Number	Description	Capacity (fl. oz.)	Dimensions (In Inches) Top Out	Cube	Case Approx Wt.	Packing Sleeve	Case	Cases/ Unit Load
CN8-4616	Medium Black Tray	16 oz.	8 1/8 x 6 1/2 x 1	2.39	11.70	4/63	252	
CN8-4624	Medium Black Tray	24 oz.	8 1/8 x 6 1/2 x 1 1/2	2.39	12.89	4/63	252	
CN8-4632	Medium Black Tray	32 oz.	8 1/8 x 6 1/2 x 2	2.39	12.89	4/63	252	
CN8-462SD	Medium Flat Lid w/Fog Gard Coating	--	8 1/8 x 6 1/2 x 3/8	2.39	10.00	4/63	252	
CN8-462HD	Medium Dome Lid w/Fog Gard Coating	--	8 1/8 x 6 1/2 x 1	2.39	8.00	4/63	252	

**ClearView™ MealMaster™ HMR Containers w/Fog Gard Coating — Large**

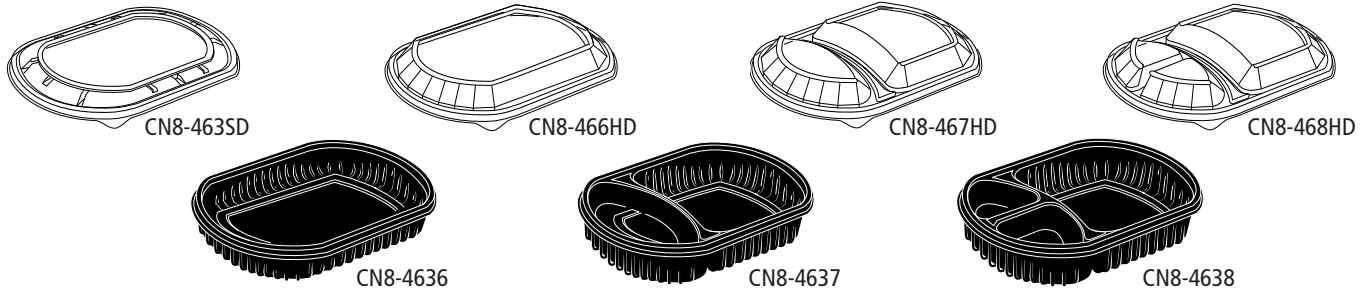

**Pressware® Classic Stoneware™ Dual-Ovenable Paperboard Trays – White w/Brown Specks**

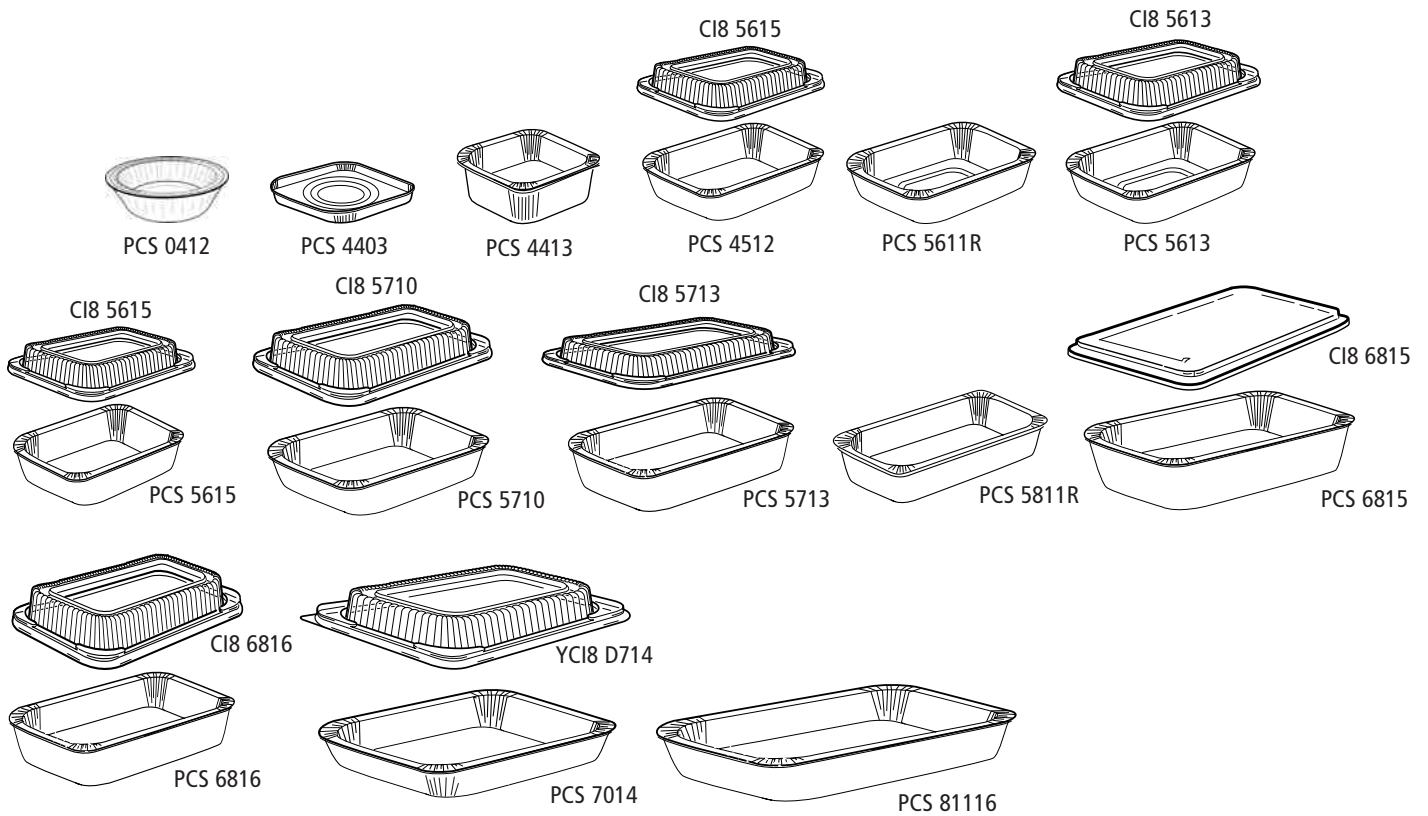

**Pressware® Dual-Ovenable Paperboard Deli Trays & Domes**

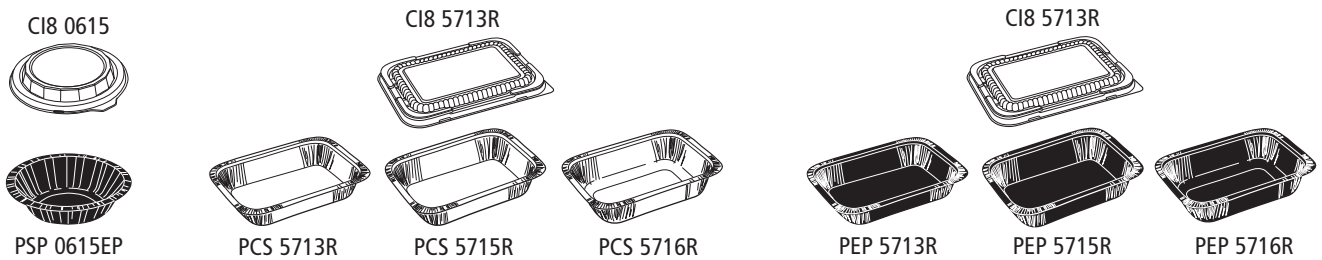

**ClearView™ MealMaster™ HMR Containers w/Fog Gard Coating — Large**

Product Number	Description	Capacity (fl. oz.)	Dimensions (In Inches) Top Out	Cube	Case Approx Wt.	Packing Sleeve	Case
CN8-4636	Large Black 1-Compartment Tray	36 oz.	9 3/8 x 8 x 1 1/2	3.22	16.50	4/63	252
CN8-4637	Large Black 2-Compartment Tray	21 oz., 10 oz.	9 3/8 x 8 x 1 1/2	3.22	16.50	4/63	252
CN8-4638	Large Black 3-Compartment Tray	21 oz., 4.5 oz., 4.5 oz.	9 3/8 x 8 x 1 1/2	3.22	16.50	4/63	252
CN8-4635D	Large Flat Lid w/Fog Gard Coating	--	9 3/8 x 8 x 3/8	3.22	10.85	4/63	252
CN8-466HD	Large 1-Compartment Dome Lid w/Fog Gard Coating	--	9 3/8 x 8 x 1 1/4	3.22	11.04	4/63	252
CN8-467HD	Large 2-Compartment Dome Lid w/Fog Gard Coating	--	9 3/8 x 8 x 1 1/4	3.22	11.04	4/63	252
CN8-468HD	Large 3-Compartment Dome Lid w/Fog Gard Coating	--	9 3/8 x 8 x 1 1/4	3.22	11.04	4/63	252

**Pressware® Classic Stoneware™ Dual-Ovenable Paperboard Trays – White w/Brown Specks**

Product Number	Description	Capacity (fl. oz.)	Top Out	Dimensions (in inches) Top In	Bottom	Vert. Depth	Cube	Case Approx. Wt.	Case Pack
PCS 0412	Round Tray	5.70	4 3/16	3 11/16	2 13/16	1 1/4	1.32	17.85	1000
PCS 4403	Square Tray (uncoated)	3.50	4 3/16 x 4 5/16	4 3/16 x 4 5/16	4 1/32 x 4 1/32	3/8	2.45	29.98	3000
PCS 4412	Square Tray	5.80	4 3/16 x 4 3/16	3 11/16 x 3 11/16	2 11/16 x 2 11/16	1 1/4	1.91	29.94	1500
PCS 4413	Square Tray	9.50	4 5/8 x 4 5/8	4 1/8 x 4 1/8	3 3/32 x 3 3/32	1 3/8	1.63	24.90	1000
PCS 4512	Oblong Tray	13.0	4 7/8 x 5 15/16	4 3/8 x 5 7/16	3 11/32 x 4 9/16	1 1/4	2.17	28.21	1000
PCS 5611R	Oblong Tray (rounded corners)	13.8	4 29/32 x 6 17/32	4 13/32 x 6 1/32	3 25/32 x 5 9/32	1 1/8	3.05	30.40	1000
PCS 5613	Oblong Tray	14.5	4 31/32 x 6 9/16	4 15/32 x 6 1/166	3 7/16 x 4 15/16	1 3/8	3.05	35.47	1000
CI8 5613	Oblong Dome Lid for 5613	--	5 7/32 x 6 13/16	--	--	7/8	4.82	13.00	1000
PCS 5613RR1	Oblong Tray (rounded corners)	14.5	4 27/32 x 6 17/32	4 11/32 x 6 1/32	3 1/2 x 5	1 3/8	1.47	17.04	500
CI8 5613R	Obong Dome Lid for 5613R	--	5 3/32 x 6 25/32	--	--	7/8	5.41	15.00	1000
PCS 5615	Oblong Tray	16.8	4 29/32 x 6 3/32	4 13/32 x 5 19/32	3 3/16 x 4 5/16	1 11/16	1.63	18.21	500
CI8 5615	Oblong Dome Lid for 4512 & 5615	--	5 5/32 x 6 11/32	--	--	1/2	3.36	13.00	1000
PCS 5710	Oblong Tray	15.4	5 1/16 x 7 13/16	4 9/16 x 7 5/16	4 1/16 x 6 11/16	1	2.18	17.22	500
CI8 5710	High Dome Lid for 5710 & 5713	--	5 7/16 x 8 1/16	--	--	1 1/8	2.92	11.00	500
PCS 5713	Oblong Tray	20.8	5 1/16 x 7 25/32	4 9/16 x 7 9/32	3 5/8 x 6 5/16	1 3/8	1.30	11.17	250
CI8 5713	Low Dome Lid for 5710 & 5713	--	5 7/16 x 8 1/32	--	--	1/2	1.18	6.00	250
PCS 5811R	Oblong Tray (rounded corners)	20.5	5 29/32 x 8 9/32	5 13/32 x 7 25/32	4 25/32 x 7	1 1/8	2.41	24.99	500
PCS 6815	Oblong Tray	36.7	6 19/32 x 8 3/4	6 3/32 x 8 1/4	5 1/8 x 7 1/16	1 5/8	1.74	16.75	250
CI8 6815	Oblong Dome Lid for 6815	--	6 31/32 x 9 1/8	--	--	1/4	2.22	12.00	250
PCS 6816	Oblong Tray	32.0	6 x 7 7/8	5 1/2 x 7 3/8	4 1/4 x 6 1/8	1 3/4	2.36	27.01	500
CI8 6816	Obong Dome Lid for 6816	--	6 1/4 x 8 1/8	--	--	3/8	2.91	12.00	500
PCS 7014	Oblong Tray	45.0	7 15/32 x 9 31/32	6 31/32 x 9 15/32	6 x 8 5/16	1 1/2	2.05	21.08	250
YCI8 D714	Obong Dome Lid for 7014	--	7 23/32 x 10 7/32	--	--	3/4	2.55	11.00	280
PCS 81116*	Oblong Tray	64.3	8 9/16 x 11 31/32	8 1/16 x 11 15/32	6 3/8 x 9 5/8	1 3/4	3.93	29.08	250

Do Not Place Dome Lids In Conventional or Microwave Ovens. Do Not Use PRESSWARE® Containers In Toaster Ovens.

\*Item is an MTO product. Please contact your Pactiv sales representative for order minimum and lead time.

**Pressware® Dual-Ovenable Paperboard Deli Trays & Domes**

Product Number	Description	Capacity (fl. oz.)	Dimensions (In Inches)	Cube	Case Approx Wt.	Case Pack
PSP 0615EP	Ebony Premier Black Round Deli Bowl	16.5	6 11/32 x 1 5/8	1.60	19.80	500
PCS 5713R	Classic Stoneware Shallow Oblong Deli Tray	21.3	5 7/16 x 7 7/16 x 1 3/8	2.30	22.10	500
PCS 5715R	Classic Stoneware Oblong Deli Tray	23.0	5 3/8 x 7 3/8 x 1 3/4	2.53	22.71	500
PCS 5716R	Classic Stoneware Deep Oblong Deli Tray	25.0	5 7/16 x 7 7/16 x 1 3/4	1.50	13.70	250
PEP 5713R	Ebony Premier Black Shallow Oblong Deli Tray	21.3	5 7/16 x 7 7/16 x 1 3/8	2.30	22.70	500
PEP 5715R	Ebony Premier Black Oblong Deli Tray	23.0	5 3/8 x 7 3/8 x 1 3/4	2.53	22.71	500
PEP 5716R	Ebony Premier Black Deep Oblong Deli Tray	25.0	5 7/16 x 7 7/16 x 1 3/4	1.50	14.10	250
CI8 0615	Clear Dome Lid for 0615 Round Bowl	--	--	3.10	13.40	500
CI8 5713R	Clear Dome Lid for 5713R/5716R Oblong Trays	--	--	2.20	10.00	500

## Pressware® Ebony Premier® Dual-Ovenable Paperboard Trays

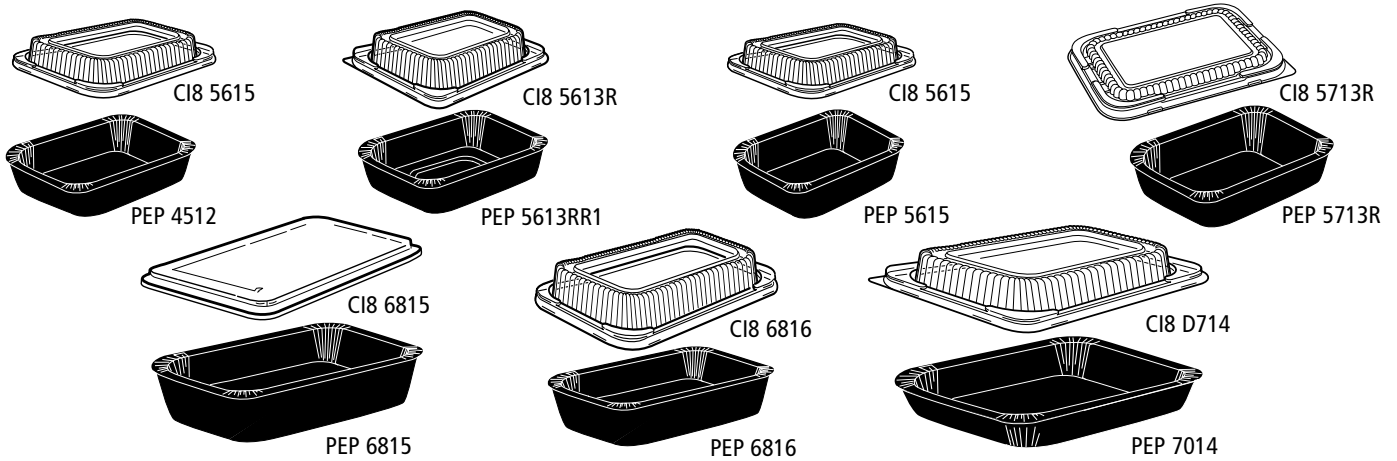

## Clear OPS Dome Lids for *Pressware* Trays

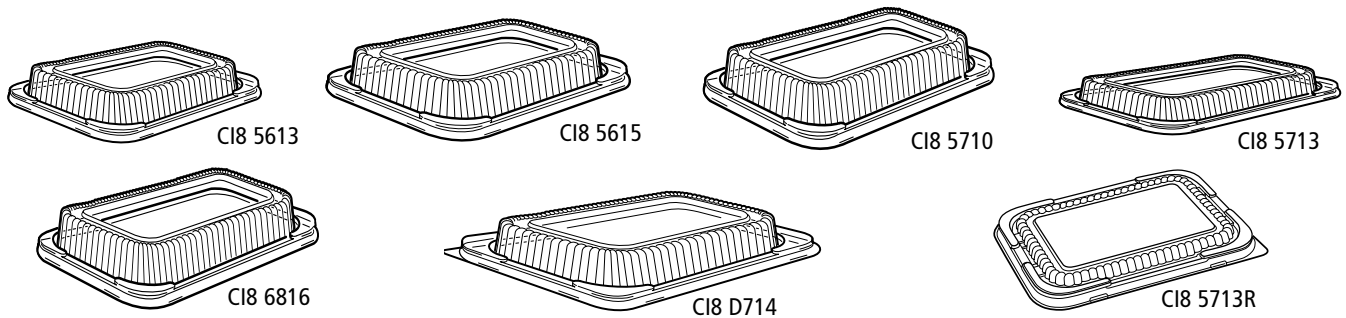

## APET Square Salad Containers

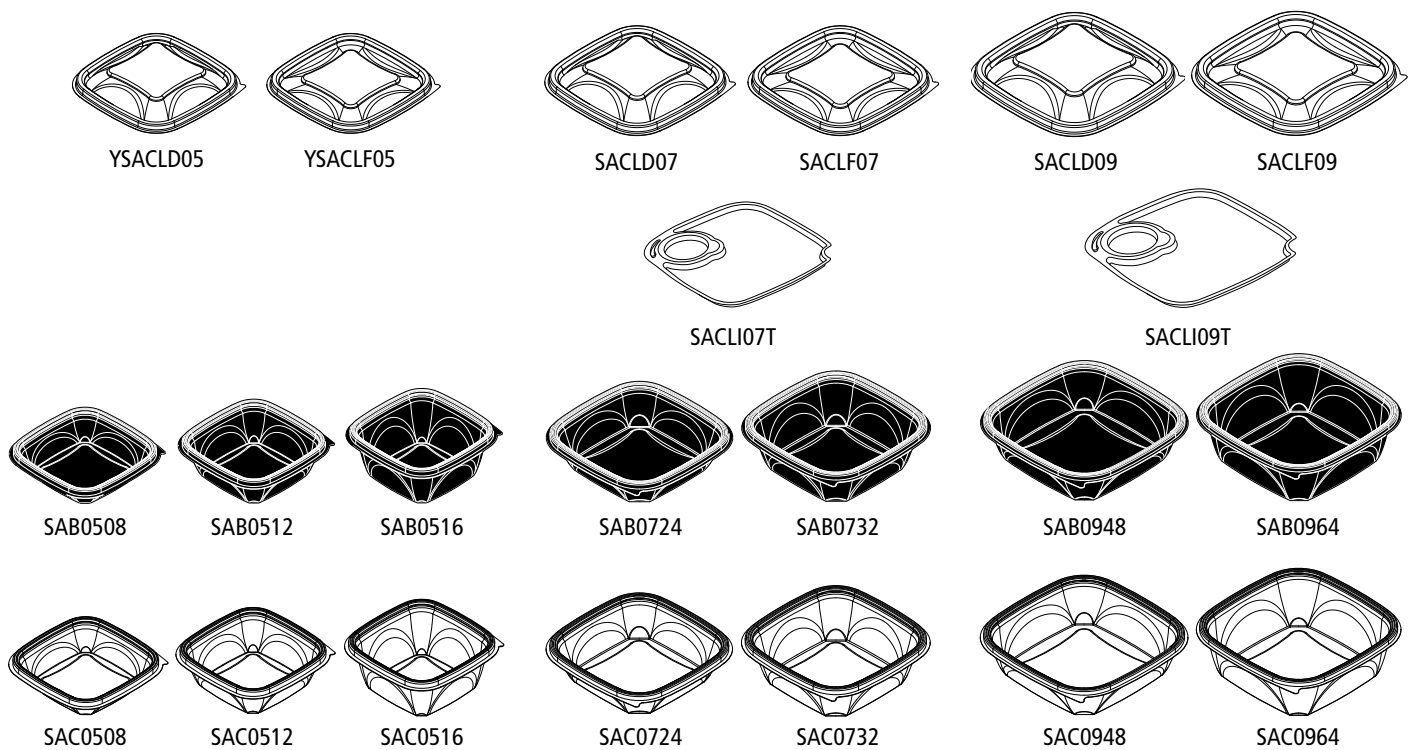



**Pressware® Ebony Premier® Dual-Ovenable Paperboard Trays – Black**

Product Number	Description	Capacity (fl. oz.)	Dimensions (in inches)			Vert. Depth	Cube	Case Approx. Wt.	Case Pack
			Top Out	Top In	Bottom				
PEP 4512	Oblong Tray	13.0	4 7/8 x 5 29/32	4 3/8 x 5 7/16	3 17/32 x 4 9/16	1 1/4	2.17	29.17	1000
PEP 5613RR1	Oblong Tray (rounded corners)	14.5	4 29/32 x 6 17/32	4 11/32 x 6 1/32	3 1/2 x 5	1 3/8	1.47	17.51	500
C18 5613R	Obong Dome Lid for 5613R	–	5 3/32 x 6 25/32	–	–	7/8	5.41	15.00	1000
PEP 5615	Oblong Tray	16.8	4 15/16 x 6 5/32	4 13/32 x 5 19/32	3 3/16 x 4 5/16	1 11/16	1.63	21.49	500
C18 5615	Oblong Dome Lid for 4512, 5615 Conts.	–	5 5/32 x 6 11/32	–	–	1/2	3.36	13.00	1000
PEP 5713R	Oblong Tray (rounded corners)	21.3	5 15/32 x 7 15/32	4 31/32 x 6 15/16	4 3/32 x 6	1 3/8	2.53	25.70	500
C18 5713R	Obong Dome Lid for 5713R	–	5 11/16 x 7 11/16	–	–	1/4	2.23	10.00	500
PEP 6815	Oblong Tray	36.7	6 9/16 x 8 3/4	6 3/32 x 8 1/4	5 1/8 x 7 1/16	1 5/8	1.74	19.47	250
C18 6815	Obong Dome Lid for 6815	–	6 31/32 x 9 1/8	–	–	1/4	2.22	12.00	250
PEP 6816	Oblong Tray	32.0	6 1/32 x 7 15/16	5 1/2 x 7 3/8	4 1/4 x 6 1/8	1 3/4	2.36	31.52	500
C18 6816	Obong Dome Lid for 6816	–	6 1/4 x 8 1/8	–	–	3/8	2.91	12.00	500
PEP 7014	Oblong Tray	45.0	7 15/32 x 9 31/32	6 31/32 x 9 15/32	6 x 8 5/16	1 1/2	2.05	21.51	250
YC18 D714	Obong Dome Lid for 7014	–	7 23/32 x 10 7/32	–	–	3/4	2.55	11.00	280

**Clear OPS Dome Lids for Pressware Trays**

Product Number	Description	Capacity (fl. oz.)	Dimensions (in inches)			Vert. Depth	Cube	Case Approx. Wt.	Case Pack
			Top Out	Top In	Bottom				
C18 5613	Oblong Dome Lid for 5613	–	5 7/32 x 6 13/16	–	–	7/8	4.82	13.0	1000
C18 5613R	Obong Dome Lid for 5613R	–	5 3/32 x 6 25/32	–	–	7/8	5.41	15.0	1000
C18 5615	Oblong Dome Lid for 5615	–	5 5/32 x 6 11/32	–	–	1/2	3.36	13.0	1000
C18 5710	High Dome Lid for 5710	–	5 5/16 x 8 1/16	–	–	1 1/8	2.92	11.0	500
C18 5713	Low Dome Lid for 5713	–	5 5/16 x 8 1/32	–	–	1/2	1.18	6.00	250
C18 5713R	Obong Dome Lid for 5713R, 5716R	–	5 11/16 x 7 11/16	–	–	1/4	2.23	10.0	500
C18 6815	Oblong Dome Lid for 6815	–	6 31/32 x 9 1/8	–	–	1/4	2.22	12.0	250
C18 6816	Oblong Dome Lid for 6816	–	6 1/4 x 8 1/8	–	–	3/8	2.91	12.0	500
YC18 D714	Oblong Dome Lid for 7014	–	7 23/32 x 10 7/32	–	–	3/4	2.55	11.0	280

Do Not Place Dome Lids In Conventional or Microwave Ovens

**APET Square Salad Containers**

Product Number	Description	Dimension (in inches)	Bowl Depth (in inches)	Case Cube	Approx. Wt.	Packing	
						Sleeve	Case
SAB0508	8 oz Black Square Bowl Base	5 x 5	1.0	3.08	14.93	8/63	504
SAB0512	12 oz Black Square Bowl Base	5 x 5	1.45	3.08	16.04	8/63	504
SAB0516	16 oz Black Square Bowl Base	5 x 5	2.0	3.08	22.71	8/63	504
SAC0508	8 oz Clear Square Bowl Base	5 x 5	1.0	3.08	14.93	8/63	504
SAC0512	12 oz Clear Square Bowl Base	5 x 5	1.45	3.08	16.04	8/63	504
SAC0516	16 oz Clear Square Bowl Base	5 x 5	2.0	3.08	22.71	8/63	504
SAB0724	24 oz Black Square Bowl Base	7.375 x 7.375	1.52	3.24	18.41	4/75	300
SAB0732	32 oz Black Square Bowl Base	7.375 x 7.375	2.0	3.24	19.07	4/75	300
SAC0724	24 oz Clear Square Bowl Base	7.375 x 7.375	1.52	3.24	18.41	4/75	300
SAC0732	32 oz Clear Square Bowl Base	7.375 x 7.375	2.0	3.24	19.07	4/75	300
SAB0948	48 oz Black Square Bowl Base	9 x 9	2.0	2.54	15.43	2/75	150
SAB0964	64 oz Black Square Bowl Base	9 x 9	2.6	2.54	17.74	2/75	150
SAC0948	48 oz Clear Square Bowl Base	9 x 9	2.0	2.54	15.43	2/75	150
SAC0964	64 oz Clear Square Bowl Base	9 x 9	2.6	2.54	17.74	2/75	150
YSACLD05	8-12-16 oz Clear Dome Lid	5 x 5	.68	2.29	13.22	8/63	504
YSACLF05	8-12-16 oz Clear Flat Lid	5 x 5	.26	2.29	13.22	8/63	504
SACLD07	24-32 oz Clear Dome Lid	7.375 x 7.375	.83	2.39	13.97	4/75	300
SACLF07	24-32 oz Clear Flat Lid	7.375 x 7.375	.26	2.39	12.64	4/75	300
SACLD09	48-64 oz Clear Dome Lid	9 x 9	.84	1.80	10.66	2/75	150
SACLF09	48-64 oz Clear Flat Lid	9 x 9	.49	1.80	9.67	2/75	150
SACLI07T	7.375" Insert for Square Salad	7.375 x 7.375	.26	0.83	8.57	2/150	300
SACLI09T	9" Insert for Square Salad	9 x 9	.26	0.67	6.21	2/75	150

## Newspring VERSAtainer® Microwaveable Containers

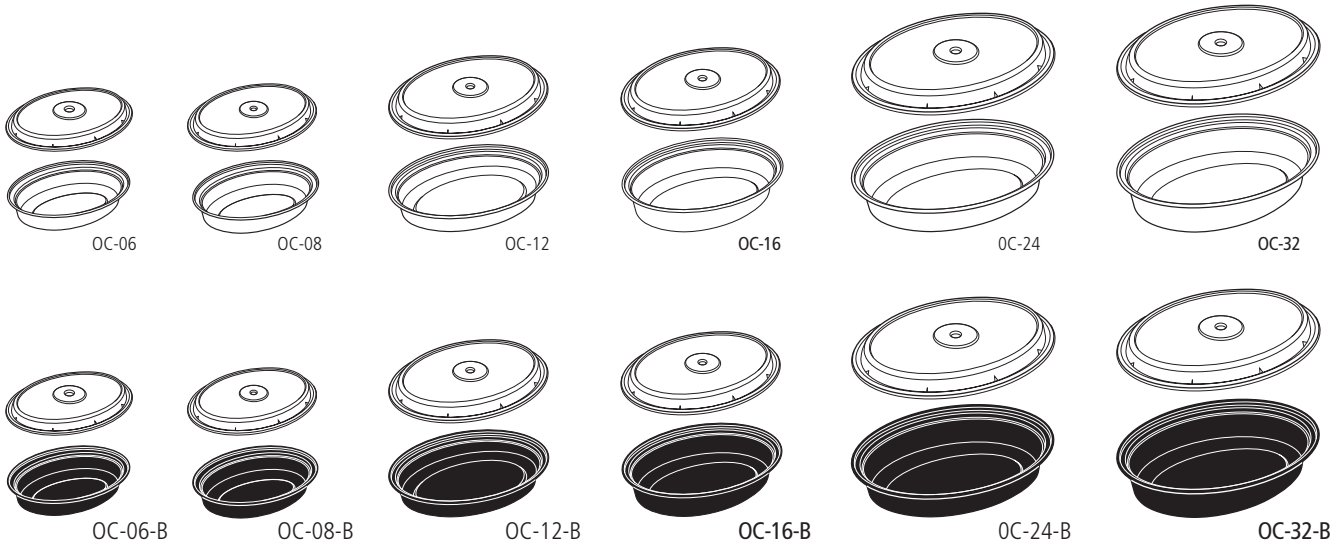

## Newspring VERSAtainer® Microwaveable Containers

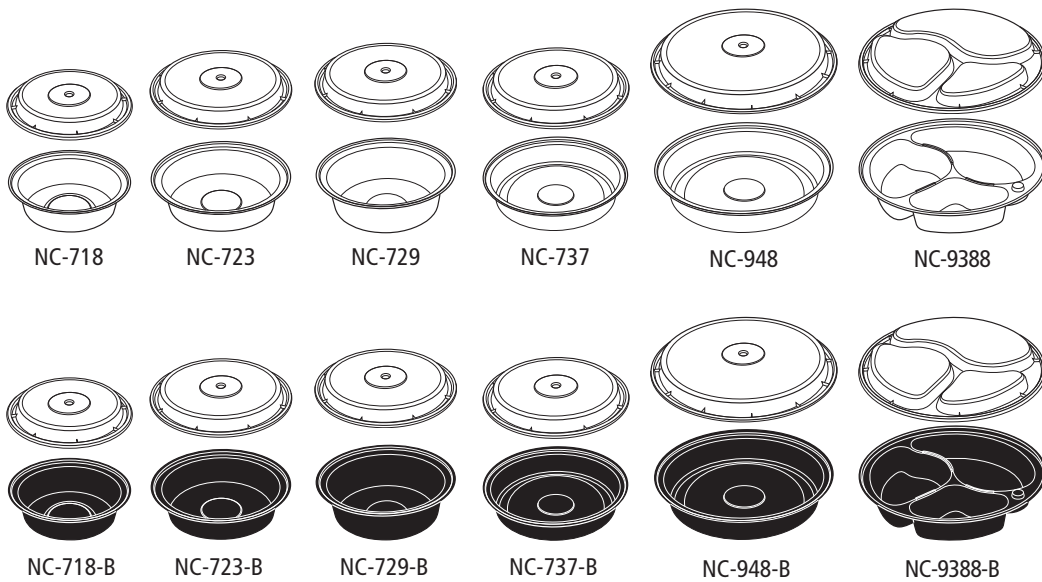

## Newspring VERSAtainer® Microwaveable Containers - Square

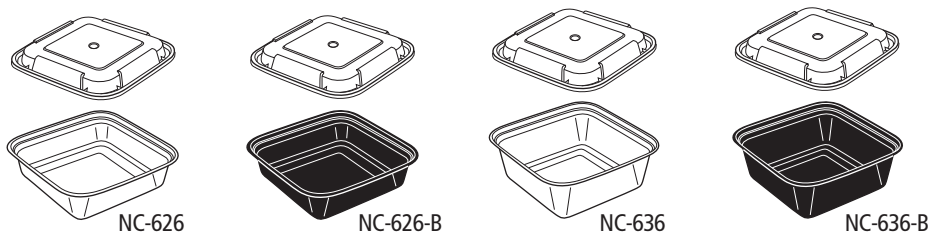

## Newspring VERSAtainer® Microwaveable Containers - Oval

Product #	Description	Dimensions	Case Pack	Case Cube	Case Weight (lbs.)	Pallet Count
OC-06	6 oz. white base w/ clear lid	5.7" x 4.0" x 1.1"	150 ea.	1.06	7.27	72
OC-06-B	6 oz. black base w/ clear lid	5.7" x 4.0" x 1.1"	150 ea.	1.06	7.27	72
OC-08	8 oz. white base w/ clear lid	5.7" x 4.0" x 1.45"	150 ea.	1.08	7.56	72
OC-08-B	8 oz. black base w/ clear lid	5.7" x 4.0" x 1.45"	150 ea.	1.08	7.56	72
OC-12	12 oz. white base w/ clear lid	6.8" x 4.8" x 1.45"	150 ea.	1.37	10.23	54
OC-12-B	12 oz. black base w/ clear lid	6.8" x 4.8" x 1.45"	150 ea.	1.37	10.23	54
OC-16	16 oz. white base w/ clear lid	6.8" x 4.8" x 1.9"	150 ea.	1.46	10.73	54
OC-16-B	16 oz. black base w/ clear lid	6.8" x 4.8" x 1.9"	150 ea.	1.46	10.73	54
OC-24	24 oz. white base w/ clear lid	9.1" x 6.7" x 1.45"	150 ea.	2.57	18.35	24
OC-24-B	24 oz. black base w/ clear lid	9.1" x 6.7" x 1.45"	150 ea.	2.57	18.35	24
OC-32	32 oz. white base w/ clear lid	9.1" x 6.7" x 1.9"	150 ea.	2.63	17.91	24
OC-32-B	32 oz. black base w/ clear lid	9.1" x 6.7" x 1.9"	150 ea.	2.63	17.91	24

## Newspring VERSAtainer® Microwaveable Containers - Round

Product #	Description	Dimensions	Case Pack	Case Cube	Case Weight (lbs.)	Pallet Count
NC-718	16 oz. white base w/ clear lid	6"	150 ea.	1.75	12.81	42
NC-718-B	16 oz. black base w/ clear lid	6"	150 ea.	1.75	12.81	42
NC-723	24 oz. white base w/ clear lid	7"	150 ea.	1.94	16.30	40
NC-723-B	24 oz. black base w/ clear lid	7"	150 ea.	1.94	16.30	40
NC-729	32 oz. white base w/ clear lid	7"	150 ea.	1.94	17.16	40
NC-729-B	32 oz. black base w/ clear lid	7"	150 ea.	1.94	17.16	40
NC-737	35 oz. white base w/ clear lid	8"	150 ea.	2.84	22.95	24
NC-737-B	35 oz. black base w/ clear lid	8"	150 ea.	2.84	22.95	24
NC-948	48 oz. white base w/ clear lid	9"	150 ea.	3.25	26.42	18
NC-948-B	48 oz. black base w/ clear lid	9"	150 ea.	3.25	26.42	18
<b>Three Compartments (7 oz/12 oz/20 oz)</b>						
NC-9388	39 oz. white base w/ clear lid	9"	150 ea.	3.35	31.86	24
NC-9388-B	39 oz. black base w/ clear lid	9"	150 ea.	3.35	31.86	24
<b>Vented Containers</b>						
NC-948-BV	48 oz. black base w/ vented clear lid	9"	150 ea.	3.72	26.42	16

\* All products listed above are shipped in 150 count containers/lid combination packs. All products listed above are also available in a 300 count bulk pack by special order only.

## Newspring VERSAtainer® Microwaveable Containers - Square

Product #	Description	Dimensions	Case Pack	Case Cube	Case Weight (lbs.)	Pallet Count
NC-626	26 oz. white base w/ clear lid	6.75" x 6.75" x 2	150 ea.	2.13	17.29	30
NC-626-B	26 oz. black base w/ clear lid	6.75" x 6.75" x 2	150 ea.	2.13	17.29	30
NC-636	36 oz. white base w/ clear lid	6.75" x 6.75" x 2.6	150 ea.	2.23	19.19	30
NC-636-B	36 oz. black base w/ clear lid	6.75" x 6.75" x 2.6	150 ea.	2.23	19.19	30

\* All products listed above are shipped in 150 count containers/lid combination packs. All products listed above are also available in a 300 count bulk pack by special order only.

**Newspring VERSAtainer® Microwaveable Containers - Rectangular**

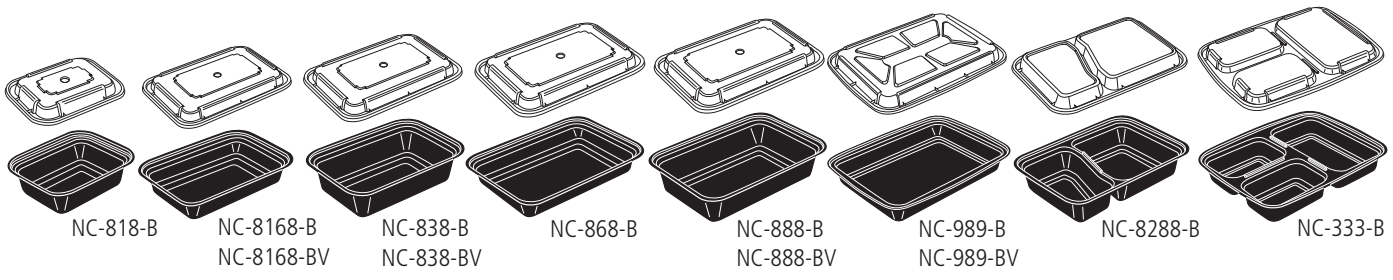
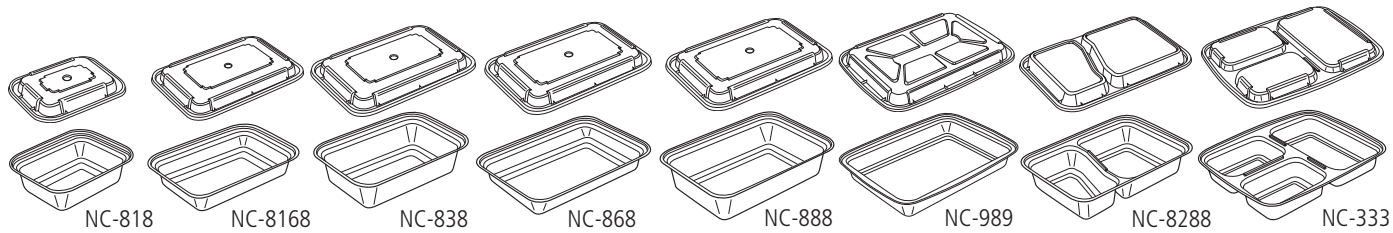

**EarthChoice® TFPP Hinged Containers**

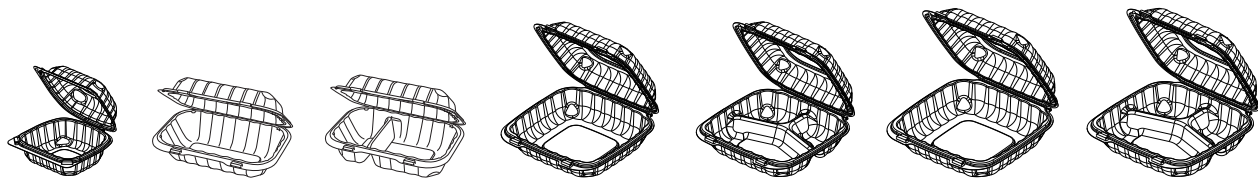

## Newspring VERSAtainer® Microwaveable Containers - Rectangular

Product #	Description	Dimensions	Case Pack	Case Cube	Case Weight (lbs.)	Pallet Count
NC-818	12 oz. white base w/ clear lid	4.5" x 5.5" x 1.75"	150 ea.	1.10	9.57	54
NC-818-B	12 oz. black base w/ clear lid	4.5" x 5.5" x 1.75"	150 ea.	1.10	9.57	54
NC-8168	16 oz. white base w/ clear lid	5" x 7.25" x 1.5"	150 ea.	1.35	14.15	60
NC-8168-B	16 oz. black base w/ clear lid	5" x 7.25" x 1.5"	150 ea.	1.35	14.15	60
NC-838	24 oz. white base w/ clear lid	5" x 7.25" x 2"	150 ea.	1.39	13.68	60
NC-838-B	24 oz. black base w/ clear lid	5" x 7.25" x 2"	150 ea.	1.39	13.68	60
NC-868	28 oz. white base w/ clear lid	6" x 8.5" x 1.5"	150 ea.	1.89	18.59	40
NC-868-B	28 oz. black base w/ clear lid	6" x 8.5" x 1.5"	150 ea.	1.89	18.59	40
NC-888	38 oz. white base w/ clear lid	6" x 8.5" x 2"	150 ea.	1.96	19.04	40
NC-888-B	38 oz. black base w/ clear lid	6" x 8.5" x 2"	150 ea.	1.96	19.04	40
NC-989	58 oz. white base w/ clear lid	8.5" x 11.5" x 1.5"	150 ea.	2.82	33.89	20
NC-989-B	58 oz. black base w/ clear lid	8.5" x 11.5" x 1.5"	150 ea.	2.82	33.89	20
<b>Two Compartments (12 oz/18 oz)</b>						
NC-8288	30 oz. white base w/ clear lid	6" x 8.5" x 1.875"	150 ea.	1.98	18.50	40
NC-8288-B	30 oz. black base w/ clear lid	6" x 8.5" x 1.875"	150 ea.	1.98	18.50	40
<b>Three Compartments (8 oz/8 oz/16 oz)</b>						
NC-333	32 oz. white base w/ clear lid	7.5" x 9.875" x 1.75"	150 ea.	2.35	27.97	32
NC-333-B	32 oz. black base w/ clear lid	7.5" x 9.875" x 1.75"	150 ea.	2.35	27.97	32
<b>Vented Containers</b>						
NC-8168-BV	16 oz. black base w/ vented clear lid	5" x 7.25" x 1.5"	150 ea.	1.58	14.15	48
NC-838-BV	24 oz. black base w/ vented clear lid	5" x 7.25" x 2"	150 ea.	1.77	13.68	42
NC-888-BV	38 oz. black base w/ vented clear lid	6" x 8.5" x 2"	150 ea.	1.96	19.04	40
NC-989-BV	58 oz. black base w/ vented clear lid	8.5" x 11.5" x 1.5"	150 ea.	2.82	33.89	20

\* All products listed above are shipped in 150 count containers/clear lid combination packs. All products listed above are also available in a 300 count bulk pack by special order only.

## EarthChoice® TFPF Hinged Containers

Item Number	Description	Capacity (fl. Oz.)	Dimensions (in inches)	Case Cube	Case Weight	Case Sleeve	Case Pack	Cases/ Unit Load
YCN8-0600-0000	1-Cmpt. SmartLock® Sandwich Hinged Container	16	5.75" x 5.95" x 3.10"	3.05	23.53	4/100	400	16
YCN8-0961-0000	1-Cmpt. SmartLock® Hinged Hoagie Container	24	9" x 6" x 3"	3.33	25.01	2/135	270	16
YCN8-0962-0000	2-Cmpt. SmartLock® Hinged Hoagie Container	6/16	9" x 6" x 3"	3.33	25.01	2/135	270	16
YCN8-0801-0000	1-Cmpt. SmartLock® Medium Hinged Container	32	8.35" x 8.35" x 3.1"	2.78	22.59	2/100	200	18
YCN8-0803-0000	3-Cmpt. SmartLock® Medium Hinged Container	4/4/14	8.35" x 8.35" x 3.1"	2.78	22.59	2/100	200	18
YCN8-0901-0000	1-Cmpt. SmartLock® Large Hinged Container	42	9.33" x 8.88" x 3.1"	1.72	16.21	1/120	120	30
YCN8-0903-0000	3-Cmpt. SmartLock® Large Hinged Container	6/6/18	9.33" x 8.88" x 3.1"	1.72	16.21	1/120	120	30



# Processor Packaging



Product Number	Description	Page
1064	64 OZ. APET CLEAR ROUND TUB	G13
1064DP3CLRL	64 OZ. APET CLEAR 3-CELL PLATTER W/ DIP CUP - LEAK RESISTANT LID	G19
1064DP4CLRL	64 OZ. APET CLEAR 4-CELL PLATTER W/ DIP CUP - LEAK RESISTANT LID	G19
1064DP4VL	64 OZ. APET CLEAR 3-CELL PLATTER W/ DIP CUP - VENTED LID	G19
1068	68 OZ. APET CLEAR ROUND TUB	G13
1096	96 OZ. APET CLEAR ROUND TUB	G13
10962C	96 OZ. APET CLEAR ROUND TUB W/ 2 COMPARTMENTS	G15
1096AB	96 OZ. APET CLEAR ROUND COOKIE CELL TUB	G15
1096DB	96 OZ. APET CLEAR ROUND TUB W/ DOME BOTTOM	G13
10128	128 OZ. APET CLEAR ROUND TUB	G13
10145	145 OZ. APET CLEAR ROUND TUB	G13
10156	156 OZ. APET CLEAR ROUND TUB	G13
101603C	160 OZ. APET CLEAR ROUND TUB W/ 3 COMPARTMENTS	G13
1019090	190 OZ. APET CLEAR ROUND TUB	G13
10324C200	32 OZ. APET CLEAR ROUND TUB W/ 4 COMPARTMENTS	G13
10643C	64 OZ. APET CLEAR ROUND TUB W/ 3 COMPARTMENTS	G13
10644C	64 OZ. APET CLEAR ROUND TUB W/ 4 COMPARTMENTS	G13
10646C	64 OZ. APET CLEAR ROUND TUB W/ 6 COMPARTMENTS	G13
10646CJ	64 OZ. APET CLEAR ROUND TUB W/ 6 COMPARTMENTS W/ JUICE TRAP	G13
10684C	68 OZ. APET CLEAR ROUND TUB W/ 4 COMPARTMENTS	G13
10963C	96 OZ. APET CLEAR ROUND TUB W/ 3 COMPARTMENTS	G13
10FL	10" APET CLEAR FLAT LID	G15
10FL200	10" APET CLEAR FLAT LID	G13
10FLC200	10" APET CLEAR FLAT LID W/ CENTER SNAP	G13
10JL200	10" APET CLEAR JEWEL LID	G13,G15
10JLC200	10" APET CLEAR JEWEL LID W/ CENTER SNAP	G13
11X14124DM4C	124 OZ. APET CLEAR 4-CELL PLATTER W/ MEDIUM DIP CUP	G19
11X1451LRLC	124 OZ. APET CLEAR 4-CELL PLATTER W/ MEDIUM DIP CUP	G19
1240TW	WHITE TOMATO TRAY W/RESERVOIR BOTTOM	G9
1240TWE6	WHITE TOMATO TRAY W/RESERVOIR BOTTOM AND LAMINATE	G9
13220DP4C	13" APET CLEAR 4-CELL PLATTER W/8 OZ. DIP CUP - LEAK RESISTANT	G19
1325DD4C	13" APET CLEAR 4-CELL PLATTER W/12 OZ. DIP CUP - LEAK RESISTANT	G19
1325DD4CJ	13" APET CLEAR 4-CELL PLATTER W/8 OZ. DIP CUP, JUICE TRAP - LEAK RESISTANT	G19
1325DP4C	13" APET CLEAR 4-CELL PLATTER W/8 OZ. DIP CUP - LEAK RESISTANT	G19
1325DP4CJ	13" APET 4-CELL PLATTER W/12 OZ. DIP CUP, JUICE TRAP - LEAK RESISTANT	G19
1330DP4CJ	13" APET 4-CELL PLATTER W/8 OZ. DIP CUP, JUICE TRAP - LEAK RESISTANT	G19
135CLID	13" APET PLATTER LID - LEAK RESISTANT	G19
13VL	13" APET PLATTER VENTED LID	G19
4H101JDPLTE	10 OZ. HINGED TAMPER RESISTANT CUP W/ JUICE TRAP, DIP CUP	G17
4H101JILTE	10 OZ. HINGED TAMPER RESISTANT CUP W/ JUICE TRAP, FLAT INSIDE LID	G17
58P1FPX15	WHITE FAMILY PACK TRAY W/LAMINATE	G9
58P1FPX25	WHITE FAMILY PACK TRAY W/LAMINATE	G9
58P1FPX35	WHITE FAMILY PACK TRAY W/LAMINATE	G9
58P9X37T	BLACK TOMATO TRAY	G9
5X714PTE	14 OZ. APET RECTANGULAR FLAT INSIDE LID	G17
5X71LTE	APET RECTANGULAR SMOOTH TAMPER RESISTANT BOWL W/ JUICE TRAP	G17
6S172CJ	17 OZ. APET SQUARE CLEAR 2-CELL PLATTER W/ JUICE TRAP	G19
6S172DP3CJ	17 OZ. APET SQUARE CLEAR 3-CELL PLATTER W/ DIP CUP & JUICE TRAP	G19
718	18 OZ. APET CLEAR ROUND TUB	G11
724	24 OZ. APET CLEAR ROUND TUB	G11
727STEP	27 OZ. APET CLEAR ROUND TUB	G11
728DB	28 OZ. APET CLEAR ROUND TUB W/DOME BOTTOM	G11
732	32 OZ. APET CLEAR ROUND TUB	G11
7322C	32 OZ. APET CLEAR ROUND TUB W/ 2 COMPARTMENTS	G13
7324C	32 OZ. APET CLEAR ROUND TUB W/ 4 COMPARTMENTS	G13
734DB	34 OZ. APET CLEAR ROUND TUB W/ DOME BOTTOM	G11
738	38 OZ. APET CLEAR ROUND TUB	G11
739DB	39 OZ. APET CLEAR ROUND TUB W/ HIGH DOME BOTTOM	G11
740DB	40 OZ. APET CLEAR ROUND TUB W/ DOME BOTTOM	G11
744	44 OZ. APET CLEAR ROUND TUB	G11
748	48 OZ. APET CLEAR ROUND TUB	G11
756	56 OZ. APET CLEAR ROUND TUB	G11
7564LRLTE	64 OZ. APET CLEAR TAMPER RESISTANT TUB W/ LEAK RESISTANT LID	G17
755128	128 OZ. APET CLEAR SQUARE SHELF SAVERS® CONTAINER	G17
755175	175 OZ. APET CLEAR SQUARE SHELF SAVERS® CONTAINER	G17
755FL	7.5" APET CLEAR SQUARE SHELF SAVERS® FLAT LID	G17
755FLTRED	7.5" APET CLEAR SQUARE SHELF SAVERS® FLAT TRANSLUCENT RED LID	G17
760DB	60 OZ. APET CLEAR ROUND TUB W/ DOME BOTTOM	G11
764	64 OZ. APET CLEAR ROUND TUB	G11
770DB	70 OZ. APET CLEAR ROUND TUB W/ DOME BOTTOM	G11
772	72 OZ. APET CLEAR ROUND TUB	G11
772RS	66 OZ. APET CLEAR ROUND TUB W/ SQUARE BOTTOM	G11
780	80 OZ. APET CLEAR ROUND TUB	G11
788	88 OZ. APET CLEAR ROUND TUB	G11
7AL300	7" APET AUTO LID	G11, G13
7CL	7" APET CROWN LID	G11, G13
7FL	7" APET FLAT LID	G11, G13
7JL	7" APET JEWEL LID	G11, G13
7028DB320	28 OZ. APET OCTAGONAL CLEAR TUB W/DOME BOTTOM	G13
7032	32 OZ. APET OCTAGONAL CLEAR TUB	G13
7044DB	32 OZ. APET OCTAGONAL CLEAR TUB W/DOME BOTTOM	G13
7048	48 OZ. APET OCTAGONAL CLEAR TUB	G13
7060DB	60 OZ. APET OCTAGONAL CLEAR TUB W/DOME BOTTOM	G13
7064	64 OZ. APET OCTAGONAL CLEAR TUB	G13
70L	7" APET OCTAGONAL LID	G11, G13
830R	60 OZ. APET CLEAR ROUND TUB	G13
89200TB	BLACK TOMATO TRAY W/RESERVOIR BOTTOM	G9
89200TBE6	BLACK TOMATO TRAY W/RESERVOIR BOTTOM AND LAMINATE	G9
8925TW	WHITE TOMATO TRAY W/RESERVOIR BOTTOM	G9
8925TB6	BLACK TOMATO TRAY W/RESERVOIR BOTTOM AND LAMINATE	G9
8925TBR	BLACK TOMATO TRAY W/RESERVOIR BOTTOM	G9

Product Number	Description	Page
8FL	8" APET CLEAR FLAT LID	G13
8554LR	54 OZ. APET SQUARE CLEAR BOWL - LEAK RESISTANT	G19
8575LR	75 OZ. APET SQUARE CLEAR BOWL - LEAK RESISTANT	G19
85IL	8" APET SQUARE FLAT INSIDE LID - LEAK RESISTANT	G19
8X11702CP	70 OZ. APET RECTANGULAR CLEAR BOWL W/ 2 CELLS	G19
8X1172P	72 OZ. APET RECTANGULAR CLEAR BOWL	G19
8X11802PPL	80 OZ. APET RECTANGULAR CLEAR BOWL W/ DOME LID - LEAK RESISTANT	G19
8X11PL	APET DOME LID - LEAK RESISTANT	G19
92519	1 PINT BERRY BASKET	G9
92520	1/2 PINT BERRY BASKET	G9
92521	1 PINT SPROUT CONTAINER	G9
A9744	6 OZ. CLEAR BERRY CLAMSHELL	G7
A9756	4.4 OZ. CLEAR BERRY CLAMSHELL	G7
A9759	1 PINT CLEAR CLAMSHELL	G7
A9761	1/2 PINT HINGED BASKET	G7
A9762	1 LB. CLEARSTRAWBERRY CLAMSHELL	G7
A9769	4 LB. CLEAR TABLE GRAPE CLAMSHELL	G7
A9777	18 OZ. CLEAR BLUEBERRY CLAMSHELL	G7
A9777LO	18 OZ. CLEAR BLUEBERRY LOW PROFILE CLAMSHELL	G7
A9778	4 LB. CLEAR MODULAR CLAMSHELL	G7
A9779	2 LB. CLEAR BLUEBERRY MODULAR CLAMSHELL	G7
A9784	2 LB. CLEAR BERRY CLAMSHELL	G7
A9785	2 LB. CLEAR MODULAR BERRY CLAMSHELL	G7
A9786	2.75 LB. CLEAR MODULAR BLUEBERRY CLAMSHELL	G7
A9786T	2.75 LB. CLEAR MODULAR BLUEBERRY CLAMSHELL	G7
A9788	4 LB. CLEAR MODULAR STRAWBERRY CLAMSHELL	G7
A9792	1 LB. CLEAR MODULAR BERRY CLAMSHELL - FL	G7
A9793	1 LB. CLEAR MODULAR BERRY CLAMSHELL - CA	G7
C18 0412	CLEAR DOME FOR PRESSWARE® 0412 BOWL	G5
C18-0615	CLEAR DOME LID FOR 0615EP ROUND BOWL	G5
C18 5613	CLEAR DOME FOR PRESSWARE 5613 CONTAINER	G5, G7
C18 5613R	CLEAR DOME FOR PRESSWARE 5613R CONTAINER	G5, G7
C18 5615	CLEAR DOME FOR PRESSWARE 5615 CONTAINER	G5, G7
C18 5710	CLEAR HIGH DOME FOR PRESSWARE 5710, 5713 CONTAINERS	G5, G7
C18 5713	CLEAR LOW DOME FOR PRESSWARE 5710, 5713 CONTAINERS	G5, G7
C18 5713R	CLEAR DOME FOR PRESSWARE 5713R, 5716R CONTAINERS	G5, G7
C18 6815	CLEAR DOME FOR PRESSWARE 6815 CONTAINER	G5, G7
C18 6816	CLEAR DOME FOR PRESSWARE 6816 CONTAINER	G5, G7
FL500Y	NEWSPRING DELITAINER® OVERCAP LID FOR 8-32 CONTAINERS	G21
L5008Y	8 OZ. NEWSPRING DELITAINER® CLEAR DELI CONTAINER BULK PACK	G21
L5012Y	12 OZ. NEWSPRING DELITAINER® CLEAR DELI CONTAINER BULK PACK	G21
L5020Y	20 OZ. NEWSPRING DELITAINER® CLEAR DELI CONTAINER BULK PACK	G21
L5024Y	24 OZ. NEWSPRING DELITAINER® CLEAR DELI CONTAINER BULK PACK	G21
L6064	64 OZ. NEWSPRING DELITAINER® CLEAR DELI TUB BULK PACK	G21
L-7080-N	80 OZ. NEWSPRING DELITAINER® NATURAL DELI TUB	G21
L-7128-N	128 OZ. NEWSPRING DELITAINER® NATURAL DELI TUB	G21
L-7168	16 OZ. NEWSPRING DELITAINER® CLEAR SQUAT CONTAINER & LID	G21
L-8128-N	128 OZ. NEWSPRING DELITAINER® SQUAT NATURAL DELI TUB	G21
L-8160-N	160 OZ. NEWSPRING DELITAINER® NATURAL DELI TUB	G21
L-8328	32 OZ. NEWSPRING DELITAINER® CLEAR SQUAT CONTAINER & LID	G21
M33-6153	1/2 BBL GREEN HALF PINT CONTAINER	G9
M33-6184	2 BB GREEN DEEP FLUTE QUART CONTAINER	G9
MAPI175	APET CLEAR SALAD/SANDWICH TRAY - 1 3/4" DEEP	G11
MAPI225	APET CLEAR SALAD/SANDWICH TRAY - 2 1/4" DEEP	G11
MAPI13	APET CLEAR SALAD/SANDWICH TRAY - 3" DEEP	G11
MAPIDL	APET CLEAR SALAD/SANDWICH TRAY FLAT LID	G11
MAPIFL	APET CLEAR SALAD/SANDWICH TRAY DOME LID	G11
MLB1L0650	50 OL2 6.5" WEB 3000 LINEAR FOOT ROLL LIDDING FILM	G3
MLB1L0725	50 OL2 7.25" WEB 3000 LINEAR FOOT ROLL LIDDING FILM	G3
MLB1L0850	50 OL2 8.5" WEB 3000 LINEAR FOOT ROLL LIDDING FILM	G3
MLB1L0950	50 OL2 9.5" WEB 3000 LINEAR FOOT ROLL LIDDING FILM	G3
MLC3C0615	100 OLAF-0615 CLEAR ADVANTAGE™ LIDDING FILM	G3
MLC3C0813	100 OLAF-0813H/0816H CLEAR ADVANTAGE LIDDING FILM	G3
MLC3C5613	100 OLAF-5613/5613R CLEAR ADVANTAGE LIDDING FILM	G3
MLC3C5615	100 OLAF-5615/4512 CLEAR ADVANTAGE LIDDING FILM	G3
MLC3C5713R	100 OLAF-5713R CLEAR ADVANTAGE LIDDING FILM	G3
MLC3C6816	100 OLAF-6816 CLEAR ADVANTAGE LIDDING FILM	G3
MLC4C5615	150 OLAF-5615/4512 CLEAR ADVANTAGE LIDDING FILM	G3
MLC4C5713R	150 OLAF-5713R CLEAR ADVANTAGE LIDDING FILM	G3
MLC4C6815	150 OLAF-6815 CLEAR ADVANTAGE LIDDING FILM	G3
MLC4C6816	150 OLAF-6816 CLEAR ADVANTAGE LIDDING FILM	G3
MLC4C7014	150 OLAF-7014 CLEAR ADVANTAGE LIDDING FILM	G3
MLK1L0525	50 RL42 5.25" WEB 3000 LINEAR FOOT ROLL LIDDING FILM	G3
MLK1L0850	50 RL42 8.5" WEB 3000 LINEAR FOOT ROLL LIDDING FILM	G3
MLK1L0950	50 RL42 9.5" WEB 3000 LINEAR FOOT ROLL LIDDING FILM	G3
MLK1L1025	50 RL42 10.25" WEB 3000 LINEAR FOOT ROLL LIDDING FILM	G3
NL-640L	NEWSPRING DELITAINER LID FOR 48 & 64 OZ TUBS	G21
NL-740	NEWSPRING DELITAINER LID FOR 80, 96, 112, 128 OZ TUBS	G21
NL-810N	NEWSPRING DELITAINER LID FOR 112, 128, 144, 160 OZ TUBS	G21
P92501	PINT DOME	G9
P92501NV	PINT DOME - NON-VENTED	G9
P92503	SHALLOW 1 PINT DOME	G9
P92503NV	SHALLOW 1 PINT DOME NONVENTED	G9
P9739	PLASTIC DOME LID FOR 1/2 BBL	G9
PCS 0412	PRESSWARE® CLASSIC STONWARE® ROUND TRAY	G5
PCS 4403	PRESSWARE CLASSIC STONWARE SQUARE TRAY (UNCOATED)	G5
PCS 4412	PRESSWARE CLASSIC STONWARE SQUARE TRAY	G5
PCS 4413	PRESSWARE CLASSIC STONWARE SQUARE TRAY	G5
PCS 4512	PRESSWARE CLASSIC STONWARE OBLONG TRAY	G5
PCS 5611R	PRESSWARE CLASSIC STONWARE OBLONG TRAY (ROUNDED CORNERS)	G5
PCS 5613	PRESSWARE CLASSIC STONWARE OBLONG TRAY	G5



Product Number	Description	Page
PCS 5613RR1	PRESSWARE CLASSIC STONEWARE OBLONG TRAY (ROUNDED CORNERS).....	G5
PCS 5615	PRESSWARE CLASSIC STONEWARE OBLONG TRAY .....	G5
PCS 5710	PRESSWARE CLASSIC STONEWARE OBLONG TRAY .....	G5
PCS 5713	PRESSWARE CLASSIC STONEWARE OBLONG TRAY .....	G5
PCS 5713R	PRESSWARE CLASSIC STONEWARE SHALLOW OBLONG TRAY (ROUNDED CORNERS) .....	G5
PCS 5715R	PRESSWARE CLASSIC STONEWARE OBLONG TRAY (ROUNDED CORNERS).....	G5
PCS 5716R	PRESSWARE CLASSIC STONEWARE DEEP OBLONG TRAY (ROUNDED CORNERS) ....	G5
PCS 5811R	PRESSWARE CLASSIC STONEWARE OBLONG TRAY (ROUNDED CORNERS).....	G5
PCS 6815	PRESSWARE CLASSIC STONEWARE OBLONG TRAY .....	G5
PCS 6816	PRESSWARE CLASSIC STONEWARE OBLONG TRAY .....	G5
PCS 7014	PRESSWARE CLASSIC STONEWARE OBLONG TRAY .....	G5
PEP 0813H	PRESSWARE EBONY PREMIER SHALLOW OVAL DELI TRAY .....	G5
PEP 0816H	PRESSWARE EBONY PREMIER DEEP OVAL DELI TRAY .....	G5
PEP 4512	PRESSWARE EBONY PREMIER OBLONG TRAY .....	G5
PEP 5613RR1	PRESSWARE EBONY PREMIER OBLONG TRAY (ROUNDED CORNERS).....	G5
PEP 5615	PRESSWARE EBONY PREMIER OBLONG TRAY .....	G5
PEP 5713R	PRESSWARE EBONY PREMIER SHALLOW OBLONG TRAY (ROUNDED CORNERS)....	G5
PEP 5715R	PRESSWARE EBONY PREMIER OBLONG TRAY (ROUNDED CORNERS).....	G5
PEP 5716R	PRESSWARE EBONY PREMIER DEEP OBLONG TRAY (ROUNDED CORNERS)...	G5
PEP 6815	PRESSWARE EBONY PREMIER OBLONG TRAY .....	G5
PEP 6816	PRESSWARE EBONY PREMIER OBLONG TRAY .....	G5
PEP 7014	PRESSWARE EBONY PREMIER OBLONG TRAY .....	G5
PP01	10.25" APET 3 CMPT PRODUCE PLATTER W/DIP CUP .....	G15
PP05	10.25" APET 4 CMPT PRODUCE PLATTER W/DIP CUP .....	G15
PP09	13" APET 3 CMPT PRODUCE PLATTER W/DIP CUP .....	G15
PP0531	10.25" APET 4 CMPT PRODUCE PLATTER W/DIP CUP .....	G15
PP17	13" APET 4 CMPT PRODUCE PLATTER W/DIP CUP - 1 9/16" DEEP .....	G15
PP2133	13" APET4 CMPT PRODUCE PLATTER W/DIP CUP & LID .....	G15
PP25	13" APET 4 CMPT PRODUCE PLATTER W/DIP CUP - 2 1/4" DEEP .....	G15
PP2533	13" APET 4 CMPT PRODUCE PLATTER W/DIP CUP .....	G15
PP29	13" APET 4 CMPT PRODUCE PLATTER W/DIP CUP - 3" DEEP .....	G15
PP31	10.25" APET PRODUCE PLATTER LID .....	G15
PP33	13" APET PRODUCE PLATTER LID .....	G15
PP43	10.25" APET 4 CMPT PRODUCE PLATTER W/DIP CUP - JUICE CATCHER....	G15
PSP 0615EP	PRESSWARE EBONY PREMIER ROUND DELI BOWL .....	G5
SD5016Y	16 OZ NEWSRING DELITAINER® CLEAR DELI CONTAINER BULK PACK.....	G21
SD5032Y	32 OZ NEWSRING DELITAINER® CLEAR DELI CONTAINER BULK PACK.....	G21
SI12025DC	APET DEEP DRAW CLEAR SQUARE DENESTABLE LID - 7 1/2" SQUARE .....	G17
SLL2016CL	APET DEEP DRAW CLEAR SQUARE LID - 7 1/2" SQUARE .....	G17
SLS2400PC	APET CLEAR PLAIN DEEP DRAW SQUARE LID .....	G15
SLS500CL	APET CLEAR DEEP DRAW SQUARE LID - WAY .....	G15
STL1130	130 OZ. APET DEEP DRAW SQUARE TUB - 7 1/2" SQUARE .....	G17
STL1142	142 OZ. APET DEEP DRAW SQUARE TUB - 7 1/2" SQUARE .....	G17
STL1160	160 OZ. APET DEEP DRAW SQUARE TUB - 7 1/2" SQUARE .....	G17
STL1175	175 OZ. APET DEEP DRAW SQUARE TUB - 7 1/2" SQUARE .....	G17
STS1016	16 OZ. APET DEEP DRAW SQUARE TUB - 6 3/4" SQUARE .....	G15
STS1032	32 OZ. APET DEEP DRAW SQUARE TUB - 6 3/4" SQUARE .....	G15
STS1080	80 OZ. APET DEEP DRAW SQUARE TUB - 6 3/4" SQUARE .....	G15
STS1134	134 OZ. APET DEEP DRAW SQUARE TUB - 6 3/4" SQUARE .....	G15
STS24	24 OZ. APET DEEP DRAW SQUARE TUB - 6 3/4" SQUARE .....	G15
TE08	8 OZ. NEWSRING TAMPER EVIDENT CONTAINER .....	G21
TE12	12 OZ. NEWSRING TAMPER EVIDENT CONTAINER .....	G21
TE16	16 OZ. NEWSRING TAMPER EVIDENT CONTAINER .....	G21
TE32	32 OZ. NEWSRING TAMPER EVIDENT CONTAINER .....	G21
TE48	48 OZ. NEWSRING TAMPER EVIDENT CONTAINER .....	G21
TEL160	NEWSRING TAMPER EVIDENT 8,12,16 OZ LID .....	G21
TEL320	NEWSRING TAMPER EVIDENT 32 OZ LID .....	G21
TEL480	NEWSRING TAMPER EVIDENT 48 OZ LID .....	G21
TL500Y	NEWSRING DELITAINER® OVERCAP LID FOR 8-32 CONTAINERS.....	G21
TRLID	APET ROUND DEEP DRAW TUB .....	G15
TRL1102	102 OZ. APET ROUND DEEP DRAW LID .....	G15
TRL1128	128 OZ. APET ROUND DEEP DRAW TUB .....	G15
TRL1160	160 OZ. APET ROUND DEEP DRAW TUB .....	G15
WDC16000	16 OZ. APET ROUND DELI CONTAINER .....	G11
WDC16L832K	16 OZ. APET ROUND DELI CONTAINER W/FLAT LID .....	G11
WDC28	24 OZ. APET ROUND DELI CONTAINER .....	G11
WDC32	24 OZ. APET ROUND DELI CONTAINER .....	G11
WDL83200D	APET DOME LID FOR ROUND DELI CONTAINERS .....	G11
WDL83200F	APET FLAT LID FOR ROUND DELI CONTAINERS .....	G11
WFC10646C	64 OZ. APET FANFARE 6 CMPT ROUND TUB - 9.75" DIA .....	G13
YA9770	2 LB. CLEAR TABLE GRAPE CLAMSHELL.....	G7
YA9771	1 LB. CLEAR MINI TOMATO CLAMSHELL .....	G7
YA9772	2 LB. CLEAR TABLE GRAPE CLAMSHELL.....	G7
YC18 D714	CLEAR DOME FOR PRESSWARE 7014 CONTAINER.....	G5, G7
YL2508	8 OZ NEWSRING DELITAINER® CLEAR DELI CONTAINER & LID .....	G21
YL2508-B	8 OZ NEWSRING DELITAINER® BLACK DELI CONTAINER & LID .....	G21
YL2512	12 OZ NEWSRING DELITAINER® CLEAR DELI CONTAINER & LID .....	G21
YL2512-B	12 OZ NEWSRING DELITAINER® BLACK DELI CONTAINER & LID .....	G21
YL2520	20 OZ NEWSRING DELITAINER® CLEAR DELI CONTAINER & LID .....	G21
YL2524	24 OZ NEWSRING DELITAINER® CLEAR DELI CONTAINER & LID .....	G21
YNL500	NEWSRING DELITAINER® RECESSED LID FOR 8-32 CONTAINERS .....	G21
YM33-6126	1 BBS GREEN PINT CONTAINER .....	G9
YPP2933	13" APET 4 CMPT PRODUCE PLATTER W/DIP CUP * LID .....	G15
YSD2516	16 OZ NEWSRING DELITAINER® CLEAR DELI CONTAINER BULK PACK.....	G21
YSD2532	32 OZ NEWSRING DELITAINER® CLEAR DELI CONTAINER & LID .....	G21
YSD2532B	32 OZ NEWSRING DELITAINER® BLACK DELI CONTAINER & LID .....	G21
YWDC12000	12 OZ. APET ROUND DELI CONTAINER .....	G11
YWDC24	24 OZ. APET ROUND DELI CONTAINER .....	G11
YWDC32L832K	32 OZ. APET ROUND DELI CONTAINER W/FLAT LID .....	G11
YWDC8000	8 OZ. APET ROUND DELI CONTAINER .....	G11

## Clear Advantage™ Lidding Film – Unprinted, Die Cut, Perforated Tear Sheets on 3” Core Roll

### APPLICATIONS

Foodservice	Tray lidding for in-store prepared foods: on-site/take-out consumption.
Commissary	Off-site prepared food item tray lidding.
Packer/Processor	Retail/Institutional frozen food tray lidding without folding carton.

### Features

### Benefits

Ovenable Film	
Conventional Oven	Can be used in conventional oven up to 400°F for up to 60 minutes.
Microwave Oven	All commercial or residential oven ratings up to 1000 watts.
Freezer Ready	Can be used in quick-freeze commercial freezers down to -40°F.
Pealable Seal	
Dupont® Mylar® Film	
100 OLAFT	No need to puncture or separate from tray before cooking. Film is easily stripped away after cooking.
150 OLAFT	Extra thickness for puncture resistance and large tray application.
Merchandising Appeal	Tamper evident, clear lidding film “window” for optimum food visibility. Optional custom printed graphics capability (Microwave use only).
Profile Cut	Custom die-cut to contour tray top-out dimension.
Packaging Convenience	Individual perforated tear sheets on 8” diameter roll. Each roll is boxed for sanitation and protection in shipping.
Machine Application	Table-top PBS8 Lidding Machine with custom tray carriers.
Economical	Less expensive when compared to OPS or windowed board lid options.
Leak Resistant	Prevents spillage of most liquids for take-out applications.

## 3000 Linear Foot Roll Lidding Film – 3000 Linear Feet of Film on 3” Core Roll

### APPLICATIONS

Foodservice	Take-out package lidding.
Commissary	Freezer ready, bulk prepared food tray lidding.
Packer/Processor	Retail/Institutional frozen food tray lidding with folding carton.

### Features

### Benefits

Ovenable Film	
Conventional Oven	Can be used in conventional oven up to 400°F for up to 60 minutes.
Microwave Oven	All commercial or residential oven ratings up to 1000 watts.
Freezer Ready	Can be used in quick-freeze commercial freezers down to -40°F.
Pealable Seal	
Dupont® Mylar® Film	
50 OL2 Film	No need to puncture or separate from tray before cooking. Film is easily stripped away after cooking.
50 RL42 Film	For use when more aggressive seal is needed or applying to CPET or PP trays.
Packaging Convenience	3000 linear feet vs. standard 7,000 to 8,000 ft. rolls from film converters. Each roll is boxed for sanitation and protection in shipping.
Machine Application	AFS-10 manually operated film sealer or most automated sealing equipment.
Economical	Less expensive when compared to OPS or board lid options.
Leak Resistant	Prevents spillage of most liquids for take-out applications.

**Clear Advantage™ Lidding Film – Unprinted, Die Cut, Perforated Tear Sheets on 3" Core Roll**

Product Number	Description	Lids/Roll	Lbs./Roll	Cubic Ft./ Roll	Rolls/Carton	Rolls/Pallet
MLC3C0615	100 OLAFT - 0615	5,400	14.25	0.83	1	36
MLC3C0813	100 OLAFT - 0813H/0816H	3,850	10.10	0.83	1	36
MLC3C5613	100 OLAFT - 5613/5613R	5,250	10.95	0.83	1	36
MLC3C5615	100 OLAFT - 5615/4512	5,400	10.85	0.83	1	36
MLC3C5713R	100 OLAFT - 5713R	4,500	11.45	0.83	1	36
MLC3C6816	100 OLAFT - 6816	4,400	13.35	0.83	1	36
MLC4C5615	150 OLAFT - 5615/4512	3,500	9.65	0.83	1	36
MLC4C5713R	150 OLAFT - 5713R	2,950	10.35	0.83	1	36
MLC4C6815	150 OLAFT - 6815	2,500	11.00	0.83	1	36
MLC4C6816	150 OLAFT - 6816	2,800	11.45	0.83	1	36
MLC4C7014	150 OLAFT - 7014	2,200	14.20	0.83	1	36

**Minimum order:** (shipment from Columbus plant) 5 rolls - any combination of above items.

**Freight:** Prepaid to any Continental U.S. destination.

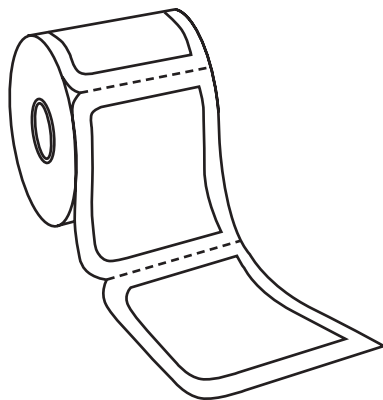

**3000 Linear Foot Roll Lidding Film – 3000 Linear Feet of Film on 3" Core Roll**

Product Number	Description	Lbs./Roll	Cubic Ft./ Roll	Rolls/Carton	Rolls/Pallet	Approximate Seals/roll using length of tray as width of film
MLB1L0650	50 OL2 6 1/2" Web	7.55	0.83	1	36	4512, 5615 = 6,550
MLB1L0725	50 OL2 7 1/4" Web	8.25	0.83	1	36	5611R, 5613, 5613R = 6,550
MLB1L0850	50 OL2 8 1/2" Web	9.55	0.83	1	36	5710, 5713 = 6,400 / 5713R = 6,000 / 6816 = 5,400
MLB1L0950	50 OL2 9 1/2" Web	10.65	0.83	1	36	6815 = 4,900
MLK1L0525	50 RL42 5 1/4" Web	7.25	0.83	1	36	4413 = 7,200
MLK1L0850	50 RL42 8 1/2" Web	11.35	0.83	1	36	5710, 5713 = 6,400 / 5713R = 6,000 / 6816 = 5,400
MLK1L0950	50 RL42 9 1/2" Web	12.55	0.83	1	36	6815 = 4,900
MLK1L1025	50 RL42 10 1/4" Web	13.55	0.83	1	36	7014 = 4,500

**Minimum order:** (shipment from Columbus plant) 5 rolls - any combination of above items.

**Freight:** Prepaid to any Continental U.S. destination.

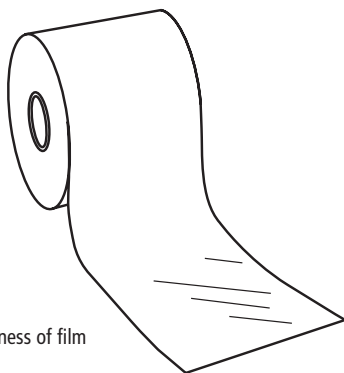

**Numbering Codes:**

50, 100, 150: Gauge, thickness of film

OL/RL: Ovenable Lidding

AF: Anti Fog

T: Treated (for printing)

Requires Sealing Equipment (not supplied by Pactiv). See your Pactiv sales representative for details.

**Pressware® Classic Stoneware™ Dual-Ovenable Paperboard Trays – White w/Brown Specks**

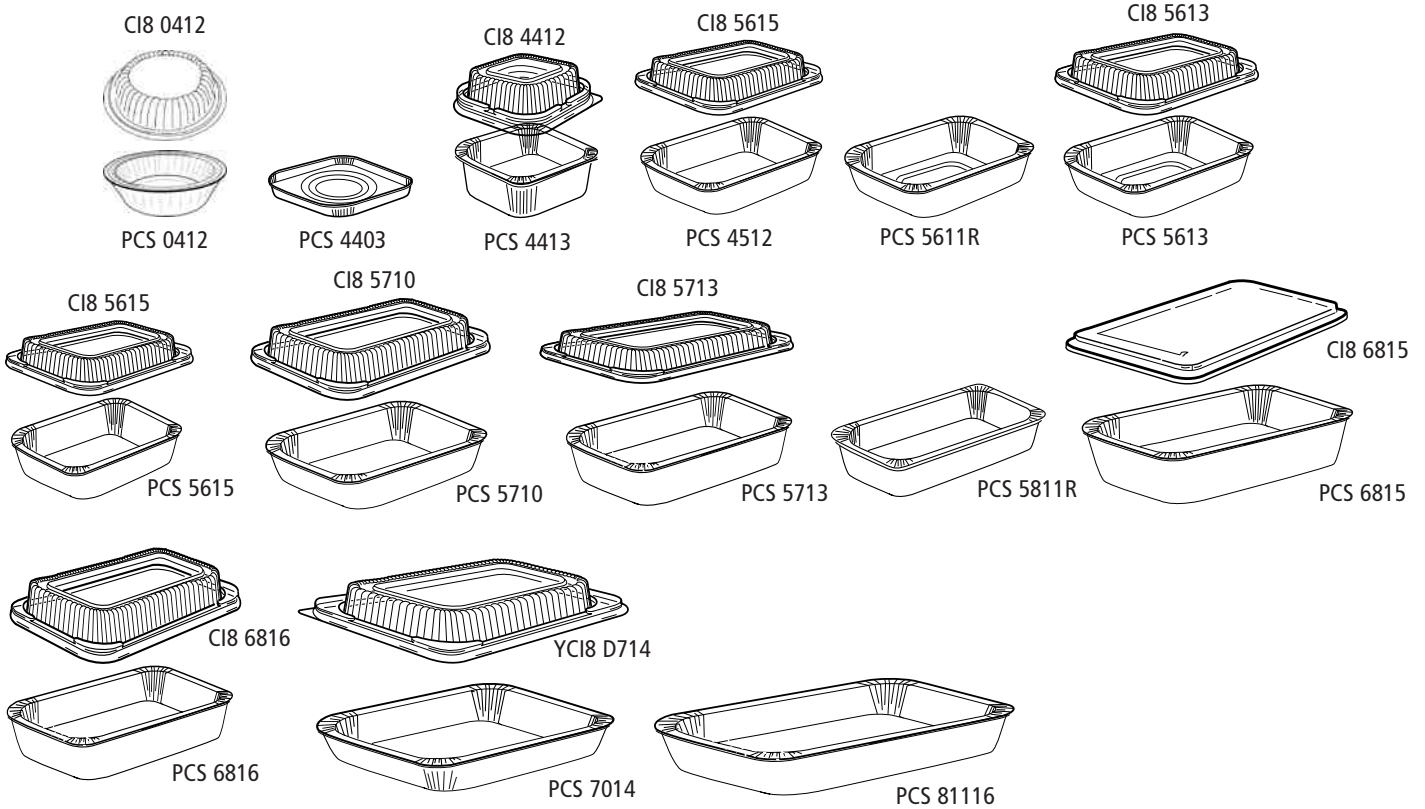

**Pressware® Dual-Ovenable Paperboard Deli Trays & Domes**

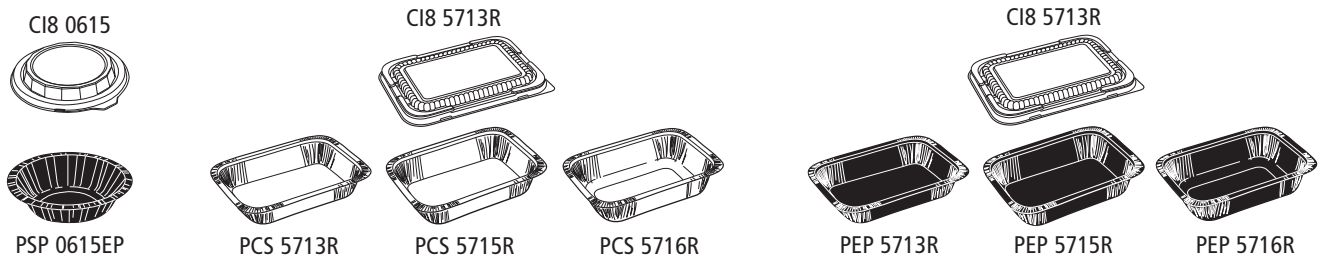

**Pressware® Ebony Premier® Dual-Ovenable Paperboard Trays**

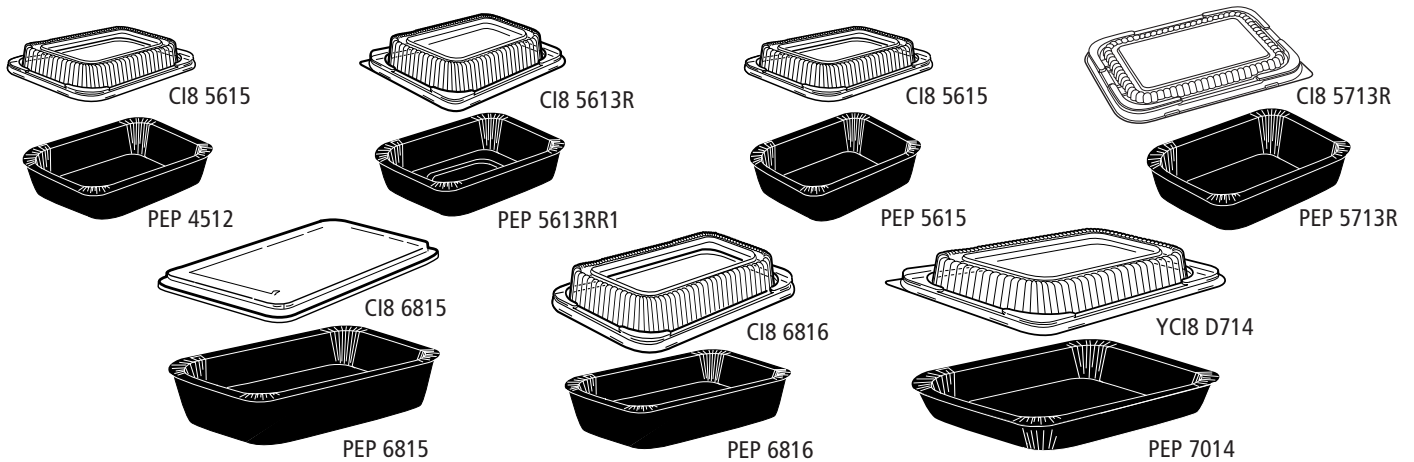

**Pressware® Classic Stoneware™ Dual-Ovenable Paperboard Trays – White w/Brown Specks**

Product Number	Description	Capacity (fl. oz.)	Dimensions (in inches)			Vert. Depth	Cube	Case Approx. Wt.	Case Pack
			Top Out	Top In	Bottom				
PCS 0412	Round Tray	5.70	4 3/16	3 11/16	2 13/16	1 1/4	1.32	17.85	1000
CI8 0412	Clear Round Dome for 0412	--	4 7/16	--	--	9/16	2.30	6.00	1000
PCS 4403	Square Tray (uncoated)	3.50	4 5/16 X 4 5/16	4 5/16 X 4 5/16	4 1/32 X 4 1/32	3/8	2.45	29.98	3000
PCS 4412	Square Tray	5.80	4 3/16 X 4 3/16	3 11/16 X 3 11/16	2 11/16 X 2 11/16	1 1/4	1.91	29.94	1500
CI8 4412	Square Dome Lid for 4412	--	4 1/2 X 4 1/2	--	--	3/4	3.00	9.00	1000
PCS 4413	Square Tray	9.50	4 5/8 X 4 5/8	4 1/8 X 4 1/8	3 3/32 X 3 3/32	1 3/8	1.63	24.90	1000
PCS 4512	Oblong Tray	13.0	4 7/8 X 5 15/16	4 3/8 X 5 7/16	3 17/32 X 4 9/16	1 1/4	2.17	28.21	1000
PCS 5611R	Oblong Tray (rounded corners)	13.8	4 29/32 X 6 17/32	4 13/32 X 6 1/32	3 25/32 X 5 9/32	1 1/8	3.05	30.40	1000
PCS 5613	Oblong Tray	14.5	4 31/32 X 6 9/16	4 15/32 X 6 1/16	3 7/16 X 4 15/16	1 3/8	3.05	35.47	1000
CI8 5613	Oblong Dome Lid for 5613	--	5 7/32 X 6 13/16	--	--	7/8	4.82	13.00	1000
PCS 5613RR1	Oblong Tray (rounded corners)	14.5	4 27/32 X 6 17/32	4 11/32 X 6 1/32	3 1/2 X 5	1 3/8	1.47	17.04	500
CI8 5613R	Obong Dome Lid for 5613R	--	5 3/32 X 6 25/32	--	--	7/8	5.41	15.00	1000
PCS 5615	Oblong Tray	16.8	4 29/32 X 6 3/32	4 13/32 X 5 19/32	3 3/16 X 4 5/16	1 11/16	1.63	18.21	500
CI8 5615	Oblong Dome Lid for 4512 & 5615	--	5 5/32 X 6 11/32	--	--	1/2	3.36	13.00	1000
PCS 5710	Oblong Tray	15.4	5 1/16 X 7 13/16	4 9/16 X 7 5/16	4 1/16 X 6 11/16	1	2.18	17.22	500
CI8 5710	High Dome Lid for 5710 & 5713	--	5 5/16 X 8 1/16	--	--	1 1/8	2.92	11.00	500
PCS 5713	Oblong Tray	20.8	5 1/16 X 7 25/32	4 9/16 X 7 9/32	3 5/8 X 6 5/16	1 3/8	1.30	11.17	250
CI8 5713	Low Dome Lid for 5710 & 5713	--	5 5/16 X 8 1/32	--	--	1/2	1.18	6.00	250
PCS 5811R	Oblong Tray (rounded corners)	20.5	5 29/32 X 8 9/32	5 13/32 X 7 25/32	4 25/32 X 7	1 1/8	2.41	24.99	500
PCS 6815	Oblong Tray	36.7	6 19/32 X 8 3/4	6 3/32 X 8 1/4	5 1/8 X 7 1/16	1 5/8	1.74	16.75	250
CI8 6815	Oblong Dome Lid for 6815	--	6 31/32 X 9 1/8	--	--	1/4	2.22	12.00	250
PCS 6816	Oblong Tray	32.0	6 X 7 7/8	5 1/2 X 7 3/8	4 1/4 X 6 1/8	1 3/4	2.36	27.01	500
CI8 6816	Obong Dome Lid for 6816	--	6 1/4 X 8 1/8	--	--	3/8	2.91	12.00	500
PCS 7014	Oblong Tray	45.0	7 15/32 X 9 31/32	6 31/32 X 9 15/32	6 X 8 5/16	1 1/2	2.05	21.08	250
YC18 D714	Obong Dome Lid for 7014	--	7 23/32 X 10 7/32	--	--	3/4	2.55	11.00	280
PCS 81116	Oblong Tray	64.3	8 9/16 X 11 31/32	8 1/16 X 11 15/32	6 3/8 X 9 5/8	1 3/4	3.93	29.08	250

Do Not Place Dome Lids In Conventional or Microwave Ovens. Do Not Use PRESSWARE® Containers In Toaster Ovens.

**Pressware® Dual-Ovenable Paperboard Deli Trays & Domes**

Product Number	Description	Capacity (fl. oz.)	Dimensions (In Inches)			Cube	Case Approx. Wt.	Case Pack
			Top Out	Top In	Bottom			
PSP 0615EP	Ebony Premier Black Round Deli Bowl	16.5		6 11/32 X 1 5/8		1.60	19.80	500
PCS 5713R	Classic Stoneware Shallow Oblong Deli Tray	21.3		5 7/16 X 7 7/16 X 1 3/8		2.30	22.10	500
PCS 5715R	Classic Stoneware Oblong Deli Tray	23.0		5 3/8 X 7 3/8 X 1 3/4		2.53	22.71	500
PCS 5716R	Classic Stoneware Deep Oblong Deli Tray	25.0		5 7/16 X 7 7/16 X 1 3/4		1.50	13.70	250
PEP 5713R	Ebony Premier Black Shallow Oblong Deli Tray	21.3		5 7/16 X 7 7/16 X 1 3/8		2.30	22.70	500
PEP 5715R	Ebony Premier Black Oblong Deli Tray	23.0		5 3/8 X 7 3/8 X 1 3/4		2.53	22.71	500
PEP 5716R	Ebony Premier Black Deep Oblong Deli Tray	25.0		5 7/16 X 7 7/16 X 1 3/4		1.50	14.10	250
CI8 0615	Clear Dome Lid for 0615 Round Bowl	--		--		3.10	13.40	500
CI8 5713R	Clear Dome Lid for 5713R/5716R Oblong Trays	--		--		2.20	10.00	500

**Pressware® Ebony Premier® Dual-Ovenable Paperboard Trays – Black**

Product Number	Description	Capacity (fl. oz.)	Dimensions (in inches)			Vert. Depth	Cube	Case Approx. Wt.	Case Pack
			Top Out	Top In	Bottom				
PEP 4512	Oblong Tray	13.0	4 7/8 X 5 29/32	4 3/8 X 5 7/16	3 17/32 X 4 9/16	1 1/4	2.17	29.17	1000
PEP 5613RR1	Oblong Tray (rounded corners)	14.5	4 29/32 X 6 17/32	4 11/32 X 6 1/32	3 1/2 X 5	1 3/8	1.47	17.51	500
CI8 5613R	Obong Dome Lid for 5613R	--	5 3/32 X 6 25/32	--	--	7/8	5.41	15.00	1000
PEP 5615	Oblong Tray	16.8	4 15/16 X 6 3/32	4 13/32 X 5 19/32	3 3/16 X 4 5/16	1 11/16	1.63	21.49	500
CI8 5615	Oblong Dome Lid for 4512 & 5615	--	5 5/32 X 6 11/32	--	--	1/2	3.36	13.00	1000
PEP 5713R	Oblong Tray (rounded corners)	21.3	5 15/32 X 7 15/32	4 31/32 X 6 15/16	4 3/32 X 6	1 3/8	2.53	25.70	500
CI8 5713R	Obong Dome Lid for 5713R	--	5 11/16 X 7 11/16	--	--	1/4	2.23	10.00	500
PEP 6815	Oblong Tray	36.7	6 9/16 X 8 3/4	6 3/32 X 8 1/4	5 1/8 X 7 1/16	1 5/8	1.74	19.47	250
CI8 6815	Oblong Dome Lid for 6815	--	6 31/32 X 9 1/8	--	--	1/4	2.22	12.00	250
PEP 6816	Oblong Tray	32.0	6 1/32 X 7 15/16	5 1/2 X 7 3/8	4 1/4 X 6 1/8	1 3/4	2.36	31.52	500
CI8 6816	Obong Dome Lid for 6816	--	6 1/4 X 8 1/8	--	--	3/8	2.91	12.00	500
PEP 7014	Oblong Tray	45.0	7 15/32 X 9 31/32	6 31/32 X 9 15/32	6 X 8 5/16	1 1/2	2.05	21.51	250
YC18 D714	Obong Dome Lid for 7014	--	7 23/32 X 10 7/32	--	--	3/4	2.23	11.00	250

**Clear OPS Dome Lids for *Pressware* Trays**

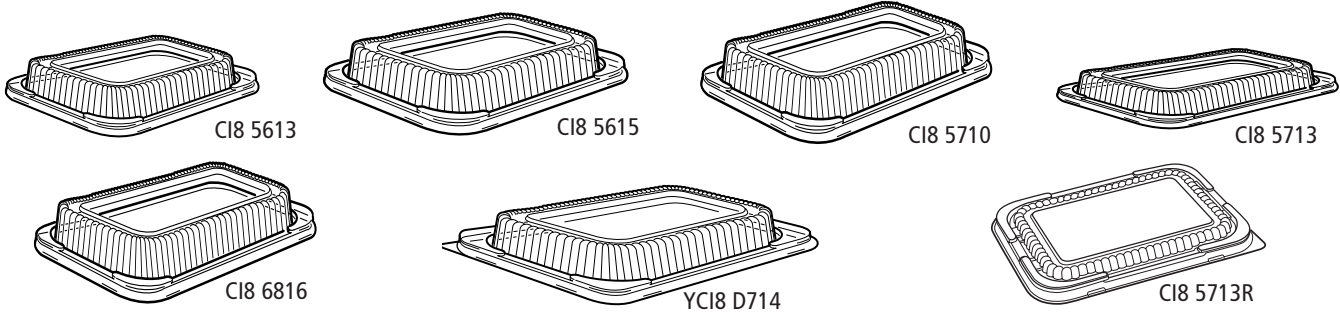

**The Garden Party Produce Hinged Clamshells - PET**

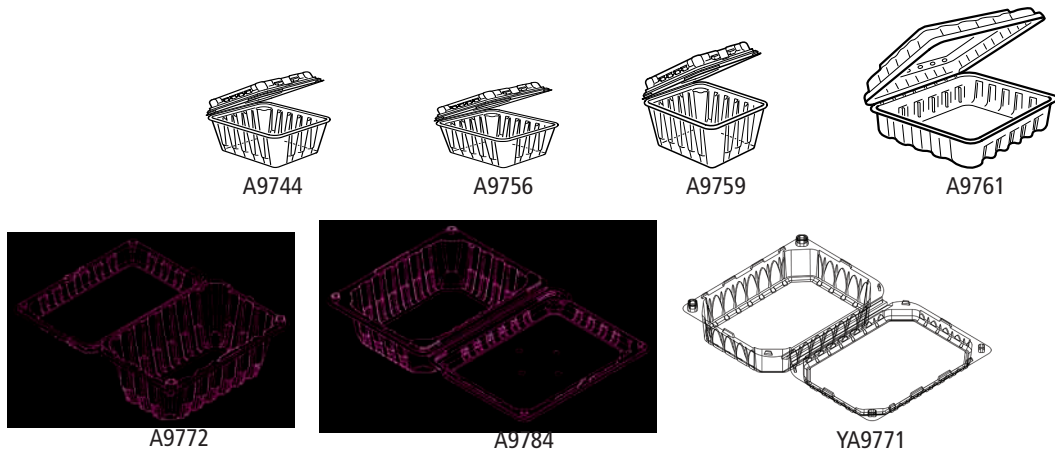

### Clear OPS Dome Lids for *Pressware* Trays

Product Number	Description	Capacity (fl. oz.)	Dimensions (in inches)			Vert. Depth	Cube	Case Approx. Wt.	Case Pack
			Top Out	Top In	Bottom				
CI8 5613	Oblong Dome Lid for 5613	–	5 <sup>7</sup> / <sub>32</sub> x 6 <sup>13</sup> / <sub>16</sub>	–	–	<sup>7</sup> / <sub>8</sub>	4.82	13.0	1000
CI8 5613R	Obong Dome Lid for 5613R	–	5 <sup>3</sup> / <sub>32</sub> x 6 <sup>25</sup> / <sub>32</sub>	–	–	<sup>7</sup> / <sub>8</sub>	5.41	15.0	1000
CI8 5615	Oblong Dome Lid for 5615	–	5 <sup>5</sup> / <sub>32</sub> x 6 <sup>11</sup> / <sub>32</sub>	–	–	<sup>1</sup> / <sub>2</sub>	3.36	13.0	1000
CI8 5710	High Dome Lid for 5710	–	5 <sup>5</sup> / <sub>16</sub> x 8 <sup>1</sup> / <sub>16</sub>	–	–	1 <sup>1</sup> / <sub>8</sub>	2.92	11.0	500
CI8 5713	Low Dome Lid for 5713	–	5 <sup>5</sup> / <sub>16</sub> x 8 <sup>1</sup> / <sub>32</sub>	–	–	<sup>1</sup> / <sub>2</sub>	1.18	6.00	250
CI8 5713R	Obong Dome Lid for 5713R, 5716R	–	5 <sup>11</sup> / <sub>16</sub> x 7 <sup>11</sup> / <sub>16</sub>	–	–	<sup>1</sup> / <sub>4</sub>	2.23	10.0	500
CI8 6815	Oblong Dome Lid for 6815	–	6 <sup>3</sup> / <sub>32</sub> x 9 <sup>1</sup> / <sub>8</sub>	–	–	<sup>1</sup> / <sub>4</sub>	2.22	12.0	250
CI8 6816	Oblong Dome Lid for 6816	–	6 <sup>1</sup> / <sub>4</sub> x 8 <sup>1</sup> / <sub>8</sub>	–	–	<sup>3</sup> / <sub>8</sub>	2.91	12.0	500
YCI8 D714	Oblong Dome Lid for 7014	–	7 <sup>23</sup> / <sub>32</sub> x 10 <sup>7</sup> / <sub>32</sub>	–	–	<sup>3</sup> / <sub>4</sub>	2.23	11.0	250

Do Not Place Dome Lids In Conventional or Microwave Ovens

### The Garden Party Produce Hinged Clamshells - PET

Product Number	Description	Dimensions (in inches)		Case Cube	Case Pack	Cases/Pallet	Cases/Truck Load
		Top Out	Vert. Depth (Closed)				
A9744	6 oz. Clear Berry Clamshell	4 <sup>3</sup> / <sub>4</sub> x 4 <sup>7</sup> / <sub>16</sub>	1 <sup>3</sup> / <sub>4</sub>	4.09	576	28	840
A9756	4.4 oz. Clear Berry Clamshell	4 <sup>3</sup> / <sub>4</sub> x 4 <sup>7</sup> / <sub>16</sub>	1 <sup>1</sup> / <sub>2</sub>	4.09	576	28	840
A9759	1 Pint Clear Clamshell	5 x 4 <sup>3</sup> / <sub>8</sub>	2 <sup>13</sup> / <sub>16</sub>	3.68	480	28	840
A9761	6 oz./1/2 Pint Clear Berry Clamshell	4 <sup>7</sup> / <sub>8</sub> x 4 <sup>15</sup> / <sub>16</sub>	1 <sup>3</sup> / <sub>4</sub>	4.29	600	30	730
A9762	1 lb. Clear Strawberry Clamshell	7 <sup>3</sup> / <sub>8</sub> x 4 <sup>7</sup> / <sub>8</sub>	3 <sup>3</sup> / <sub>8</sub>	4.24	344	30	780
A9769	4 lb. Clear Table Grape Clamshell	11 x 7 <sup>1</sup> / <sub>8</sub>	5	2.54	100	40	1,200
YA9770	2 lb. Clear Table Grape Clamshell	7 <sup>3</sup> / <sub>8</sub> x 5 <sup>3</sup> / <sub>4</sub>	5 <sup>1</sup> / <sub>16</sub>	3.47	240	30	900
YA9771	1 lb. Clear Mini Tomato Clamshell	7 <sup>3</sup> / <sub>8</sub> x 5 <sup>3</sup> / <sub>4</sub>	2 <sup>1</sup> / <sub>8</sub>	4.72	400	24	720
A9772	1 lb. Clear Berry Clamshell - Button Lock	7 <sup>3</sup> / <sub>8</sub> x 4 <sup>7</sup> / <sub>8</sub>	3 <sup>1</sup> / <sub>2</sub>	2.40	344	24	720
YA9772	1 lb. Clear Berry Clamshell - Button Lock	7 <sup>3</sup> / <sub>8</sub> x 4 <sup>7</sup> / <sub>8</sub>	3 <sup>1</sup> / <sub>2</sub>	4.48	416	24	720
A9777	18 oz. Clear Blueberry Clamshell	4 <sup>7</sup> / <sub>8</sub> x 7 <sup>3</sup> / <sub>8</sub>	2 <sup>3</sup> / <sub>4</sub>	4.07	288	30	750
A9777LO	18 oz. Clear Blueberry Low Profile Clamshell	NEW in 2010					
A9779	2 lb. Clear Blueberry Modular Clamshell	7 <sup>1</sup> / <sub>4</sub> x 7 <sup>1</sup> / <sub>2</sub>	3 <sup>1</sup> / <sub>16</sub>	3.31	168	30	900
A9784	2 lb. Clear Berry clamshell	9 <sup>1</sup> / <sub>4</sub> x 7 <sup>1</sup> / <sub>4</sub>	3 <sup>3</sup> / <sub>8</sub>	4.70	180	24	720
A9785	2 lb. Clear Modular Berry Clamshell	11 x 7 <sup>1</sup> / <sub>8</sub>	3 <sup>5</sup> / <sub>16</sub>	4.66	200	24	672
A9786	2.75 lb. Clear Modular Blueberry Clamshell	NEW in 2010					
A9788	4 lb. Clear Modular Strawberry Clamshell	NEW in 2010					
A9792	1 lb. Clear Modular Berry Clamshell - FL	7 <sup>1</sup> / <sub>4</sub> x 5 <sup>9</sup> / <sub>16</sub>	2 <sup>7</sup> / <sub>8</sub>	4.03	344	24	720
A9793	1 lb. Clear Modular Berry Clamshell - CA	7 <sup>1</sup> / <sub>4</sub> x 5 <sup>9</sup> / <sub>16</sub>	3 <sup>3</sup> / <sub>16</sub>	4.03	344	24	720
A9786T	2.75 lb. Clear Blueberry Modular Clamshell	11 <sup>1</sup> / <sub>16</sub> x 7 <sup>3</sup> / <sub>32</sub>	3 <sup>3</sup> / <sub>16</sub>	4.82	200	20	540

## The Garden Party® Berigard® Quart, Pint & Half Pint Containers

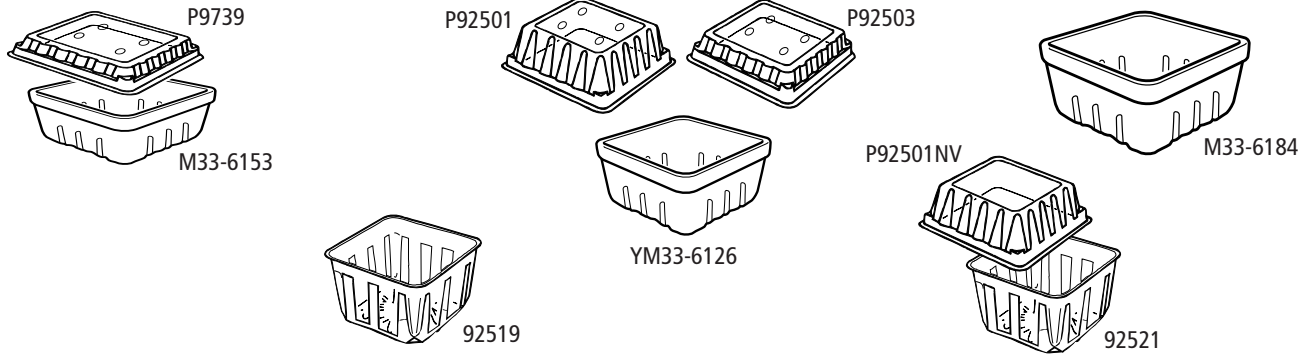

## Bulk Pack Polypropylene Trays

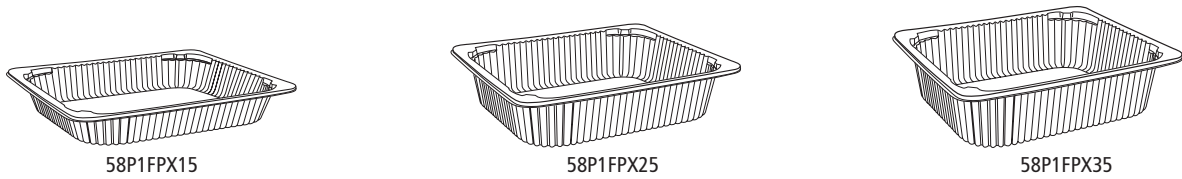



## The Garden Party® Berigard® Pint & Half Pint Containers

Product Number	Description	Dimensions (in inches)			Vert. Depth	Case Cube	Case Pack
		Top Out	Top In	Bottom			
M33-6184	2 BB Green Molded Fiber Quart Container	5 1/2 x 5 1/2	5 5/16 x 5 5/16	4 3/8 x 4 3/8	3 1/4	2.90	250
P92503	Shallow Dome Lid - 1 Pint / 1/2 Pint	4 3/8 x 4 3/8	4 1/4 x 4 1/4	3 3/4 x 3 3/4	1	4.17	1200
P92503NV	Shallow Dome Lid - 1 Pint / 1/2 Pint Nonvented	4 3/8 x 4 3/8	4 1/4 x 4 1/4	3 3/4 x 3 3/4	1	4.17	1200
P92501	1 Pint Clear Dome	4 3/8 x 4 3/8	--	--	1 1/2	3.55	1200
P92501NV	1 Pint Clear Dome Nonvented	4 3/8 x 4 3/8	--	--	1 1/2	3.55	1200
92519	1 Pint Clear Basket	4 1/8 x 4 1/8	3 7/8 x 3 7/8	3 5/16 x 3 5/16	2 5/8	3.90	1200
92521	1 Pint Clear Sprout Container	4 1/8 x 4 1/8	3 7/8 x 3 7/8	3 5/16 x 3 5/16	2 5/8	3.90	1200
YM33-6126	1 BBS Green Molded Fiber Container - 1 Pint	4 1/8 x 4 1/8	4 x 4	3 1/4 x 3 1/4	2 7/8	4.50	420
M33-6153	1/2 BBL Green Molded Fiber Containe - 1/2 Pint	3 7/8 x 3 7/8	3 3/4 x 3 3/4	3 3/16 x 3 3/16	1 3/4	2.30	600
P9739	1/2 BBL Clear Plastic Lid - 1/2 Pint	4 1/8 x 4 1/8	--	--	1 1/2	4.20	1200
92520	1/2 Pint Clear Basket	4 3/16 x 4 3/16	3 7/8 x 3 7/8	3 5/8 x 3 5/8	1 1/2	3.59	1200

## Bulk Pack Polypropylene Trays

Product Number	Description	Outside Dimensions (in inches)	Pallet Cube	Pallet Weight (lbs.)	Pallet Pack
1240TW	White Tomato Tray w/Reservoir Bottom	12 x 5 x 4	3.43	16.0	140
1240TWE6	White Tomato Tray w/Reservoir Bottom and Laminate	12 x 5 x 4	3.43	16.0	140
58P1FPX15*	White Family Pack Tray w/Laminate	12 3/8 x 10 1/4 x 1 1/2	47.80	165.8	1,260
89200TB	Black Tomato Tray w/Reservoir Bottom	12.39 x 10.24 x 2.0	3.43	16.0	90
89200TBE6	Black Tomato Tray w/Reservoir Bottom and Laminate	12.39 x 10.24 x 2.0	3.43	16.0	90
58P1FPX25	White Family Pack Tray w/Laminate	12 3/8 x 10 1/4 x 2 1/2	47.80	194.2	1,260
8925TW	White Tomato Tray w/Reservoir Bottom	12.39 x 10.24 x 3.0	3.43	17.5	90
8925TBR	Black Tomato Tray w/Reservoir Bottom	12.39 x 10.24 x 3.0	3.43	17.5	90
8925TBE6	Black Tomato Tray w/Reservoir Bottom and Laminate	12.39 x 10.24 x 3.0	3.43	17.5	90
58P1FPX35	White Family Pack Tray w/Laminate	12 3/8 x 10 1/4 x 3 1/2	47.80	206.6	1,260
58P9X37T*	Black Tomato Tray	12 3/8 x 10 1/4 x 3.7	53.50	206.6	1,260

\* Made to order. Please contact your Pactiv sales representative for more information.

## APET Round Deli Containers & Lids

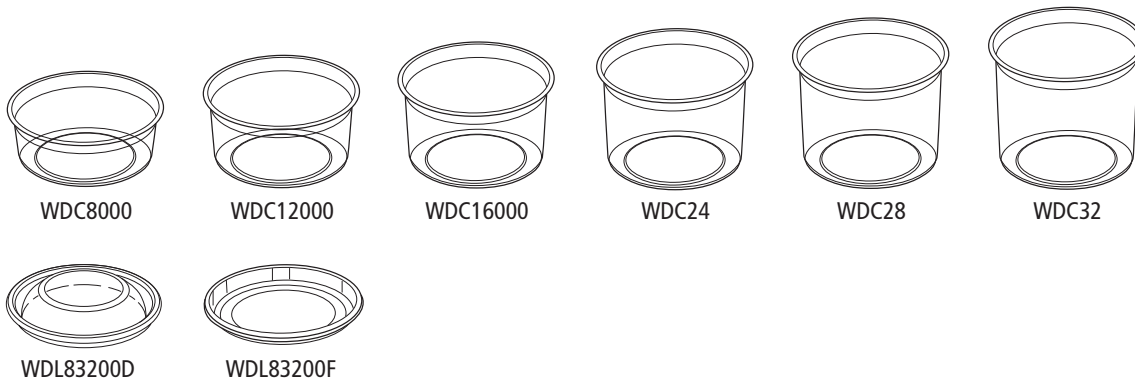

## APET 7" Round Tubs – Bulk

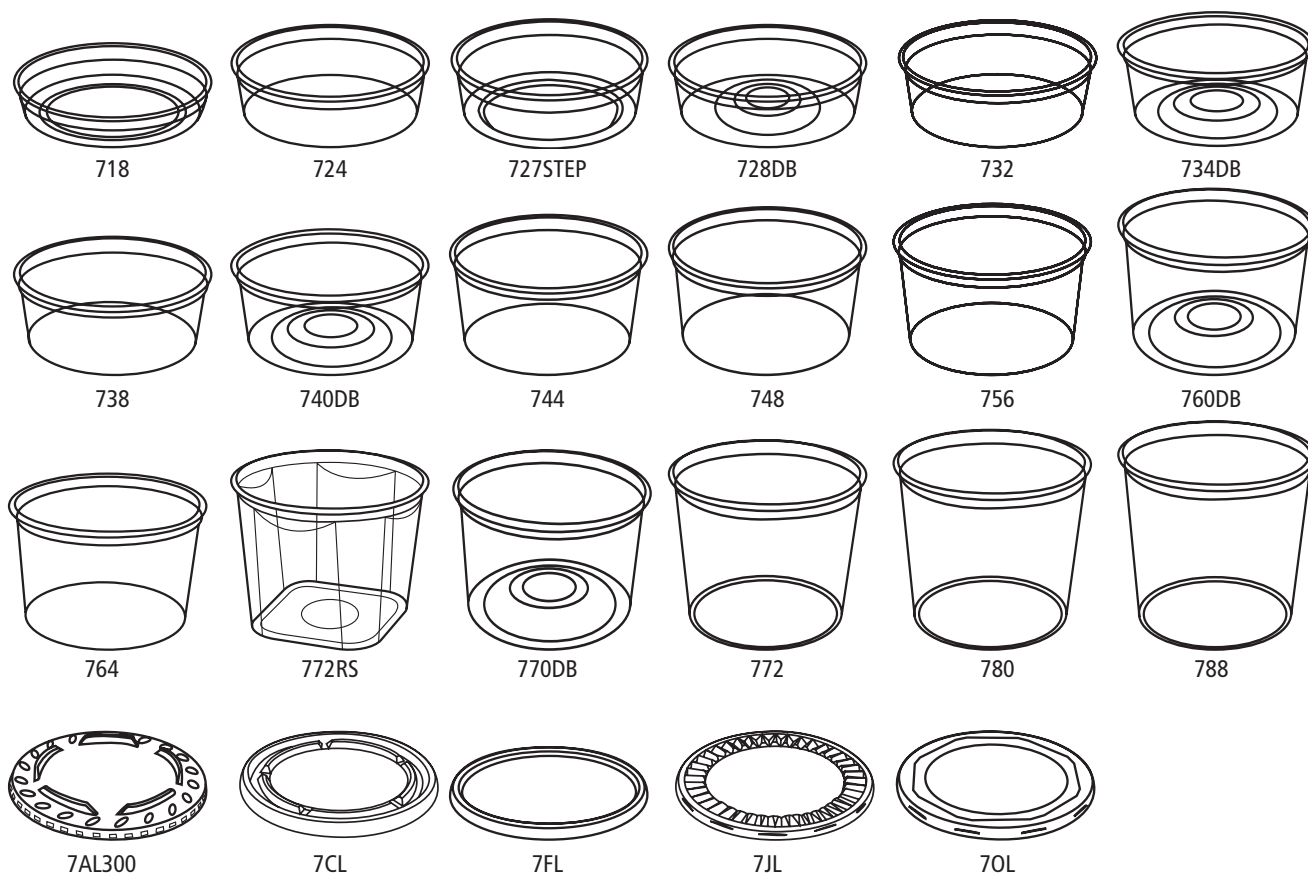

## APET Salad/Sandwich Trays – Bases & Lids



### APET Round Deli Containers & Lids

Product Number	Description	Diameter	Depth	Case Pack	Case Weight	Case Cube
YWDC8000	8 oz Deli Round Container	4 <sup>3</sup> / <sub>8</sub>	1 <sup>5</sup> / <sub>8</sub>	1000	22.92	5.96
YWDC12000	12 oz Deli Round Container	4 <sup>3</sup> / <sub>8</sub>	2 <sup>1</sup> / <sub>4</sub>	1000	30.32	5.76
WDC16000	16 oz Deli Round Container			1000	37.15	6.29
YWDC24	24 oz Deli Round Container	4 <sup>3</sup> / <sub>8</sub>	4 <sup>1</sup> / <sub>8</sub>	500	24.65	4.10
WDC28	28 oz Deli Round Container	4 <sup>1</sup> / <sub>4</sub>	4 <sup>5</sup> / <sub>8</sub>	500	25.99	4.38
WDC32	32 oz Deli Round Container	4 <sup>1</sup> / <sub>4</sub>	5 <sup>3</sup> / <sub>4</sub>	500	32.01	4.38
WDC16L832K	16 oz Deli Round with Flat Lid - Combo Pack			250	13.89	3.00
YWDC32L832K	32 oz Deli Round with Flat Lid - Combo Pack	4 <sup>1</sup> / <sub>4</sub>	5 <sup>3</sup> / <sub>4</sub>	250	20.11	3.47
<b>Lids</b>						
WDL83200D	Dome Lid for Round Deli	4 <sup>1</sup> / <sub>4</sub>	--	1000	17.23	5.45
WDL83200F	Flat Lid for Round Deli	4 <sup>1</sup> / <sub>4</sub>	--	1000	12.97	5.45

### APET FanFare™ Round Containers & Lids – 6 3/4"

Product Number	Description	Outside Dimensions (in inches)	Case Cube	Case Weight	Case Pack
718	18 oz. Clear Round Tub	6 <sup>5</sup> / <sub>6</sub> x 1 <sup>1</sup> / <sub>4</sub>	4.60	12.00	300
724	24 oz. Clear Round Tub	6 <sup>5</sup> / <sub>6</sub> x 1 <sup>1</sup> / <sub>2</sub>	4.60	14.00	300
727STEP	27 oz. Clear Round Tub	6 <sup>5</sup> / <sub>6</sub> x 1 <sup>5</sup> / <sub>8</sub>	4.60	14.00	300
728DB	28 oz. Clear Round Tub w/Dome Bottom	6 <sup>5</sup> / <sub>6</sub> x 1 <sup>3</sup> / <sub>4</sub>	4.60	14.00	300
729DB	29 oz. Clear Round Tub w/Dome Bottom	6 <sup>5</sup> / <sub>6</sub> x 1 <sup>7</sup> / <sub>8</sub>	4.60	15.00	300
732	32 oz. Clear Round Tub	6 <sup>5</sup> / <sub>6</sub> x 2	4.60	14.00	300
734DB	34 oz. Clear Round Tub w/Dome Bottom	6 <sup>5</sup> / <sub>6</sub> x 2 <sup>1</sup> / <sub>2</sub>	4.60	19.00	300
738	38 oz. Clear Round Tub	6 <sup>5</sup> / <sub>6</sub> x 2 <sup>1</sup> / <sub>2</sub>	5.20	19.00	300
739DB	39 oz. Clear Round Tub w/High Dome Bottom	6 <sup>5</sup> / <sub>6</sub> x 3	5.20	21.00	300
740DB	40 oz. Clear Round Tub w/Dome Bottom	6 <sup>5</sup> / <sub>6</sub> x 3	5.20	21.00	300
744	44 oz. Clear Round Tub	6 <sup>5</sup> / <sub>6</sub> x 3	5.20	21.00	300
748	48 oz. Clear Round Tub	6 <sup>5</sup> / <sub>6</sub> x 3 <sup>1</sup> / <sub>8</sub>	5.20	21.00	300
756	56 oz. Clear Round Tub	6 <sup>5</sup> / <sub>6</sub> x 3 <sup>1</sup> / <sub>4</sub>	5.20	25.00	300
760DB	60 oz. Clear Round Tub w/Dome Bottom	6 <sup>5</sup> / <sub>6</sub> x 4	5.20	28.00	300
764	64 oz. Clear Round Tub	6 <sup>5</sup> / <sub>6</sub> x 4 <sup>1</sup> / <sub>8</sub>	5.20	28.00	300
772RS	66 oz. Clear Round Tub w/Square Bottom	6 <sup>5</sup> / <sub>6</sub> x 4 <sup>3</sup> / <sub>4</sub>	5.20	29.00	300
770DB	70 oz. Clear Round Tub w/Dome Bottom	6 <sup>5</sup> / <sub>6</sub> x 5	5.20	29.00	300
772	72 oz. Clear Round Tub	6 <sup>5</sup> / <sub>6</sub> x 5	5.20	29.00	300
780	80 oz. Clear Round Tub	6 <sup>5</sup> / <sub>6</sub> x 5 <sup>1</sup> / <sub>2</sub>	5.20	36.00	300
788	88 oz. Clear Round Tub	6 <sup>5</sup> / <sub>6</sub> x 6	5.20	36.00	288
<b>Lids</b>					
7AL300	7" Auto Lid	7"	2.60	10.00	300
7CL	7" Crown Lid	7"	2.60	10.00	300
7FL	7" Flat Lid	7"	2.60	10.00	300
7JL	7" Jewel Lid	7"	2.60	10.00	300
7OL	7" Octagonal Lid	7"	2.60	10.00	300

### APET Salad/Sandwich Trays – Bases & Lids

Product Number	Description	Dimensions (in inches)	Case Pack	Case Weight	Case Cube
MAPI175	Clear Plastic Tray	8 5/8 x 6 5/8 x 1 3/4	360	18.42	4.66
MAPI225	Clear Plastic Tray	8 5/8 x 6 5/8 x 2 1/4	360	24.28	5.51
MAPI3	Clear Plastic Tray	8 5/8 x 6 5/8 x 3	360	24.16	4.66
<b>Lids</b>					
MAPIFL	Clear Plastic Flat Lid	--	360	17.21	3.55
MAPIDL	Clear Plastic Dome Lid	--	360	17.63	4.53

## APET 7" Octagonal Tubs – Bulk

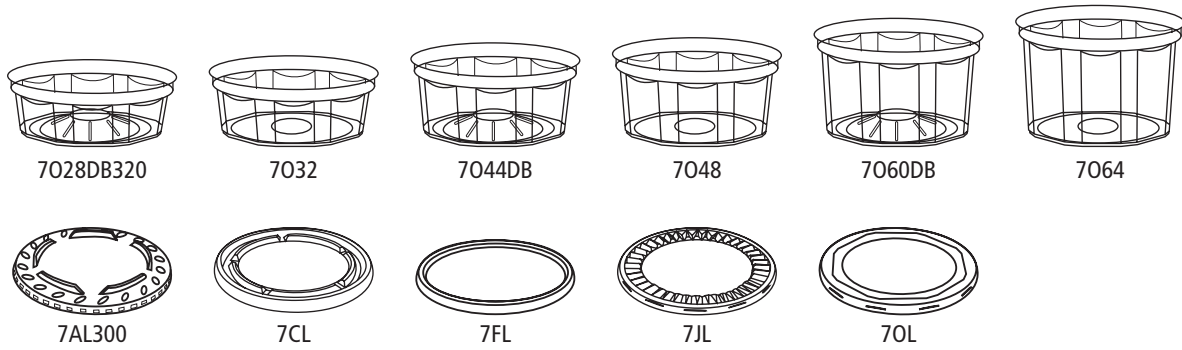

## APET 7" Round Compartmented Tubs – Bulk

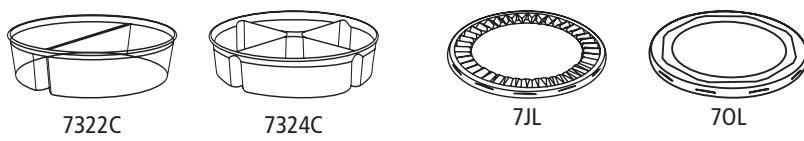

## APET 8" Round Tub – Bulk

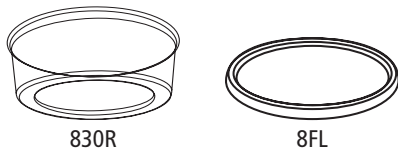

## APET 10" Round Tubs – Bulk

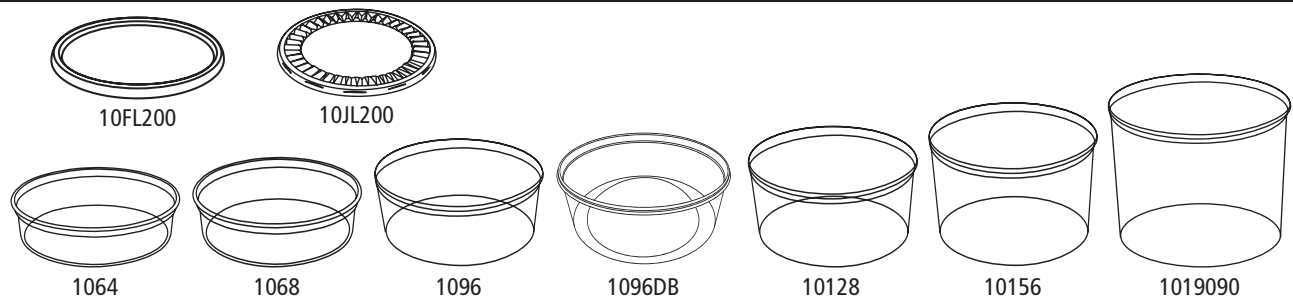

## APET 10" Round Compartmented Tubs – Center Snap – Bulk

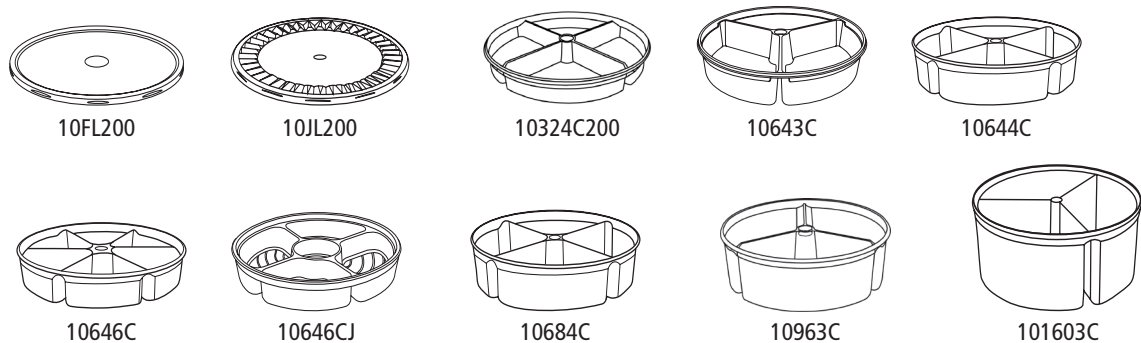

### APET 7" Octagonal Tubs – Bulk

Product Number	Description	Outside Dimensions (in inches)	Case Cube	Case Weight	Case Pack
7028DB320	28 oz. Octagonal Clear Tub w/Dome Bottom	6 5/8 x 1 7/8	5.20	15.00	320
7032	32 oz. Octagonal Clear Tub	6 5/8 x 2	4.60	14.00	300
7044DB	44 oz. Octagonal Clear Tub w/Dome Bottom	6 5/8 x 3	5.20	21.00	300
7048	48 oz. Octagonal Clear Tub	6 5/8 x 3 1/8	5.20	21.00	300
7060DB	60 oz. Octagonal Clear Tub w/Dome Bottom	6 5/8 x 4 1/8	5.20	28.00	300
7064	64 oz. Octagonal Clear Tub	6 5/8 x 4 1/8	5.20	28.00	300

#### Lids

7AL300	7" Auto Lid	7	2.60	10.00	300
7CL	7" Crown Lid	7	2.60	10.00	300
7FL	7" Flat Lid	7	2.60	10.00	300
7JL	7" Jewel Lid	7	2.60	10.00	300
7OL	7" Octagonal Lid	7	2.60	10.00	300

### APET 7" Round Compartmented Tubs – Bulk

Product Number	Description	Outside Dimensions (in inches)	Case Cube	Case Weight	Case Pack
7322C	32 oz. Round Clear Tub w/2-Compartments	6 5/8 x 2	4.60	19.00	300
7324C	32 oz. Round Clear Tub w/4-Compartments	6 5/8 x 2	4.60	19.00	300

#### Lids

7JL	7" Jewel Lid	7	2.60	10.00	300
7OL	7" Octagonal Lid	7	2.60	10.00	300

### APET 8" Round Tub – Bulk

Product Number	Description	Outside Dimensions (in inches)	Case Cube	Case Weight	Case Pack
830R	60 oz. Round Clear Tub	7 3/4 x 3	3.20	16.00	200

#### Lids

8FL	8" Flat Lid	8	3.00	9.00	200
-----	-------------	---	------	------	-----

### APET 10" Round Tubs – Bulk

Product Number	Description	Outside Dimensions (in inches)	Case Cube	Case Weight	Case Pack
1064	64 oz. Round Clear Tub	9 3/4 x 2	3.40	11.00	100
1068	68 oz. Round Clear Tub	9 3/4 x 2 1/4	3.40	13.00	100
1096	96 oz. Round Clear Tub	9 3/4 x 2 7/8	3.40	14.00	100
1096DB	96 oz. Round Clear Tub w/Dome Bottom	9 3/4 x 2 7/8	3.40	14.00	100
10128	128 oz. Round Clear Tub	9 3/4 x 3 3/4	3.40	15.00	100
10145	145 oz. Round Clear Tub	9 3/4 x 4 3/8	3.40	16.00	100
10156	156 oz. Round Clear Tub	9 3/4 x 4 1/2	3.40	17.00	100
1019090	190 oz. Round Clear Tub	9 3/4 x 5 3/4	3.40	22.00	90

#### Lids

10FL200	10" Flat Lid	9 7/8	3.40	14.00	200
10JL200	10" Jewel Lid	9 7/8	3.40	14.00	200

### APET 10" Round Compartmented Tubs – Center Snap – Bulk

Product Number	Description	Outside Dimensions (in inches)	Case Cube	Case Weight	Case Pack
10324C200	32 oz. Round Clear Tub w/ 4 Compartments	9 3/4 x 1 1/4	4.50	22.00	200
10643C	64 oz. Round Clear Tub w/ 3 Compartments	9 3/4 x 1 3/4	3.40	14.00	100
10644C	64 oz. Round Clear Tub w/ 4 Compartments	9 3/4 x 1 3/4	3.40	14.00	100
10646C	64 oz. Round Clear Tub w/ 6 Compartments	9 3/4 x 1 3/4	3.40	14.00	100
10646CJ	64 oz. Round Clear Tub w/ 6 Compartments w/ Juice Trap	9 3/4 x 2	3.40	14.00	100
10684C	68 oz. Round Clear Tub w/ 4 Compartments	9 3/4 x 2 1/4	3.40	14.00	100
10963C	96 oz. Round Clear Tub w/ 3 Compartments	9 3/4 x 3	3.40	16.00	100
101603C	160 oz. Round Clear Tub w/ 3 Compartments	9 3/4 x 4 5/8	3.40	24.00	100

#### Lids

10FLC200	10" Flat Lid w/ Center Snap	9 7/8	3.40	14.00	200
10JLC200	10" Jewel Lid w/ Center Snap	9 7/8	3.40	14.00	200

**APET 10" Round Compartmented Tubs – Bulk**

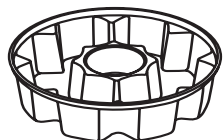

1096AB

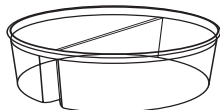

1096AB

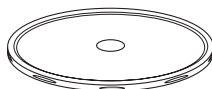

10FL200

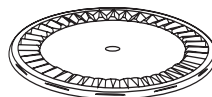

10JL200

**APET Produce Platter Collection – Bases & Lids**

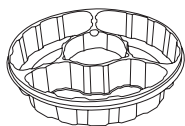

PP01



PP05

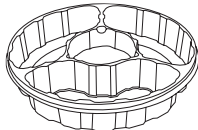

PP09

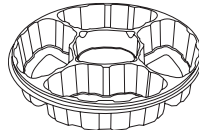

PP17

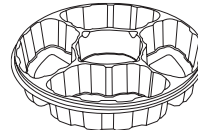

PP25

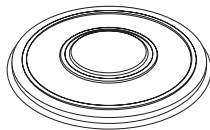
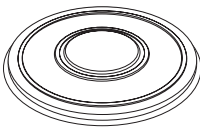
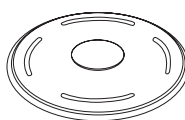

PP0531

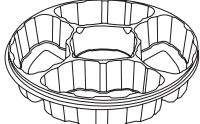

PP2533

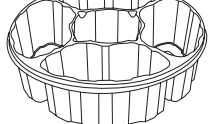

YPP2933

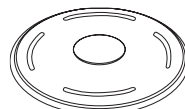

PP31

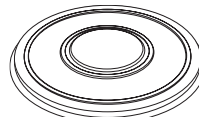

PP33

**APET Deep Draw Tubs & Lid – 7 1/2" Round**

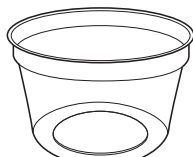

TRL1102

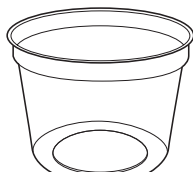

TRL1128

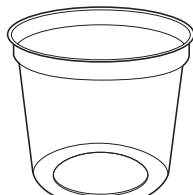

TRL1160



TRL1160

**APET Deep Draw Tubs & Lids – 6 3/4" Square**

SLS2400PC  
SLS500CL

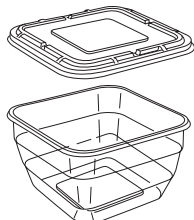

STS1016

SLS2400PC  
SLS500CL

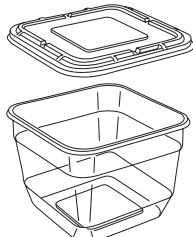

STS24

SLS2400PC  
SLS500CL

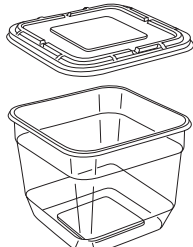

STS1032

SLS2400PC  
SLS500CL

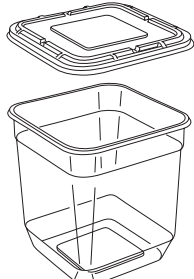

STS1080

SLS2400PC  
SLS500CL

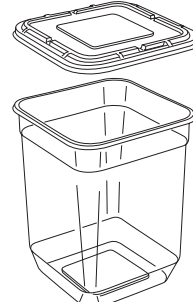

STS1134

### APET 10" Round Compartmented Tubs – Bulk

Product Number	Description	Outside Dimensions (in inches)	Case Cube	Case Weight	Case Pack
1096AB	96 oz. Round Clear Cookie Cell Tub	9 3/4 x 3	3.40	14.00	100
10962C	96 oz. Round Clear Tub w/ 2-Compartments	9 3/4 x 3 5/8	3.40	16.00	100
<b>Lids</b>					
10FL	10" Flat Lid	9 7/8	3.40	14.00	200
10JL200	10" Jewel Lid	9 7/8	3.40	14.00	200

### APET Produce Platter Collection – Bases & Lids

Product Number	Description	Dimensions (in inches)	Case Pack	Case Weight	Case Cube
PP01	10.25" 3 Cmpt. Produce Platter with Dip Cup	10 1/4 x 2 1/2 x 1 1/2	200	27.56	4.83
PP05	10.25" 4 Cmpt. Produce Platter with Dip Cup	10 1/4 x 2 3/4 x 1 1/2	200	29.02	5.36
PP09	13" 3 Cmpt. produce Platter with Dip Cup	13 x 2 5/8 x 1 9/16	100	27.22	3.85
PP17	13" 4 Cmpt. Produce Platter with Dip Cup	13 x 2 5/8 x 1 9/16	100	25.14	3.85
PP25	13" 4 Cmpt. Produce Platter with Dip Cup	13 x 2 5/8 x 2 1/4	100	26.50	3.85
PP29	13" 4 Cmpt. Produce Platter with Dip Cup	13 x 4 x 3	100	30.73	4.21
PP43	10.25" 4 Cmpt. Produce Platter with Dip Cup with Juice Catcher	10 1/4 x 2 3/4 x 1 1/2	200	29.94	5.36
PP0531	10.25" 4 Cmpt. Produce Platter with Dip Cup and Lid	10 1/4 x 2 3/4 x 1 1/2	100	24.74	5.36
PP2133	13" 4 Cmpt. Produce Platter with Dip Cup and Lid	13 x 2 5/8 x 2 1/4	50	29.06	3.48
PP2533	13" 4 Cmpt. Produce Platter with Dip Cup and Lid	13 x 2 3/4 x 2 1/4	50	20.61	3.48
YPP2933	13" 4 Cmpt. Product Platter with Dip Cup and Lid	13 x 4 x 3	25	11.79	2.08
<b>Lids</b>					
PP31	10.25" Lid	--	200	16.75	3.11
PP33	13" Lid	--	200	24.76	5.34

### APET Deep Draw Tubs & Lid – 7 1/2" Round

Product Number	Description	Depth	Case Pack	Case Weight	Case Cube
<b>Bases</b>					
TRL1102	102 oz Round Deep Draw Tub	5.25"	570	91.73	24.46
TRL1128	128 oz Round Deep Draw Tub	6.82"	510	85.26	24.46
TRL1160	160 oz Round Deep Draw Tub	8.5"	450	107.88	24.46
<b>Lid</b>					
TRLID	Deep Draw Lid Round	--	2016	103.47	24.46

### APET Deep Draw Tubs & Lids – 6 3/4" Square

Product Number	Description	Depth	Case Pack	Case Weight	Case Cube
<b>Bases</b>					
STS1016	16 oz. Deep Draw Square Tub	1"	500	22.19	4.26
STS24	24 oz. Deep Draw Square Tub	1.5"	350	19.71	4.26
STS1032	32 oz. Deep Draw Square Tub	2"	340	23.86	4.26
STS1080	80 oz. Deep Draw Square Tub	4"	595	85.17	24.46
STS1134	134 oz. Deep Draw Square Tub	7"	490	93.90	24.46
<b>Lids</b>					
SLS2400PC	Clear Plain Square Lid	--	2400	106.71	24.46
SLS500CL	Clear Square Lid - WAY	--	500	19.95	4.90

## APET Deep Draw Tubs & Lids – 7 1/2" Square

SLL2016CL  
SII2025DC



STL1130

SLL2016CL  
SII2025DC

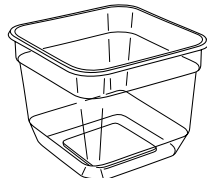

STL1142

SLL2016CL  
SII2025DC

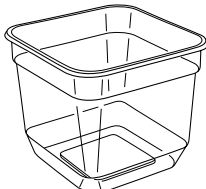

STL1160

SLL2016CL  
SII2025DC

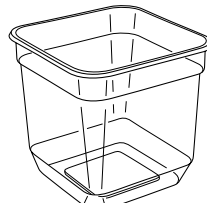

STL1175

## APET 7.5" Square Shelf Savers® – Bulk



75S128

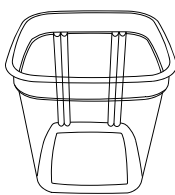

75S175

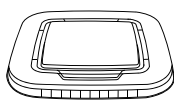

75SFL

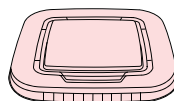

75SFLTRED

## APET Tamper-Resistant™ Packaging – Bulk & Combo



4H10JDPLTE



4H10JILTE

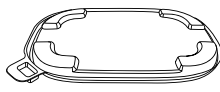

5X7ILTE

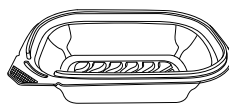

5X714PJTE



7564LRLTE



### APET Deep Draw Tubs & Lids – 7 1/2" Square

Product Number	Description	Depth	Case Pack	Case Weight	Case Cube
<b>Bases</b>					
STL1130	130 oz. Square Deep Draw Tub	5.75"	510	111.85	24.46
STL1142	142 oz. Square Deep Draw Tub	6.5"	510	102.74	24.46
STL1160	160 oz. Square Deep Draw Tub	7.375"	450	120.82	24.46
STL1175	175 oz. Square Deep Draw Tub	8.125"	450	125.79	24.46
<b>Lids</b>					
SLL2016CL	Clear Square Lid	--	2016	156.96	24.46
SIL2025DC	Clear Square Denestable Lid	--	2025	157.63	24.46

### APET 7.5" Square Shelf Savers® – Bulk

Product Number	Description	Outside Dimensions (in inches)	Case Cube	Case Weight	Case Pack
75S128	128 oz. APET Square Clear Container	7 1/2 x 7 1/2 x 5 3/4	50.00	180.00	1,080
75S175	175 oz. APET Square Clear Container	7 1/2 x 7 1/2 x 8 1/8	50.00	193.00	900
<b>Lids</b>					
75SFL	7.5" APET Square Flat Lid	7 11/16	50.00	279.00	4,800
75SFLTRED	7.5" APET Square Flat Translucent Red Lid	7 11/16	50.00	279.00	4,800

### APET Tamper-Resistant™ Packaging – Bulk & Combo

Product Number	Description	Outside Dimensions (in inches)	Case Cube	Case Weight	Case Pack
<b>4" Round GRAB &amp; GO™ DIP-N-GO™ Cups</b>					
4H10JDPLTE	10 oz. Clear Hinged Tamper-Resistant Cup w/Juice Trap, Dip Cup Lid (Leak Resistant)	4 2/7 x 4	2.50	18.00	300
4H10JILTE	10 oz. Clear Hinged Tamper-Resistant Cup w/Juice Trap, Flat Inside Lid Fit (Leak Resistant)	4 2/7 x 4	2.50	18.00	300
<b>5" x 7" Rectangular Lid &amp; Bowl</b>					
5X7ILTE	Rectangular Flat Inside Lid (Leak Resistant)	6 2/3 x 4 4/5 x 1/2	2.40	18.00	600
5X714PJTE	14 oz. Rectangular Smooth Clear Tamper-Resistant Bowl w/Juice Trap	7 1/8 x 5 2/8 x 2	2.60	16.00	400
<b>7.5" Round Tub &amp; Lid Combo</b>					
7564LRLTE	64 oz. Clear Tamper-Resistant Tub w/Leak Resistant Lid	7 5/8 x 4 3/7	2.60	14.00	105 Combo

**8" APET Square & Rectangular Bowls – Bulk & Combo**

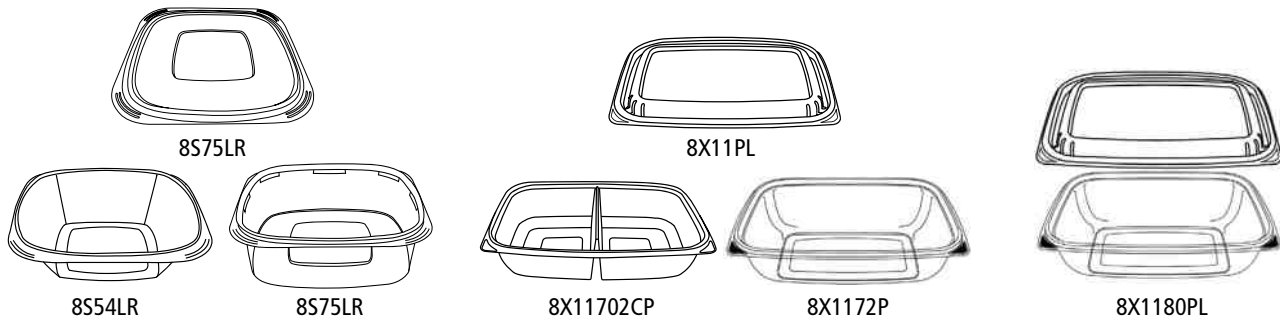

**10" APET Produce Compartmented Platters – Combo**

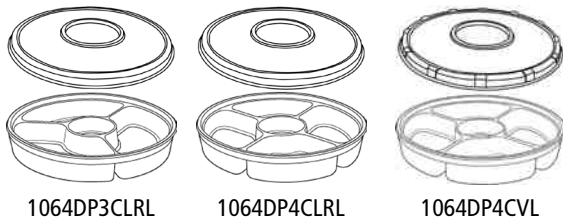

**13" APET Produce Compartmented Platters – Bulk**

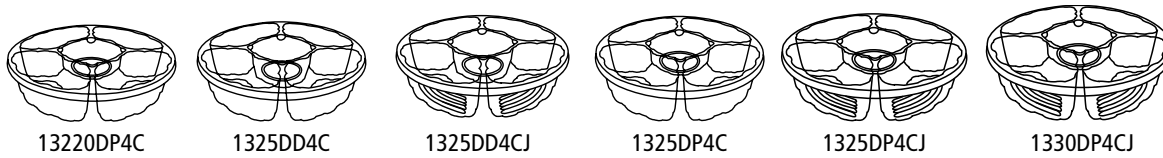

**6" APET Produce Compartmented Platters – Bulk**

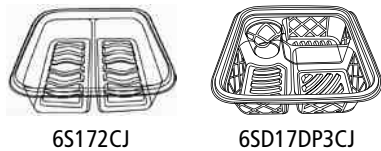

**APET Produce Compartmented Platters – Bulk**

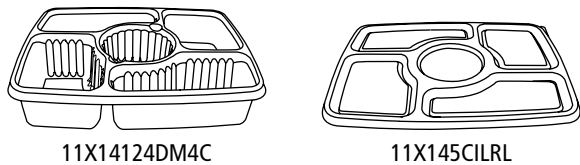

### 8" APET Square & Rectangular Bowls – Bulk & Combo

Product Number	Description	Outside Dimensions (in inches)	Case Cube	Case Weight	Case Pack
<b>8" Square Lid &amp; Bowls</b>					
8S54LR	54 oz. Square Clear Bowl (Leak Resistant)	8 5/8 x 8 5/8 x 2 5/8	3.00	18.00	200
8S75LR	75 oz. Square Clear Bowl (Leak Resistant)	8 5/8 x 8 5/8 x 2 5/8	3.00	21.00	200
8SIL	8" Square Flat Inside Lid (Leak Resistant)	8 3/4	3.00	13.00	200
<b>8" Rectangular Lids &amp; Bowls</b>					
8X11702CP	70 oz. Rectangular Clear Bowl w/ 2 Cells	11 x 7 1/2 x 2 3/4	1.80	12.00	100
8X1172P	72 oz. Rectangular Clear Bowl	11 x 7 1/2 x 2 3/4	1.80	12.00	100
8X11PL	Dome Lid (Leak Resistant)	11 x 7 1/2 x 3/4	1.80	8.00	100
<b>8" Rectangular Lid &amp; Bowl Combo</b>					
8X11802PPL	80 oz. Rectangular Clear Bowl w/ Dome Lid (Leak Resistant)	11 x 7 1/2 x 3	1.80	8.00	50 Combo

### 10" APET Produce Compartmented Platters – Combo

Product Number	Description	Outside Dimensions (in inches)	Case Cube	Case Weight	Case Pack
1064DP3CLRL	64 oz. Clear 3-Cell Platter w/Dip Cup (Leak Resistant Lid)	9 3/4 x 2 3/8	4.50	20.00	100 Combo
1064DP4CLRL	64 oz. Clear 4-Cell Platter w/Dip Cup (Leak Resistant Lid)	9 3/4 x 2 3/8	4.50	20.00	100 Combo
1064DP4CVL	64 oz. Clear 4-Cell Platter w/Dip Cup (Vented Lid)	9 3/4 x 2 3/8	4.50	20.00	100 Combo

### 13" APET Produce Compartmented Platters – Bulk

Product Number	Description	Outside Dimensions (in inches)	Case Cube	Case Weight	Case Pack
13220DP4C	13" Clear 4-Cell Platter w/8 oz. Dip Cup (Leak Resistant)	12 4/7 x 2 1/5	4.20	23.00	100
1325DD4C	13" Clear 4-Cell Platter w/12 oz. Dip Cup (Leak Resistant)	12 4/7 x 2 1/2	4.20	26.00	100
1325DD4CJ	13" Clear 4-Cell Platter w/12 oz. Dip Cup w/Juice Trap (Leak Resistant)	12 4/7 x 2 1/2	4.20	26.00	100
1325DP4C	13" Clear 4-Cell Platter w/8 oz. Dip Cup (Leak Resistant)	12 4/7 x 2 1/2	4.20	26.00	100
1325DP4CJ	13" Clear 4-Cell Platter w/8 oz. Dip Cup w/Juice Trap (Leak Resistant)	12 4/7 x 2 1/2	4.20	26.00	100
1330DP4CJ	13" Clear 4-Cell Platter w/8 oz. Dip Cup w/Juice Trap (Leak Resistant)	12 4/7 x 2 1/2	4.20	26.00	100
<b>Lids</b>					
135CLID	13" Platter Lid (Leak Resistant)	13	3.60	12.00	100
13VL	13" Vented Lid	13	3.60	12.00	100

### 6" APET Produce Compartmented Platters – Bulk

Product Number	Description	Outside Dimensions (in inches)	Case Cube	Case Weight	Case Pack
6S172CJ	17 oz. Square Clear 2-Cell Container w/ Juice Trap	6 1/8 x 6 1/8 x 1 5/6	4.60	14.00	300
6SD17DP3CJ	17 oz. Square Clear Diamond 3-Cell Container w/ Dip Cup w/ Juice Trap	6 1/8 x 6 1/8 x 1 5/6	4.20	19.00	400



### APET Produce Compartmented Platters – Bulk

Product Number	Description	Outside Dimensions (in inches)	Case Cube	Case Weight	Case Pack
11X14124DM4C	124 oz. Clear 4-Cell Platter w/ Medium Dip Cup	14 1/4 x 11 x 3	2.30	20.00	75
11X145CILRL	Individual Cell, Leak Resistant Lid	14 1/4 x 11	2.30	12.00	75

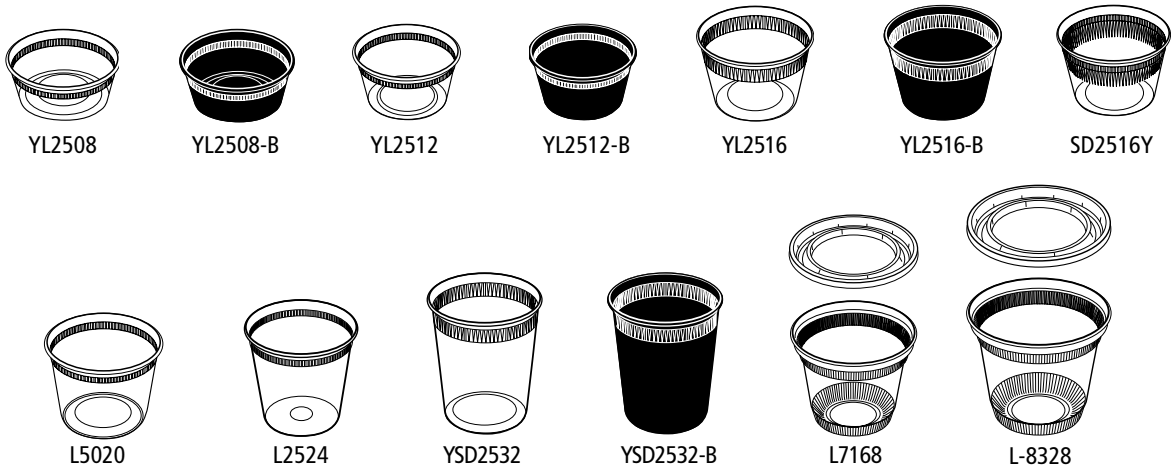
## Newspring DELtainer® Microwaveable Deli Containers



### Newspring Deli Lid Printing Matrix

Item #	Description	Minimums		
		Cases	Pieces	
YNL500		Deli Recessed Lid Bulk 480	225	108,000
			150	72,000
FL500Y		Deli Recessed Lid Bulk 480	100	48,000
			75	36,000
TL500Y		Deli Tamper Evident Lid Bulk 480	50	24,000
			25	12,000

Lead Time - 1st order 6 weeks / subsequent orders - 2 weeks.

All orders to be combined with other items to make full truckload delivery.

RMC orders will be transferred to the RMC upon completion of the print job.

## Newspring DELtainer® Microwaveable Tubs

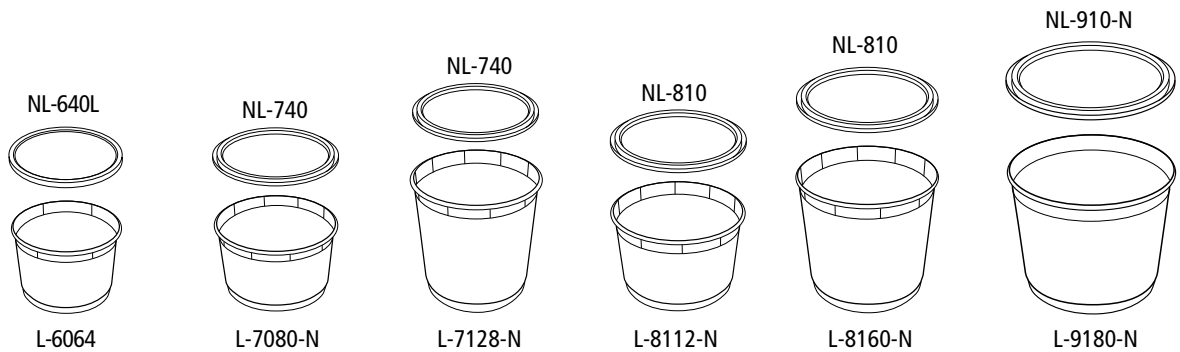

## Newspring TETainer® Tamper Evident Container

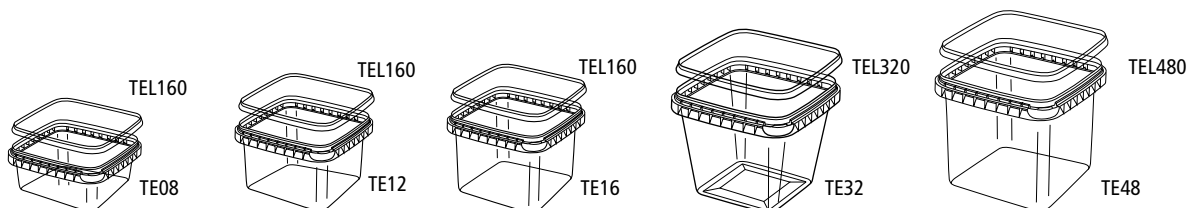

## Newspring DELtainer® Microwaveable Deli Containers

Product #	Description	Dimensions	Case Pack	Case Cube	Case Weight (lbs.)	Pallet Count
YL2508	8 oz. clear deli combo pack	4.55" dia x 1.8"	240 ea.	2.36	14.54	32
YL2508-B	8 oz. black deli combo pack	4.55" dia x 1.8"	240 ea.	2.36	14.54	32
L5008Y	8 oz. clear deli bulk pack	4.55" dia x 1.8"	480	2.10	15.84	40
YL2512	12 oz. clear deli combo pack	4.55" dia x 2.45"	240 ea.	2.15	17.02	32
YL2512-B	12 oz. black deli combo pack	4.55" dia x 2.45"	240 ea.	2.15	17.02	32
L5012Y	12 oz. clear deli bulk pack	4.55" dia x 2.45"	480	2.14	20.42	32
YSD2516	16 oz. clear deli combo pack	4.55" dia x 3.05"	240 ea.	2.15	18.68	32
SD5016Y	16 oz. clear deli bulk pack	4.55" dia x 3.05"	480	2.18	24.08	32
YL2520	20 oz. clear deli combo pack	4.55" dia x 3.45"	240 ea.	2.46	19.66	32
L5020Y	20 oz. clear deli bulk pack	4.55" dia x 3.45"	480	2.70	26.47	32
YL2524	24 oz. clear deli combo pack	4.55" dia x 4.35"	240 ea.	2.47	21.80	32
L5024Y	24 oz. clear deli bulk pack	4.55" dia x 4.35"	480	2.47	30.72	32
YSD2532	32 oz. clear deli combo pack	4.55" dia x 5.55"	240 ea.	4.23	30.53	15
YSD2532-B	32 oz. black deli combo pack	4.55" dia x 5.55"	240 ea.	4.23	30.53	15
SD5032Y	32 oz. clear deli bulk pack	4.55" dia x 5.55"	480	5.95	47.14	12
YNL500	Recessed Lid fits 8, 12, L-16, SD-16, 20, 24, 32 oz.	4.55" dia x .40"	480	2.42	13.29	32
FL500Y	Overcap Lid fits 8, 12, L-16, SD-16, 20, 24, 32 oz.	4.55" dia x .345"	480	1.80	10.00	32
TL500Y	Overcap Lid fits 8, 12, L-16, SD-16, 20, 24, 32 oz.	4.55" dia x .345"	480	3.95	20.00	16

### Squat DELtainer Packaging

L-7168	16 oz. clear squat combo pack	4.55" dia x 3.9"	200 ea.	2.39	18.85	30
L-8328	32 oz. clear squat combo pack	5.5" dia x 4.9"	200 ea.	4.09	30.59	16

\*Products are available in white by special order only.

For custom printed Deli Lids, please contact your Pactiv Sales Representative.

## Newspring DELtainer® Microwaveable Tubs

Product #	Description	Dimensions	Case Pack	Case Cube	Case Weight (lbs.)	Pallet Count
L-6064	64 oz. clear deli bulk pack	6.35" dia x 3.65"	200	4.43	22.26	18
NL-640L	Lid fits 48 oz. & 64 oz. tubs	6.45" dia x 0.45"	200	1.78	9.45	30
L-7080-N	80 oz. natural deli tub	7.43" dia x 4.45"	120	3.47	18.24	10
L-7128-N	128 oz. natural deli tub	7.43" dia x 7.5"	120	4.63	27.93	10
NL-740	Lid fits 80, 96, 112 & 128 oz. tubs	7.45" dia x 0.55"	120	1.40	8.85	25
L-8128-N	128 oz. squat natural deli tub	8.20" dia x 6.00"	90	4.13	21.48	10
L-8160-N	160 oz. natural deli tub	8.20" dia x 7.625"	90	4.83	29.69	10
NL-810-N	Lid fits 112, 128, 144 & 160 oz. tubs	8.20" dia x 0.55"	90	1.22	7.73	30

Deli tub containers are available in white and black by special order only.

## Newspring Ttainer® Tamper Evident Containers

Product #	Description	Dimensions	Cs Pack	Cs Cube	Cs Wt (lbs.)	Pallet Count	Ti/Hi
TE08	8 oz. Tamper Evident Natural Container - Bulk	4.2" x 4.2" x 1.5"	210	1.58	9.96	30	15/2
TE12	12 oz. Tamper Evident Natural Container - Bulk	4.2" x 4.2" x 2.4"	420	3.29	20.54	16	8/2
TE16	16 oz. Tamper Evident Natural Container - Bulk	4.2" x 4.2" x 3.0"	420	3.36	22.83	16	8/2
TE32	32 oz. Tamper Evident Natural Container - Bulk	5.125" x 5.125" x 3.875"	210	2.13	16.01	20	10/2
TE48	48 oz. Tamper Evident Natural Container - Bulk	5.375" x 5.375" x 4.5"	240	3.53	23.80	12	6/2
TEL160	8, 12, 16 oz. Tamper Evident Lid - Bulk	4.1" x 4.1" x .325"	840	1.87	16.72	24	8/3
TEL320	32 oz. Tamper Evident Lid - Bulk	5.0" x 5.0" x .325"	420	1.16	10.92	40	10/4
TEL480	48 oz. Tamper Evident Lid - Bulk	5.375" x 5.375" x .325"	480	1.80	15.10	24	12/2





---

# Tableware Products

---





Product Number	Description	Page
OC1800040000	CLEAR DOME FOR 4 OZ./5 OZ. BOWLS.....	H3, H5
OC1800100000	CLEAR DOME FOR 10 1/4" PLATES.....	H3, H5
OTH106010000	WHITE 6-COMPARTMENT SCHOOL LUNCH TRAY.....	H7
OTKB0010000Y	BLACK 10 1/4" DINNER PLATE.....	H5
OTKB0030000Y	BLACK 28 OZ. BOWL.....	H5
OTKB0044000Y	BLACK 10 1/4" 3-CMPT. PLATE.....	H5
10S	WHITE CARRY TRAY.....	H5
10S BLACK	BLACK CARRY TRAY.....	H5
1216	WHITE CARRY TRAY.....	H5
12S	WHITE CARRY TRAY.....	H5
12S BLACK	BLACK CARRY TRAY.....	H5
17S	WHITE CARRY TRAY.....	H5
17S BLACK	BLACK CARRY TRAY.....	H5
1S	WHITE SNACK TRAY.....	H5
1S BLACK	BLACK SNACK TRAY.....	H5
2014	WHITE CARRY TRAY.....	H5
20S	WHITE CARRY TRAY.....	H5
2S	WHITE SNACK TRAY.....	H5
2S BLACK	BLACK SNACK TRAY.....	H5
4S	WHITE SNACK TRAY.....	H5
4S BLACK	BLACK SNACK TRAY.....	H5
859100000000	PLACESSETTER® OVAL PLATTER DOME LID (PREMIER).....	H5, H7
859140000000	PLACESSETTER® PLATTER DOME LID (PREMIER).....	H5, H7
Y85975000000	PLACESSETTER® CASSEROLE DOME LID (PREMIER).....	H3, H5
85	WHITE SNACK TRAY.....	H5
8S BLACK	BLACK SNACK TRAY.....	H5
BTH1-1216	BOXED 1216.....	H5
E1001	1 OZ NEWSPRING® ELLIPSO® PORTION CUP CLEAR BASE.....	H11
E1001-B	1 OZ NEWSPRING® ELLIPSO® PORTION CUP BLACK BASE.....	H11
E1001-LD	NEWSPRING® ELLIPSO® PORTION CUP CLEAR LID FOR 1 OZ BASE.....	H11
E1002	2 OZ NEWSPRING® ELLIPSO® PORTION CUP CLEAR BASE.....	H11
E1002-B	2 OZ NEWSPRING® ELLIPSO® PORTION CUP BLACK BASE.....	H11
E1002-LD	NEWSPRING® ELLIPSO® PORTION CUP CLEAR LID FOR 2 OZ BASE.....	H11
E1003	3 OZ NEWSPRING® ELLIPSO® PORTION CUP CLEAR BASE.....	H11
E1003-B	3 OZ NEWSPRING® ELLIPSO® PORTION CUP BLACK BASE.....	H11
E1004	4 OZ NEWSPRING® ELLIPSO® PORTION CUP CLEAR BASE.....	H11
E1004-B	4 OZ NEWSPRING® ELLIPSO® PORTION CUP BLACK BASE.....	H11
E1005	5 OZ NEWSPRING® ELLIPSO® PORTION CUP CLEAR BASE.....	H11
E1005-B	5 OZ NEWSPRING® ELLIPSO® PORTION CUP BLACK BASE.....	H11
E1006	6 OZ NEWSPRING® ELLIPSO® PORTION CUP CLEAR BASE.....	H11
E1006-B	6 OZ NEWSPRING® ELLIPSO® PORTION CUP BLACK BASE.....	H11
E1034-LD	NEWSPRING® ELLIPSO® PORTION CUP CLEAR LID FOR 3 & 4 OZ BASES.....	H11
E1056-LD	NEWSPRING® ELLIPSO® PORTION CUP CLEAR LID FOR 5 & 6 OZ BASES.....	H11
E501-B	1 OZ NEWSPRING® ELLIPSO® PORTION CUP BLACK BASE & LID.....	H11
E502-B	2 OZ NEWSPRING® ELLIPSO® PORTION CUP BLACK BASE & LID.....	H11
E503	3 OZ NEWSPRING® ELLIPSO® PORTION CUP CLEAR BASE & LID.....	H11
E503-B	3 OZ NEWSPRING® ELLIPSO® PORTION CUP BLACK BASE & LID.....	H11
E504	4 OZ NEWSPRING® ELLIPSO® PORTION CUP CLEAR BASE & LID.....	H11
E504-B	4 OZ NEWSPRING® ELLIPSO® PORTION CUP BLACK BASE & LID.....	H11
E505	5 OZ NEWSPRING® ELLIPSO® PORTION CUP CLEAR BASE & LID.....	H11
E505-B	5 OZ NEWSPRING® ELLIPSO® PORTION CUP BLACK BASE & LID.....	H11
E506	6 OZ NEWSPRING® ELLIPSO® PORTION CUP CLEAR BASE & LID.....	H11
E506-B	6 OZ NEWSPRING® ELLIPSO® PORTION CUP BLACK BASE & LID.....	H11
FK-FKSSW-NSP	FIELDWARE® WHITE FORK, KNIFE, SOUP SPOON, NAPKIN, SALT, PEPPER KIT.....	H21
FK-FKW-N	FIELDWARE® WHITE FORK, KNIFE, NAPKIN KIT.....	H21
FK-FKW-NSP	FIELDWARE® WHITE FORK, KNIFE, NAPKIN, SALT, PEPPER KIT.....	H21
FK-FKSSW	FIELDWARE® WHITE FORK, SPOON, KNIFE, SOUP SPOON KIT.....	H21
FK-FSKW-5	FIELDWARE® WHITE FORK, SPOON, KNIFE KIT.....	H21
FK-FSKW-N	FIELDWARE® WHITE FORK, SPOON, KNIFE, NAPKIN KIT.....	H21
FK-FSKW-N57	FIELDWARE® WHITE FORK, KNIFE, NAPKIN, 5.75" WHITE MILK KIT.....	H21
FK-FSKW-NSP	FIELDWARE® WHITE FORK, SPOON, KNIFE, NAPKIN (13 X 12), SALT, PEPPER KIT.....	H21
FK-FSW-N57	FIELDWARE® WHITE FORK, SPOON, NAPKIN (13 X 12), 5.75" WHITE MILK KIT.....	H21
FK-FW-N	FIELDWARE® WHITE FORK, NAPKIN (10 X 10) KIT.....	H21
FK-FW-N57	FIELDWARE® WHITE FORK, NAPKIN (10 X 8), 5.75" WHITE MILK KIT.....	H21
FK-KW-N	FIELDWARE® WHITE KNIFE, NAPKIN (10 X 10) KIT.....	H21
FK-QW-N	FIELDWARE® WHITE SPOON, NAPKIN (10 X 10) KIT.....	H21
FK-QW-SCHL	FIELDWARE® WHITE SPOON, NAPKIN (10 X 8), 5.75" WHITE MILK KIT.....	H21
FK-QW-SCHL2	FIELDWARE® WHITE SPOON, NAPKIN (10 X 8), SPIKE STRAW KIT.....	H21
FK-SW-N	FIELDWARE® WHITE SPOON, NAPKIN (10 X 10) KIT.....	H21
FK-SW-SCHL	FIELDWARE® WHITE SPOON, NAPKIN (10 X 8), 5.75" WHITE MILK KIT.....	H21
FK-FW	FIELDWARE® WHITE FORK - SINGLE PIECE WRAPPED.....	H19
FK-KW	FIELDWARE® WHITE KNIFE - SINGLE PIECE WRAPPED.....	H19
FK-QW	FIELDWARE® WHITE SPOON - SINGLE PIECE WRAPPED.....	H19
FK-SSW	FIELDWARE® WHITE SOUP SPOON - SINGLE PIECE WRAPPED.....	H19
FK-SW	FIELDWARE® WHITE SPOON - SINGLE PIECE WRAPPED.....	H19
M531418	14" X 18" NATURAL CAFETERIA TRAY.....	H7
M537503	9" X 12" NATURAL CAFETERIA TRAY.....	H7
M537534	9" X 12" TAN CAFETERIA TRAY.....	H7
M60-8000Y	5 SOPHOMORE WHITE DELUXE 5-COMPARTMENT TRAY.....	H7
M627529	6" PULPEX® PLATE.....	H7
MC500060001	BAGASSE BLEND 6" SNACK PLATE.....	H7
MC500070001	BAGASSE BLEND 6 3/4" SNACK PLATE.....	H7
MC500100002	BAGASSE BLEND 10" PLATE.....	H7
MC500120001	BAGASSE BLEND 12 OZ. BOWL.....	H7
MC500160001	BAGASSE BLEND 16 OZ. BOWL.....	H7
MC500430001	BAGASSE BLEND 7 1/2" X 10 OVAL PLATTER.....	H7
MC500440002	BAGASSE BLEND 10" 3-COMPARTMENT PLATE.....	H7
MC5-0601	6 SENIOR WHITE 6-COMPARTMENT TRAY.....	H7
MC5-7603	6 JUNIOR WHITE 5-CMPT. TRAY.....	H7
MK-F	MEADOWWARE® BEIGE FORK - SINGLE PIECE WRAPPED.....	H17
MK-FE	MEADOWWARE® BLACK FORK - SINGLE PIECE WRAPPED.....	H17
MK-FK	MEADOWWARE® BEIGE FORK, KNIFE KIT.....	H19
MK-FKC	MEADOWWARE® CLEAR FORK, KNIFE KIT.....	H19
MK-FKE	MEADOWWARE® BLACK FORK, KNIFE KIT.....	H19

Product Number	Description	Page
MK-FKE-N	MEADOWWARE® BLACK FORK, KNIFE, NAPKIN KIT.....	H19
MK-FKE-N-5	MEADOWWARE® BLACK FORK, KNIFE, NAPKIN (12.5 X 13) KIT.....	H19
MK-FK-NSP	MEADOWWARE® BLACK FORK, KNIFE, NAPKIN, SALT, PEPPER KIT.....	H19
MK-FKW	MEADOWWARE® WHITE FORK, KNIFE KIT.....	H19
MK-FSKC	MEADOWWARE® CLEAR FORK, SPOON, KNIFE KIT.....	H19
MK-FSKE	MEADOWWARE® BLACK FORK, SPOON, KNIFE KIT.....	H19
MK-FSKE-N	MEADOWWARE® BLACK FORK, SPOON, KNIFE, NAPKIN KIT.....	H19
MK-FSKE-NSP	MEADOWWARE® BLACK FORK, SPOON, KNIFE, NAPKIN, SALT, PEPPER KIT.....	H19
MK-FSKW	MEADOWWARE® WHITE FORK, SPOON, KNIFE KIT.....	H19
MK-FSKW-N	MEADOWWARE® WHITE FORK, SPOON, KNIFE, NAPKIN KIT.....	H19
MK-FSKW-NSP	MEADOWWARE® WHITE FORK, SPOON, KNIFE, NAPKIN, SALT, PEPPER KIT.....	H19
MK-FSKW-NSP-5	MEADOWWARE® WHITE FORK, SPOON, KNIFE, NAPKIN (12.5 X 13), SALT, PEPPER KIT.....	H19
MK-FW-N	MEADOWWARE® WHITE FORK, NAPKIN KIT.....	H19
MK-FW	MEADOWWARE® WHITE FORK - SINGLE PIECE WRAPPED.....	H17
MK-K	MEADOWWARE® BEIGE KNIFE - SINGLE PIECE WRAPPED.....	H17
MK-KE	MEADOWWARE® BLACK KNIFE - SINGLE PIECE WRAPPED.....	H17
MK-KW	MEADOWWARE® WHITE KNIFE - SINGLE PIECE WRAPPED.....	H17
MK-S	MEADOWWARE® BEIGE SPOON - SINGLE PIECE WRAPPED.....	H17
MK-SE	MEADOWWARE® BLACK SPOON - SINGLE PIECE WRAPPED.....	H17
MK-SSE	MEADOWWARE® BLACK SOUP SPOON - SINGLE PIECE WRAPPED.....	H17
MK-SSW	MEADOWWARE® WHITE SOUP SPOON - SINGLE PIECE WRAPPED.....	H17
MK-SW	MEADOWWARE® WHITE SPOON - SINGLE PIECE WRAPPED.....	H17
NF-1000	NEWSPRING® O'SMILE™ WHITE PLASTIC FORK.....	H11
NK-1000	NEWSPRING® O'SMILE™ WHITE PLASTIC KNIFE.....	H11
NS-1000	NEWSPRING® O'SMILE™ WHITE PLASTIC SOUP SPOON.....	H11
NT-1000	NEWSPRING® O'SMILE™ WHITE PLASTIC TEASPOON.....	H11
PIP11E	9" X 11" BLACK PRAIREWARE PLATTER.....	H-9
PK-F	PRAIREWARE® BEIGE FORK - SINGLE PIECE WRAPPED.....	H17
PK-FC	PRAIREWARE® CLEAR FORK - SINGLE PIECE WRAPPED.....	H17
PK-FE	PRAIREWARE® BLACK FORK - SINGLE PIECE WRAPPED.....	H17
PK-FK	PRAIREWARE® BEIGE FORK, KNIFE KIT.....	H19
PK-FKC	PRAIREWARE® CLEAR FORK, KNIFE KIT.....	H19
PK-FKE	PRAIREWARE® BLACK FORK, KNIFE KIT.....	H19
PK-FKE-N	PRAIREWARE® BLACK FORK, KNIFE, NAPKIN KIT.....	H19
PK-FKW	PRAIREWARE® WHITE FORK, KNIFE KIT.....	H19
PK-FKW-N	PRAIREWARE® WHITE FORK, KNIFE, NAPKIN KIT.....	H19
PK-FSK	PRAIREWARE® BEIGE FORK, SPOON, KNIFE KIT.....	H19
PK-FSKC	PRAIREWARE® CLEAR FORK, SPOON, KNIFE KIT.....	H19
PK-FSKE	PRAIREWARE® BLACK FORK, SPOON, KNIFE KIT.....	H19
PK-FSKE-N	PRAIREWARE® BLACK FORK, SPOON, KNIFE, NAPKIN KIT.....	H19
PK-FSKW	PRAIREWARE® WHITE FORK, SPOON, KNIFE KIT.....	H19
PK-FSKW-N	PRAIREWARE® WHITE FORK, SPOON, KNIFE, NAPKIN KIT.....	H19
PK-FSKW-NSP	PRAIREWARE® WHITE FORK, SPOON, KNIFE, NAPKIN, SALT, PEPPER KIT.....	H19
PK-SKE-N	PRAIREWARE® BLACK SPOON, KNIFE, NAPKIN KIT.....	H19
PK-FW	PRAIREWARE® WHITE FORK - SINGLE PIECE WRAPPED.....	H17
PK-K	PRAIREWARE® BEIGE KNIFE - SINGLE PIECE WRAPPED.....	H17
PK-KE	PRAIREWARE® BLACK KNIFE - SINGLE PIECE WRAPPED.....	H17
PK-KW	PRAIREWARE® WHITE KNIFE - SINGLE PIECE WRAPPED.....	H17
PK-S	PRAIREWARE® BEIGE SPOON - SINGLE PIECE WRAPPED.....	H17
PK-SE	PRAIREWARE® BLACK SPOON - SINGLE PIECE WRAPPED.....	H17
PK-SS	PRAIREWARE® BEIGE SOUP SPOON - SINGLE PIECE WRAPPED.....	H17
PK-SSE	PRAIREWARE® BLACK SOUP SPOON - SINGLE PIECE WRAPPED.....	H17
PK-SSW	PRAIREWARE® WHITE SOUP SPOON - SINGLE PIECE WRAPPED.....	H17
PK-SW	PRAIREWARE® WHITE SPOON - SINGLE PIECE WRAPPED.....	H17
TH1-0009	PLACESSETTER® SATIN NO. 9 DINNER PLATE.....	H3
TH1-0010	PLACESSETTER® SATIN NO. 1/4" DINNER PLATE.....	H3
TH1-0011	PLACESSETTER® SATIN NO. 9 3 COMPARTMENT PLATE.....	H3
TH1-0022	PLACESSETTER® SATIN 22 OZ. RICE BOWL.....	H3
TH1-0030	PLACESSETTER® SATIN 30 OZ. BOWL.....	H3
TH1-0034	WHITE CARRY TRAY.....	H5
TH1-0044	PLACESSETTER® SATIN NO. 1/4" 3 COMPARTMENT PLATE.....	H3
TH1-0045	PLACESSETTER® SATIN 7" X 9" ENTREE PLATTER.....	H3
TH5-0004	PLACESSETTER® SATIN VANILLA 4 OZ./5 OZ. BOWL.....	H3
TH5-0007	PLACESSETTER® SATIN VANILLA 7" SANDWICH PLATE.....	H3
TH5-0009	PLACESSETTER® SATIN VANILLA NO. 9 DINNER PLATE.....	H3
TH5-0011	PLACESSETTER® SATIN VANILLA NO. 9 3 COMPARTMENT PLATE.....	H3
TH5-0045	PLACESSETTER® SATIN VANILLA 7" X 9" ENTREE PLATTER.....	H3
TK1-0006	PLACESSETTER® DELUXE 6" BREAD & BUTTER PLATE.....	H3
TK1-0009	PLACESSETTER® DELUXE NO. 9 DINNER PLATE.....	H3
TK1-0010	PLACESSETTER® DELUXE 10 1/4" DINNER PLATE.....	H3
TK1-0011	PLACESSETTER® DELUXE NO. 9 COMPARTMENT PLATE.....	H3
TK1-0044	PLACESSETTER® DELUXE 10 1/4" COMPARTMENT PLATE.....	H3
TK1-0045	PLACESSETTER® DELUXE 7" X 9" ENTREE PLATTER.....	H3
TK1-0136	WHITE LAMINATED SERVING TRAY.....	H5
TK5-0006	PLACESSETTER® DELUXE VANILLA 6" BREAD & BUTTER PLATE.....	H3
TK5-0007	PLACESSETTER® DELUXE VANILLA 7" SANDWICH PLATE.....	H3
TK5-0009	PLACESSETTER® DELUXE VANILLA NO. 9 DINNER PLATE.....	H3
TK5-0010	PLACESSETTER® DELUXE VANILLA 10 1/4" DINNER PLATE.....	H3
TK5-0011	PLACESSETTER® DELUXE VANILLA NO. 9 COMPARTMENT PLATE.....	H3
TK5-0030	PLACESSETTER® DELUXE VANILLA 30 OZ. BOWL.....	H3
TK5-0043	PLACESSETTER® DELUXE VANILLA 8 1/2" X 11 1/2" OVAL PLATTER.....	H3
TK5-0044	PLACESSETTER® DELUXE VANILLA 10 1/4" COMPARTMENT PLATE.....	H3
TKB010D0000Y	BLACK 10 1/4" DINNER PLATE.....	H5
TKB044D0000Y	BLACK 10 1/4" 3-CMPT. PLATE - DEEP.....	H5
YCI800060000	CLEAR DOME FOR 6" PLATES.....	H3, H5, H7
YCI800090000	CLEAR DOME FOR NO. 9 PLATES.....	H3, H7
YCI800120000	CLEAR DOME FOR 12 OZ. & 22 OZ. BOWLS.....	H3, H5
YCI800280000	CLEAR DOME FOR 28 OZ. BLACK BOWL.....	H5
YCI800300000	CLEAR DOME FOR 30 OZ. BOWLS.....	H3, H5
YCI800450000	CLEAR DOME FOR ENTREE PLATTERS.....	H3, H5
YE501	1 OZ NEWSPRING® ELLIPSO® PORTION CUP CLEAR BASE & LID.....	H11
YE502	2 OZ NEWSPRING® ELLIPSO® PORTION CUP CLEAR BASE & LID.....	H11
YFW-F	FIELDWARE® BEIGE FORK - POLYPROPYLENE MEDIUMWEIGHT.....	H15
YFW-FE	FIELDWARE® BLACK FORK - POLYPROPYLENE MEDIUMWEIGHT.....	H15

Product Number	Description	Page
YFW-FW	FIELDWARE® WHITE FORK - POLYPROPYLENE MEDIUMWEIGHT .....	H15
YFW-K	FIELDWARE® BEIGE KNIFE - POLYPROPYLENE MEDIUMWEIGHT .....	H15
YFW-KE	FIELDWARE® BLACK KNIFE - POLYPROPYLENE MEDIUMWEIGHT .....	H15
YFW-KW	FIELDWARE® WHITE KNIFE - POLYPROPYLENE MEDIUMWEIGHT .....	H15
YFW-PW	FIELDWARE® WHITE PARFAIT SPOON - POLYPROPYLENE MEDIUMWEIGHT .....	H15
YFW-QW	FIELDWARE® WHITE SPORK - POLYPROPYLENE MEDIUMWEIGHT .....	H15
YFW-S	FIELDWARE® BEIGE SPOON - POLYPROPYLENE MEDIUMWEIGHT .....	H15
YFW-SE	FIELDWARE® BLACK SPOON - POLYPROPYLENE MEDIUMWEIGHT .....	H15
YFW-SS	FIELDWARE® BEIGE SOUP SPOON - POLYPROPYLENE MEDIUMWEIGHT .....	H15
YFW-SSE	FIELDWARE® BLACK SOUP SPOON - POLYPROPYLENE MEDIUMWEIGHT .....	H15
YFW-SSW	FIELDWARE® WHITE SOUP SPOON - POLYPROPYLENE MEDIUMWEIGHT .....	H15
YFW-SW	FIELDWARE® WHITE SPOON - POLYPROPYLENE MEDIUMWEIGHT .....	H15
YLS-1FR	CLEAR SOUFFLE CUP LID FOR S075, S100 .....	H9
YLS-2FR	CLEAR SOUFFLE CUP LID FOR S150, S200, S250 .....	H9
YLS-3FR	CLEAR SOUFFLE CUP LID FOR S325, S400 .....	H9
YLS5FR	CLEAR SOUFFLE CUP LID FOR S550 .....	H9
YM627510	8" PULPEX® PLATE .....	H7
YM627513	9" PULPEX® PLATE .....	H7
YM627515	10" PULPEX® PLATE .....	H7
YMC500090000	BAGASSE BLEND 8 3/4" PLATE .....	H7
YMC500110002	BAGASSE BLEND 8 3/4" 3-COMPARTMENT PLATE .....	H7
YMC50047	BAGASSE BLEND 9 7/8" X 12 1/2" OVAL PLATTER .....	H7
YMI10	10.25" WHITE 1-COMPARTMENT MEADOWARE® IMPACT® PLATE .....	H9
YMI10E	10.25" BLACK 1-COMPARTMENT MEADOWARE® IMPACT® BOWL .....	H9
YMI6	6" WHITE MEADOWARE® IMPACT® PLATE .....	H9
YMI6E	6" BLACK MEADOWARE® IMPACT® PLATE .....	H9
YMI7	7" WHITE MEADOWARE® IMPACT® PLATE .....	H9
YMI7E	7" BLACK MEADOWARE® IMPACT® PLATE .....	H9
YMI9	9" WHITE 1-COMPARTMENT MEADOWARE® IMPACT® PLATE .....	H9
YMI9E	9" BLACK 1-COMPARTMENT MEADOWARE® IMPACT® BOWL .....	H9
YMI12	12 OZ WHITE MEADOWARE® IMPACT® BOWL .....	H9
YMI12E	12 OZ BLACK MEADOWARE® IMPACT® BOWL .....	H9
YMI15	5 OZ WHITE MEADOWARE® IMPACT® BOWL .....	H9
YMI15E	5 OZ BLACK MEADOWARE® IMPACT® BOWL .....	H9
YMI10C	10.25" WHITE 3-COMPARTMENT MEADOWARE® IMPACT® PLATE .....	H9
YMI10E	10.25" BLACK 3-COMPARTMENT MEADOWARE® IMPACT® BOWL .....	H9
YMI9C	9" WHITE 3-COMPARTMENT MEADOWARE® IMPACT® PLATE .....	H9
YMI9E	9" BLACK 3-COMPARTMENT MEADOWARE® IMPACT® BOWL .....	H9
YMW	MEADOWARE® BEIGE FORK - POLYSTYRENE HEAVYWEIGHT MID-LENGTH .....	H13
YMWFC	MEADOWARE® CLEAR FORK - POLYSTYRENE HEAVYWEIGHT MID-LENGTH .....	H13
YMWFE	MEADOWARE® BLACK FORK - POLYSTYRENE HEAVYWEIGHT MID-LENGTH .....	H13
YMWFW	MEADOWARE® WHITE FORK - POLYSTYRENE HEAVYWEIGHT MID-LENGTH .....	H13
YMWK	MEADOWARE® BEIGE KNIFE - POLYSTYRENE HEAVYWEIGHT MID-LENGTH .....	H13
YMWKC	MEADOWARE® CLEAR KNIFE - POLYSTYRENE HEAVYWEIGHT MID-LENGTH .....	H13
YMWKE	MEADOWARE® BLACK KNIFE - POLYSTYRENE HEAVYWEIGHT MID-LENGTH .....	H13
YMWKW	MEADOWARE® WHITE KNIFE - POLYSTYRENE HEAVYWEIGHT MID-LENGTH .....	H13
YMWK	MEADOWARE® BEIGE SPOON - POLYSTYRENE HEAVYWEIGHT MID-LENGTH .....	H13
YMWSC	MEADOWARE® CLEAR SPOON - POLYSTYRENE HEAVYWEIGHT MID-LENGTH .....	H13
YMWSE	MEADOWARE® BLACK SPOON - POLYSTYRENE HEAVYWEIGHT MID-LENGTH .....	H13
YMWSS	MEADOWARE® BEIGE SOUP SPOON - POLYSTYRENE HEAVYWEIGHT MID-LENGTH .....	H13
YMWSSC	MEADOWARE® CLEAR SOUP SPOON - POLYSTYRENE HEAVYWEIGHT MID-LENGTH .....	H13
YMWSSSE	MEADOWARE® BLACK SOUP SPOON - POLYSTYRENE HEAVYWEIGHT MID-LENGTH .....	H13
YMWSSW	MEADOWARE® WHITE SOUP SPOON - POLYSTYRENE HEAVYWEIGHT MID-LENGTH .....	H13
YMWSS	MEADOWARE® WHITE SPOON - POLYSTYRENE HEAVYWEIGHT MID-LENGTH .....	H13
YMWFCB	MEADOWARE® CLEAR FORK - POLYSTYRENE HVYWT MID-LENGTH - BOXED .....	H17
YMWFCB	MEADOWARE® BLACK FORK - POLYSTYRENE HVYWT MID-LENGTH - BOXED .....	H17
YMWFCB	MEADOWARE® WHITE FORK - POLYSTYRENE HVYWT MID-LENGTH - BOXED .....	H17
YMWFCB	MEADOWARE® CLEAR KNIFE - POLYSTYRENE HVYWT MID-LENGTH - BOXED .....	H17
YMWFCB	MEADOWARE® BLACK KNIFE - POLYSTYRENE HVYWT MID-LENGTH - BOXED .....	H17
YMWFCB	MEADOWARE® WHITE KNIFE - POLYSTYRENE HVYWT MID-LENGTH - BOXED .....	H17
YMWFCB	MEADOWARE® CLEAR SPOON - POLYSTYRENE HVYWT MID-LENGTH - BOXED .....	H17
YMWFCB	MEADOWARE® WHITE SPOON - POLYSTYRENE HVYWT MID-LENGTH - BOXED .....	H17
YMWFCB	MEADOWARE® BEIGE FORK POLYSTYRENE HVYWT FULL-LENGTH .....	H13
YMWFCB	PRAIRIE HOLLOW® CLEAR FORK POLYSTYRENE HVYWT FULL-LENGTH .....	H13
YMWFCB	PRAIRIE HOLLOW® BLACK FORK POLYSTYRENE HVYWT FULL-LENGTH .....	H13
YMWFCB	PRAIRIE HOLLOW® WHITE FORK POLYSTYRENE HVYWT FULL-LENGTH .....	H13
YMWFCB	PRAIRIE HOLLOW® BEIGE KNIFE POLYSTYRENE HVYWT FULL-LENGTH .....	H13
YMWFCB	PRAIRIE HOLLOW® CLEAR KNIFE POLYSTYRENE HVYWT FULL-LENGTH .....	H13
YMWFCB	PRAIRIE HOLLOW® BLACK KNIFE POLYSTYRENE HVYWT FULL-LENGTH .....	H13
YMWFCB	PRAIRIE HOLLOW® WHITE KNIFE POLYSTYRENE HVYWT FULL-LENGTH .....	H13
YMWFCB	PRAIRIE HOLLOW® BEIGE SPOON POLYSTYRENE HVYWT FULL-LENGTH .....	H13
YMWFCB	PRAIRIE HOLLOW® CLEAR SPOON POLYSTYRENE HVYWT FULL-LENGTH .....	H13
YMWFCB	PRAIRIE HOLLOW® BLACK SPOON POLYSTYRENE HVYWT FULL-LENGTH .....	H13
YMWFCB	PRAIRIE HOLLOW® WHITE SPOON POLYSTYRENE HVYWT FULL-LENGTH .....	H13
YMWFCB	6" WHITE PRAIRIEWARE® IMPACT® PLATE .....	H9
YMWFCB	6" BLACK PRAIRIEWARE® IMPACT® PLATE .....	H9
YMWFCB	7" WHITE PRAIRIEWARE® IMPACT® PLATE .....	H9
YMWFCB	7" BLACK PRAIRIEWARE® IMPACT® PLATE .....	H9
YMWFCB	9" WHITE 1-COMPARTMENT PRAIRIEWARE® IMPACT® PLATE .....	H9
YMWFCB	9" BLACK 1-COMPARTMENT PRAIRIEWARE® IMPACT® BOWL .....	H9
YMWFCB	5 OZ WHITE PRAIRIEWARE® IMPACT® BOWL .....	H9
YMWFCB	5 OZ BLACK PRAIRIEWARE® IMPACT® BOWL .....	H9
YMWFCB	5 OZ WHITE PRAIRIEWARE® IMPACT® BOWL .....	H9
YMWFCB	5 OZ BLACK PRAIRIEWARE® IMPACT® BOWL .....	H9
YMWFCB	10.25" WHITE 3-COMPARTMENT PRAIRIEWARE® IMPACT® PLATE .....	H9
YMWFCB	10.25" BLACK 3-COMPARTMENT PRAIRIEWARE® IMPACT® BOWL .....	H9
YMWFCB	9" WHITE 3-COMPARTMENT PRAIRIEWARE® IMPACT® PLATE .....	H9
YMWFCB	9" BLACK 3-COMPARTMENT PRAIRIEWARE® IMPACT® BOWL .....	H9
YMWFCB	EARTHCHOICE® PSM FULL LENGTH HEAVY FORK .....	H21
YMWFCB	EARTHCHOICE® PSM FULL LENGTH HEAVY KNIFE .....	H21
YMWFCB	EARTHCHOICE® PSM FULL LENGTH CUTLERY KIT .....	H21
YMWFCB	EARTHCHOICE® PSM FULL LENGTH HEAVY SPOON .....	H21
YMWFCB	PRAIRIEWARE® BEIGE FORK - POLYSTYRENE HEAVYWEIGHT FULL-LENGTH .....	H13

Product Number	Description	Page
YPWF-BX	PRAIRIEWARE® BEIGE FORK - POLYSTYRENE HVYWT FULL-LENGTH - BOXED .....	H15
YPWF-FC	PRAIRIEWARE® CLEAR FORK - POLYSTYRENE HEAVYWEIGHT FULL-LENGTH .....	H13
YPWF-FE	PRAIRIEWARE® BLACK FORK - POLYSTYRENE HEAVYWEIGHT FULL-LENGTH .....	H13
YPWF-FW	PRAIRIEWARE® WHITE FORK - POLYSTYRENE HEAVYWEIGHT FULL-LENGTH .....	H13
YPWF-K	PRAIRIEWARE® BEIGE KNIFE - POLYSTYRENE HEAVYWEIGHT FULL-LENGTH .....	H13
YPWF-KC	PRAIRIEWARE® CLEAR KNIFE - POLYSTYRENE HEAVYWEIGHT FULL-LENGTH .....	H13
YPWF-KE	PRAIRIEWARE® BLACK KNIFE - POLYSTYRENE HEAVYWEIGHT FULL-LENGTH .....	H13
YPWF-KW	PRAIRIEWARE® WHITE KNIFE - POLYSTYRENE HEAVYWEIGHT FULL-LENGTH .....	H13
YPWF-S	PRAIRIEWARE® BEIGE SPOON - POLYSTYRENE HEAVYWEIGHT FULL-LENGTH .....	H13
YPWF-SC	PRAIRIEWARE® CLEAR SPOON - POLYSTYRENE HEAVYWEIGHT FULL-LENGTH .....	H13
YPWF-SE	PRAIRIEWARE® BLACK SPOON - POLYSTYRENE HEAVYWEIGHT FULL-LENGTH .....	H13
YPWF-SS	PRAIRIEWARE® BEIGE SOUP SPOON - POLYSTYRENE HVYWT FULL-LENGTH .....	H13
YPWF-SSC	PRAIRIEWARE® CLEAR SOUP SPOON - POLYSTYRENE HVYWT FULL-LENGTH .....	H13
YPWF-SSE	PRAIRIEWARE® BLACK SOUP SPOON - POLYSTYRENE HVYWT FULL-LENGTH .....	H13
YPWF-SSW	PRAIRIEWARE® WHITE SOUP SPOON - POLYSTYRENE HVYWT FULL-LENGTH .....	H13
YPWWS	PRAIRIEWARE® WHITE SPOON - POLYSTYRENE HEAVYWEIGHT FULL-LENGTH .....	H13
YPWFCB	PRAIRIEWARE® CLEAR FORK - POLYSTYRENE HVYWT FULL-LENGTH - BOXED .....	H15
YPWFEB	PRAIRIEWARE® BLACK FORK - POLYSTYRENE HVYWT FULL-LENGTH - BOXED .....	H15
YPWFWB	PRAIRIEWARE® WHITE FORK - POLYSTYRENE HVYWT FULL-LENGTH - BOXED .....	H15
YPWKB	PRAIRIEWARE® BEIGE KNIFE - POLYSTYRENE HVYWT FULL-LENGTH - BOXED .....	H15
YPWKCB	PRAIRIEWARE® CLEAR KNIFE - POLYSTYRENE HVYWT FULL-LENGTH - BOXED .....	H15
YPWKCB	PRAIRIEWARE® BLACK KNIFE - POLYSTYRENE HVYWT FULL-LENGTH - BOXED .....	H15
YPWKWB	PRAIRIEWARE® WHITE KNIFE - POLYSTYRENE HVYWT FULL-LENGTH - BOXED .....	H15
YPWSB	PRAIRIEWARE® BEIGE SPOON - POLYSTYRENE HVYWT FULL-LENGTH - BOXED .....	H15
YPWSCB	PRAIRIEWARE® CLEAR SPOON - POLYSTYRENE HVYWT FULL-LENGTH - BOXED .....	H15
YPWSEB	PRAIRIEWARE® BLACK SPOON - POLYSTYRENE HVYWT FULL-LENGTH - BOXED .....	H15
YPWSSB	PRAIRIEWARE® BEIGE SOUP SPOON - POLYSTYRENE HVYWT FULL-LENGTH - BOXED .....	H15
YPWSSCB	PRAIRIEWARE® CLEAR SOUP SPOON - POLYSTYRENE HVYWT FULL-LENGTH - BOXED .....	H15
YPWSSWB	PRAIRIEWARE® BLACK SOUP SPOON - POLYSTYRENE HVYWT FULL-LENGTH - BOXED .....	H15
YPWSSWB	PRAIRIEWARE® WHITE SOUP SPOON - POLYSTYRENE HVYWT FULL-LENGTH - BOXED .....	H15
YPZ15W	NEWSPRING® O'SMILE™ WHITE PLASTIC PIZZA STAND .....	H11
YS075	.75 OZ. HIPS TRANSLUCENT PORTION CUP .....	H9
YS100	1 OZ. HIPS TRANSLUCENT PORTION CUP .....	H9
YS150	1.5 OZ. HIPS TRANSLUCENT PORTION CUP .....	H9
YS200	2 OZ. HIPS TRANSLUCENT PORTION CUP .....	H9
YS200E	2 OZ. HIPS EBONY PORTION CUP .....	H9
YS250	2.5 OZ. HIPS TRANSLUCENT PORTION CUP .....	H9
YS300	3.25 OZ. HIPS TRANSLUCENT PORTION CUP .....	H9
YS300E	3.25 OZ. HIPS EBONY PORTION CUP .....	H9
YS400	4 OZ. HIPS TRANSLUCENT PORTION CUP .....	H9
YS400E	4 OZ. HIPS EBONY PORTION CUP .....	H9
YS500	5 OZ. HIPS TRANSLUCENT PORTION CUP .....	H9
YSPP150	1.5 OZ. CLEAR POLYPROPYLENE PORTION CUP .....	H9
YSPP200	2 OZ. CLEAR POLYPROPYLENE PORTION CUP .....	H9
YSPP200E	2 OZ. EBONY POLYPROPYLENE PORTION CUP .....	H9
YSPP300	3.25 OZ. CLEAR POLYPROPYLENE PORTION CUP .....	H9
YSPP300E	3.25 OZ. EBONY POLYPROPYLENE PORTION CUP .....	H9
YSPP400	4 OZ. CLEAR POLYPROPYLENE PORTION CUP .....	H9
YSPP400E	4 OZ. EBONY POLYPROPYLENE PORTION CUP .....	H9
YTH10004	PLACESSETTER® SATIN 4 OZ./5 OZ. BOWL .....	H3
YTH10006	PLACESSETTER® SATIN 6" BREAD & BUTTER PLATE .....	H3
YTH10007	PLACESSETTER® SATIN 7" SANDWICH PLATE .....	H3
YTH10012	PLACESSETTER® SATIN 12 OZ. BOWL .....	H3
YTH10043	PLACESSETTER® SATIN 8 1/2" X 11 1/2" OVAL PLATTER .....	H3
YTH105000000	WHITE 5-COMPARTMENT SCHOOL LUNCH TRAY .....	H7
YTH50006	PLACESSETTER® SATIN VANILLA 6" BREAD & BUTTER PLATE .....	H3
YTH50012	PLACESSETTER® SATIN VANILLA 12 OZ. BOWL .....	H3
YTH50043	PLACESSETTER® SATIN VANILLA 9 1/2" X 11 1/2" OVAL PLATTER .....	H3
YTHB050000000	BLACK 5-COMPARTMENT SCHOOL LUNCH TRAY .....	H7
YTK10004	PLACESSETTER® DELUXE 4 OZ./5 OZ. BOWL .....	H3
YTK10007	PLACESSETTER® DELUXE 7" SANDWICH PLATE .....	H3
YTK10012	PLACESSETTER® DELUXE 12 OZ. BOWL .....	H3
YTK10043	PLACESSETTER® DELUXE 8 1/2" X 11 1/2" OVAL PLATTER .....	H3
YTK50004	PLACESSETTER® DELUXE VANILLA 4 OZ./5 OZ. BOWL .....	H3
YTK50012	PLACESSETTER® DELUXE VANILLA 12 OZ. BOWL .....	H3
YTK50043	PLACESSETTER® DELUXE VANILLA 7" X 9" ENTREE PLATTER .....	H3
YTK5008D	PLACESSETTER® DELUXE VANILLA 8 OZ. CASSEROLE DISH (DEEP) .....	H3
YTKB011D0000	BLACK NO.9 3-CMPT. PLATE - DEEP .....	H5
YTKB00040000	BLACK 4 OZ./5 OZ. BOWL .....	H5
YTKB00070000	BLACK 7" DINNER PLATE .....	H5
YTKB00060000	BLACK 6" BREAD & BUTTER PLATE .....	H5
YTKB00090000	BLACK NO.9 DINNER PLATE .....	H5
YTKB00110000	BLACK NO.9 3-CMPT. PLATE .....	H5
YTKB00120000	BLACK 12 OZ. BOWL .....	H5
YTKB00430000	BLACK 7 1/2" X 10 1/4" OVAL PLATTER .....	H5
YTKB00470000	BLACK 10" X 12 1/2" PLATTER .....	H5
YTKB008D0000	BLACK 8 OZ. CASSEROLE DISH (DEEP) .....	H5
YTKB009D0000	BLACK NO.9 DINNER PLATE - DEEP .....	H5
YTKB044D0000	BLACK 10 1/4" 3-CMPT PLATE - DEEP .....	H5



## Placemaker® Satin Non-Laminated Tableware

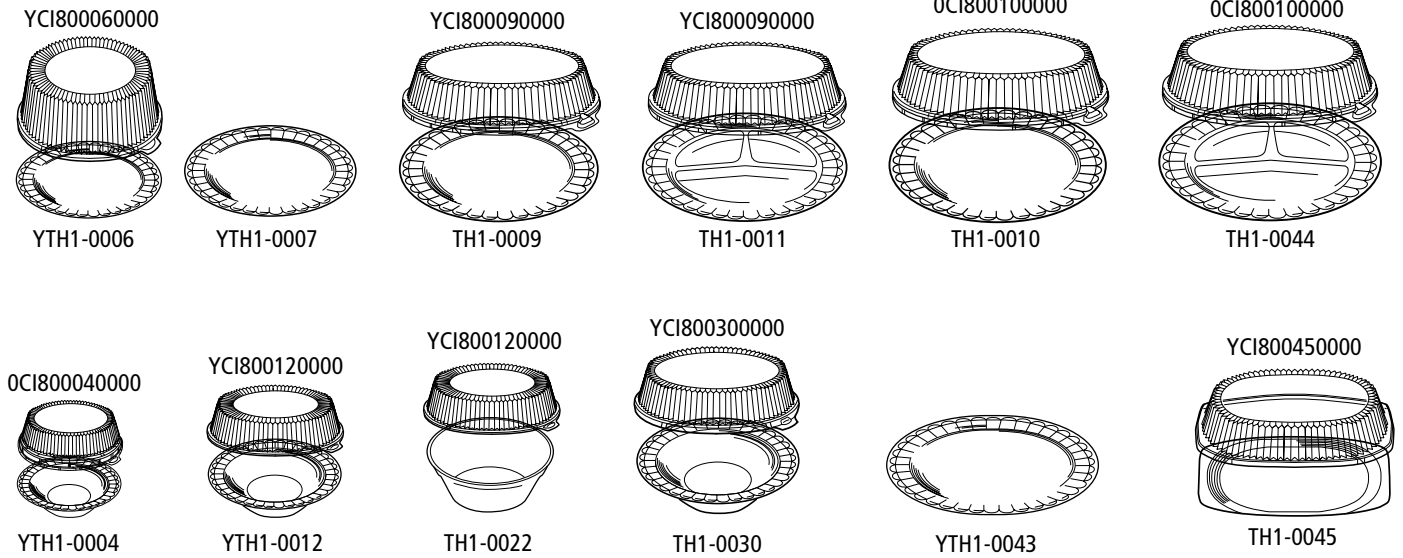

## Placemaker Deluxe Laminated Tableware

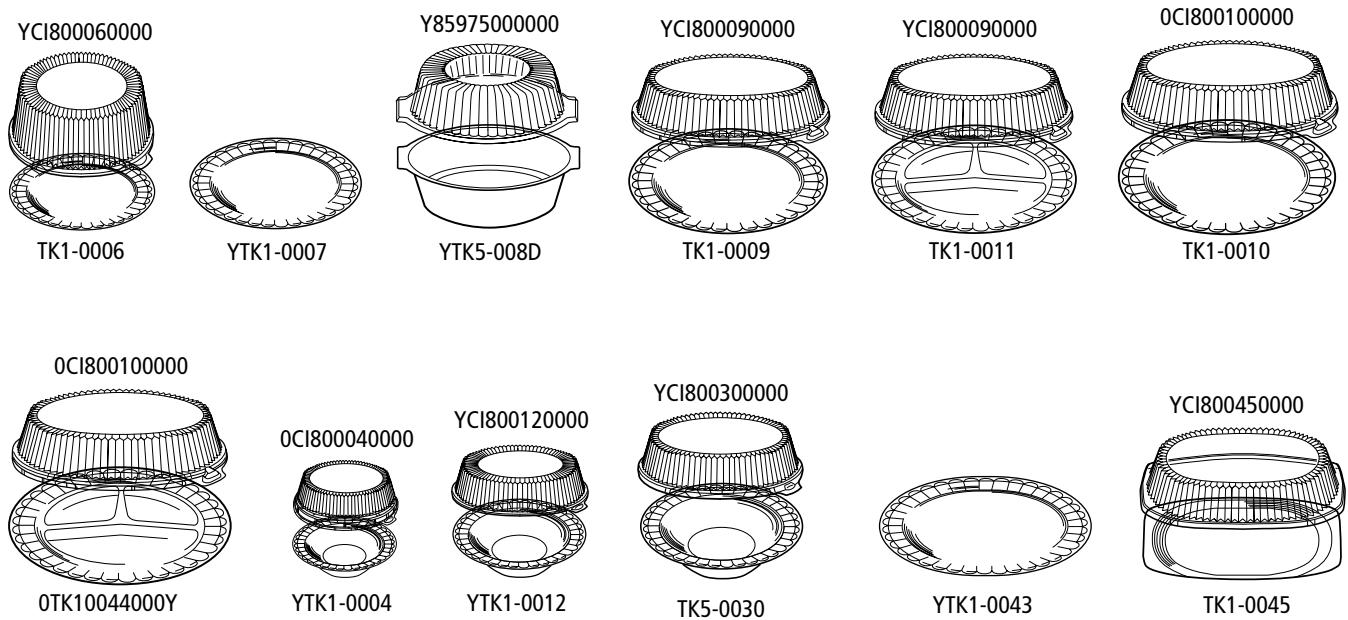

**Placemaker® Satin Non-Laminated Tableware**

Product Numbers		Description	Dimension (in inches)	Case		Packing		Cases/ Unit Load
White	Vanilla			Cube	Approx Wt.	Sleeve	Case	
YTH1-0006		6" Bread & Butter Plate	6" dia.	1.75	5.70	8/125	1000	30
	YTH5-0006	6" Bread & Butter Plate	6" dia.	1.75	5.70	8/125	1000	30
YCI800060000		Clear Dome for 6" Plates & 12 oz. Bowls	--	4.53	9.32	8/63	504	12
YTH1-0007		7" Sandwich Plate	7" dia.	2.16	7.30	6/150	900	20
	TH5-0007	7" Sandwich Plate	7" dia.	2.41	8.46	8/125	1000	15
TH1-0009		No. 9 Dinner Plate	8 7/8" dia.	2.39	7.46	4/125	500	20
	TH5-0009	No. 9 Dinner Plate	8 7/8" dia.	2.39	7.46	4/125	500	20
TH1-0011		No. 9 3-Compartment Plate	8 7/8" dia.	2.44	6.96	4/125	500	20
	TH5-0011	No. 9 3-Compartment Plate	8 7/8" dia.	2.44	6.96	4/125	500	20
YCI800090000		Clear Dome for No. 9 Plates	--	1.71	5.02	2/63	126	30
TH1-0010	N/A	10 1/4" Dinner Plate	10 1/4" dia.	2.77	10.75	4/125	500	20
TH1-0044		10 1/4" 3-Compartment Plate	10 1/4" dia.	1.98	4.40	10/125	1250	24
OCI800100000		Clear Dome for 10 1/4" Plates	--	6.16	12.16	4/63	252	8
YTH1-0004		4 oz./5 oz. Bowl	--	1.98	4.75	10/125	1250	24
	TH5-0004	4 oz./5 oz. Bowl	--	1.98	4.75	10/125	1250	24
OCI800040000		Clear Dome for 4 oz./5 oz. Bowls	--	5.10	9.03	12/84	1008	12
YTH1-0012	N/A	12 oz. Bowl	--	3.17	8.04	8/125	1000	18
	YTH5-0012	12 oz. Bowl	--	3.17	8.04	8/125	1000	18
TH1-0022*	N/A	22 oz. Rice Bowl	--	3.70	9.14	6/84	504	18
YCI800120000		Clear Dome for 12 oz. & 22 oz. Bowls	--	2.89	7.06	6/84	504	14
TH1-0030	N/A	30 oz. Bowl	--	3.55	9.02	4/125	500	18
YCI800300000*		Clear Dome for 30 oz. Bowls	8" Dia. x 1" Deep	6.32	15.81	6/84	504	8
YTH1-0043		8 1/2" x 11 1/2" Oval Platter	8 1/2 x 11 1/2	2.62	9.02	4/125	500	24
	YTH5-0043	8 1/2" x 11 1/2" Oval Platter	8 1/2 x 11 1/2	2.62	9.02	4/125	500	24
TH1-0045		7" x 9" Entree Platter	7 x 9	3.42	11.02	8/125	1000	12
	TH5-0045	7" x 9" Entree Platter	7 x 9	3.42	11.02	8/125	1000	12
YCI800450000		Clear Dome for Entree Platters	--	1.39	5.49	6/84	504	45

**Placemaker Deluxe Laminated Tableware**

Product Numbers		Description	Dimension (in inches)	Case		Packing		Cases/ Unit Load
White	Vanilla			Cube	Approx Wt.	Sleeve	Case	
TK1-0006		6" Bread & Butter Plate	6" dia.	2.08	6.03	8/125	1000	24
	TK5-0006	6" Bread & Butter Plate	6" dia.	2.08	6.90	8/125	1000	24
YCI800060000		Clear Dome for 6" Plates & 12 oz. Bowls	--	4.53	9.32	8/63	504	12
YTK1-0007		7" Sandwich Plate	7" dia.	2.34	7.30	6/150	900	20
N/A	YTK5-008D	8 oz. Casserole Dish (Deep)	--	2.03	5.50	6/84	504	30
Y85975000000		Clear Casserole Dome	--	2.49	8.46	8/63	504	
TK1-0009		No. 9 Dinner Plate	8 7/8" dia.	2.62	7.70	4/125	500	20
YTK1009D0000		No. 9 Dinner Plate (Deep)	8 7/8" dia.		9.75	4/125	500	30
	TK5-0009	No. 9 Dinner Plate	8 7/8" dia.	2.62	8.52	4/125	500	20
TK1-0011		No. 9 3-Compartment Plate	8 7/8" dia.	2.72	8.13	4/125	500	20
YTK1011D0000		No. 9 3-Compartment Plate (Deep)	8 7/8" dia.		9.75	4/125	500	30
	TK5-0011	No. 9 3-Compartment Plate (Deep)	8 7/8" dia.	2.72	8.08	4/125	500	20
YCI800090000		Clear Dome for No. 9 Plates	--	1.85	4.25	2/63	126	30
TK1-0010		10 1/4" Dinner Plate	10 1/4" dia.	3.53	11.15	4/125	500	16
	TK5-0010	10 1/4" Dinner Plate	10 1/4" dia.	3.53	11.15	4/125	500	16
OTK10044000Y		10 1/4" 3-Compartment Plate	10 1/4" dia.	3.43	12.40	4/125	500	20
OTK1044D000Y		10 1/4" 3-Compartment Plate	10 1/4" dia.					
	TK5-0044	10 1/4" 3-Compartment Plate	10 1/4" dia.	3.43	12.87	4/125	500	20
OCI800100000		Clear Dome for 10 1/4" Plates	--	6.16	12.16	4/63	252	8
YTK1-0004		4 oz./5 oz. Bowl	--	1.98	5.51	10/125	1250	24
	YTK5-0004	4 oz./5 oz. Bowl	--	1.98	5.51	10/125	1250	24
OCI800040000		Clear Dome for 4 oz./5 oz. Bowls	--	5.10	9.03	12/84	1008	12
YTK1-0012		12 oz. Bowl	--	3.24	8.87	8/125	1000	18
	YTK5-0012	12 oz. Bowl	--	3.24	8.87	8/125	1000	18
YCI800120000		Clear Dome for 12 oz. Bowls	--	2.89	7.06	6/84	504	14
N/A	TK5-0030	30 oz. Bowl	--	3.55	8.00	4/125	500	18
YCI800300000		Clear Dome Lid for 30 oz. Foam Bowls	8" Dia. x 1" Deep	6.32	15.81	6/84	504	8
YTK1-0043		8 1/2" x 11 1/2" Oval Platter	8 1/2 x 11 1/2	2.62	12.00	4/125	500	24
	YTK5-0043	8 1/2" x 11 1/2" Oval Platter	8 1/2 x 11 1/2	2.62	12.00	4/125	500	24
TK1-0045		7" x 9" Entree Platter	7 x 9	3.27	15.12	8/125	1000	12
	YTK5-0045	7" x 9" Entree Platter	7 x 9	3.27	15.12	8/125	1000	12
YCI800450000		Clear Dome for Entree Platters	--	1.39	5.49	6/84	200	45

## Placemaker® Deluxe Black Laminated Tableware

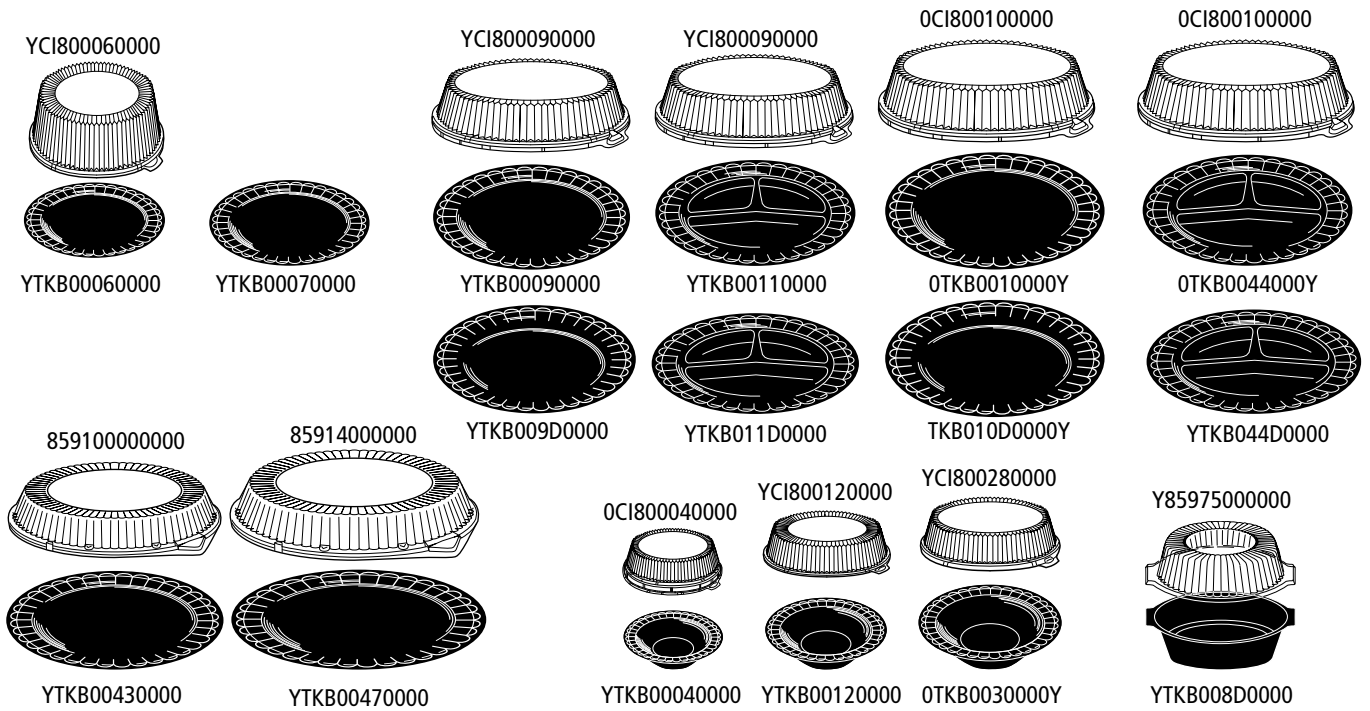

## Placemaker Domes, Lids & Covers

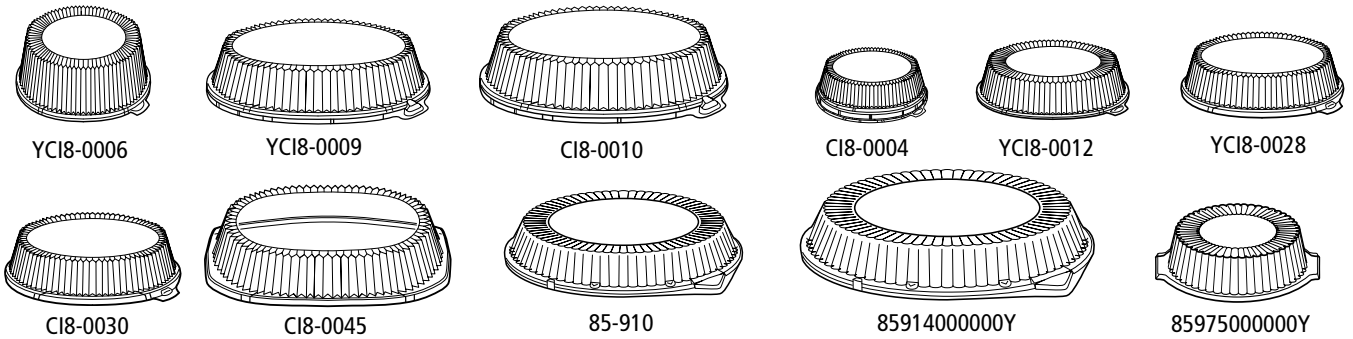

## Carrying Trays

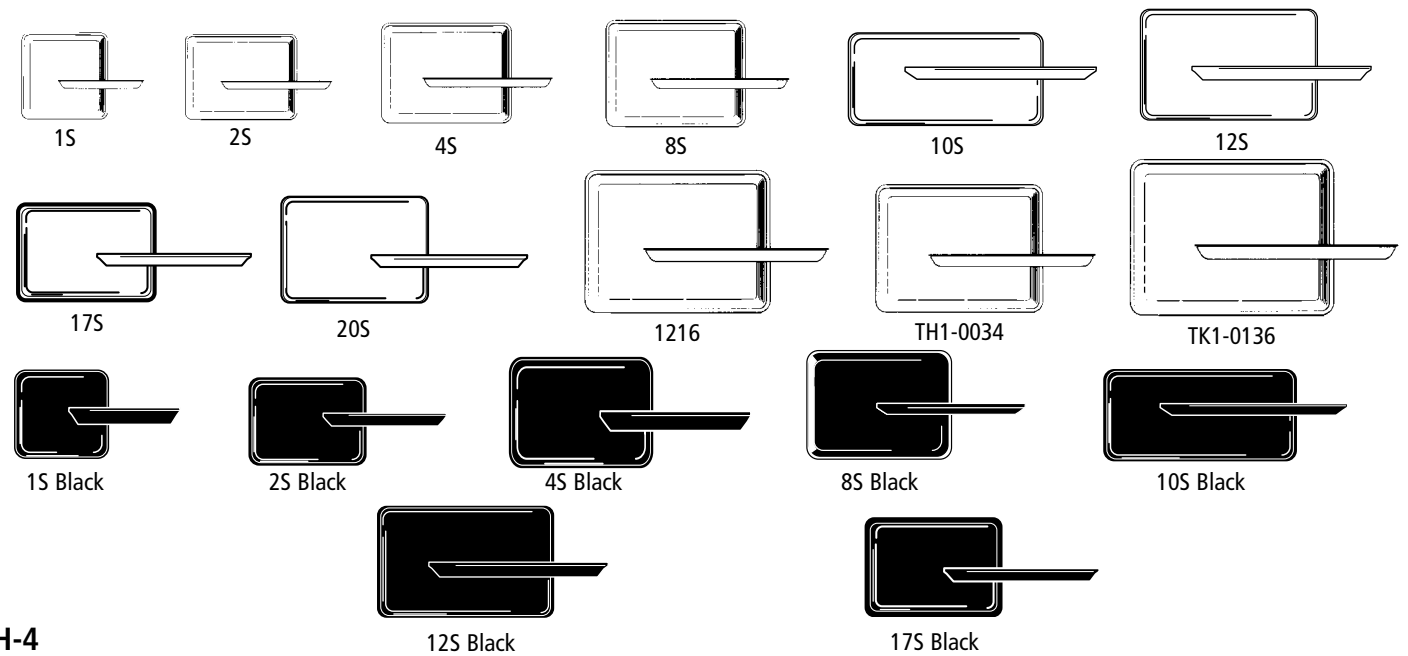

### Placemaker® Deluxe Black Laminated Tableware

Product Number	Description	Dimensions (in inches)	Cube	Case		Packing		Cases/ Unit Load
				Approx Wt.	Sleeve	Case		
YTKB00060000	Black 6" Bread & Butter Plate	6 dia.	2.42	9.36	8/125	1000	24	
YCI800060000	Clear 6" Plate Dome	--	4.53	9.32	8/63	504	12	
YTKB00070000	Black 7" Dinner Plate	7 dia.	3.15	11.32	6/150	900	15	
YTKB00090000	Black No. 9 Dinner Plate	8 7/8 dia.	2.57	10.08	4/125	500	20	
YTKB0009D0000	Black No. 9 Dinner Plate (Deep)	8 7/8 dia.						
YTKB00110000	Black No. 9 3-Compartment Plate	8 7/8 dia.	2.57	13.72	4/125	500	20	
YTKB011D0000	Black No. 9 3-Compartment Plate (Deep)	8 7/8 dia.						
YCI800090000	Clear Dome for No 9. Plate	--	1.85	4.25	2/63	126	30	
OTKB0010000Y	Black 10 1/4" Dinner Plate	10 1/4 dia.	3.42	13.34	4/125	500	16	
TKB010D0000Y	Black 10 1/4" Dinner Plate	10 1/4 dia.		17.34	4/125	500		
OTKB0044000Y	Black 10 1/4" 3-Compartment Plate	10 1/4 dia.	3.53	14.81	4/125	500	16	
TKB044D0000Y	Black 10 1/4" 3-Compartment Plate	10 1/4 dia.						
OCI800100000	Clear Dome for 10 1/4" Plate	--	6.16	12.16	4/63	252	8	
YTKB00040000	Black 4 oz./5 oz. Bowl	--	2.18	8.06	10/125	1250	24	
OCI800040000	Clear Dome for 4 oz./5 oz. Bowls	--	5.10	9.03	12/84	1008	12	
YTKB00120000	Black 12 oz. Bowl	--	3.55	11.32	8/125	1000	16	
YCI800120000	Clear Dome for 12 oz. Bowl	--	3.00	7.30	6/84	504	14	
OTKB0030000Y	Black 28 oz. Bowl	--	3.50	14.65	3/150	450	20	
YCI800280000	Clear Dome Lid for TXB-0030 - 28 oz. Bowl	8 dia. x 1.5 deep	6.32	13.39	6/84	504	18	
YTKB008D0000	Black 8 oz. Casserole Dish (Deep)	--	2.96	8.45	6/84	504	20	
85975000000Y	Clear Casserole Dome (Premier)	--	2.60	8.81	8/63	500	24	
YTKB00430000	Black 7 1/2" x 10 1/4" Oval Platter	7 1/2 x 10 1/4	3.34	19.38	4/150	600	8	
859100000000	Clear Dome for Oval Platter (Premier)	--	4.20	8.03	4/63	252	12	
YTKB00470000	Black 10" x 12 1/2" Platter	10 x 12 1/2	5.80	16.57	4/125	500	8	
85914000000Y	Clear Dome for Platter (Premier)	10 x 12 1/2	8.08	18.43	4/75	300	8	
YTKB044D0000	Black 10 1/4" Deep 3-Compartment Plate	10 1/4 dia.	4.27	13.50	4/125	500	16	

### Placemaker® Domes, Lids & Covers

Product Number	Description	Capacity (fl. oz.)	Dimension (in inches)	Cube	Case		Packing		Cases/ Unit Load
					Approx Wt.	Sleeve	Case		
YCI8-0006	Clear 6" Plate Dome	--	--	4.53	9.32	8/63	504	12	
YCI8-0009	Clear No. 9 Plate Dome	30 oz.	--	1.85	4.25	2/63	126	30	
CI8-0010	Clear 10 1/4" Plate Dome	55 oz.	--	6.16	12.16	4/63	252	8	
CI8-0004	Clear 4 oz./5 oz. Bowl Cover	6 oz.	--	5.10	9.03	12/84	1008	12	
YCI8-0012	Clear 12 oz. Bowl Cover	22 oz.	--	2.89	7.30	6/84	504	14	
YCI8-0028	Clear Dome for 28 oz. Bowl	--	8 dia. x 1.5 deep	6.32	13.39	6/84	504	18	
YCI8-0030	Clear Dome Lid for 30 oz. Foam Bowls	--	8 dia. x 1 deep	6.90	14.00	6/84	500	8	
YCI8-0045	Clear Entree Platter Dome	26 oz.	9 1/2 x 7 x 1	3.50	13.80	6/84	500	45	
85-910*	Clear Oval Platter Dome (Premier)	--	--	4.50	9.60	2/125	250	12	
85914000000Y	Clear Platter Dome (Premier)	--	10 x 12 1/2	8.08	18.43	4/75	300	8	
85975000000Y	Clear Casserole Dome (Premier)	--	--	2.60	8.81	8/63	504	24	

### Carrying Trays

Product Number	Description	Capacity (fl. oz.)	Dimension (in inches)	Case		Packing	
				Cube	Approx Wt.	Sleeve	Case
1S	White Snack Tray	--	5 13/64 x 5 13/64 x 39/64	3.20	5.30	1000	1000
2S	White Snack Tray	--	8 13/64 x 5 45/64 x 39/64	2.70	4.80	500	500
4S	White Snack Tray	--	9 1/8 x 7 1/8 x 39/64	3.80	6.60	500	500
8S	White Snack Tray	--	10 x 8 x 39/64	4.60	8.30	500	500
10S	White Carry Tray	--	10 3/4 x 5 3/4 x 39/64	3.70	6.30	500	500
12S	White Carry Tray	--	11 x 9 x 39/64	3.10	5.80	250	250
17S	White Carry Tray	--	8 5/16 x 4 13/16 x 39/64	5.40	8.10	1000	1000
20S	White Carry Tray	--	8 45/64 x 6 13/64 x 39/64	3.20	5.60	1000	1000
1216	White Carry Tray	--	12 1/2 x 16 1/8 x 3/4	3.00	7.10	100	100
BTH1-1216	Boxed 1216	--	12 1/2 x 16 1/8 x 3/4	4.04	8.28	100	100
2014	White Carry Tray	--	10 x 14 x 1	4.90	10.60	200	200
TH1-0034	White Carry Tray	--	12 x 9	4.12	6.10	250	250
TK1-0136	White Laminated Serving Tray	--	18 x 14	4.52	7.90	100	100
1S Black	Black Snack Tray	--	5 13/64 x 5 13/64 x 39/64	3.20	6.90	1000	1000
2S Black	Black Snack Tray	--	8 13/64 x 5 45/64 x 39/64	3.00	5.60	500	500
4S Black	Black Snack Tray	--	9 1/8 x 7 1/8 x 39/64	4.10	8.50	500	500
8S Black	Black Snack Tray	--	10 x 8 x 39/64	5.00	9.60	500	500
10S Black	Black Carry Tray	--	10 3/4 x 5 3/4 x 39/64	3.70	7.30	500	500
12S Black	Black Carry Tray	--	11 x 9 x 39/64	6.90	2.96	250	250
17S Black	Black Carry Tray	--	8 5/16 x 4 13/16 x 39/64	9.80	4.98	1000	1000

For a complete list of Supermarket and Processor Trays please contact your Pactiv Sales Representative.

## Foam School Lunch Trays



YTH105000000



YTHB05000000



0TH106010000

## Molded Fiber Carry-Safe® Cafeteria/Compartment Trays

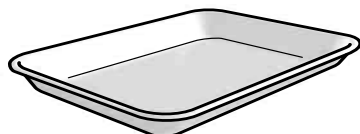

M53-7503, M53-7534



M53-1418

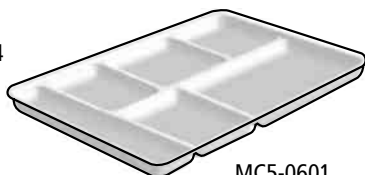

MC5-0601



M60-8000Y

## EarthChoice® Bagasse Blend Tableware

YC18-00060000



MC500120001



MC500160001



MC500060001



MC500070001



YMC500090002



YMC500110002

CI8-0010

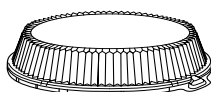

MC500440002



MC500100002

85910

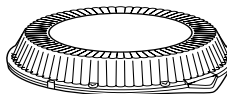

MC500430001

85914000000Y

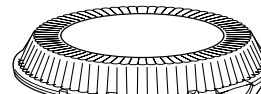

YMC500470001

**\*\* New Improved Rim Design for Greater Strength**

## Molded Fiber Pulpex® Plates, Bowl and Pizza Circle



M627529

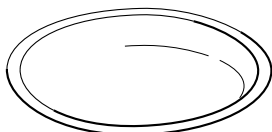

YM627510

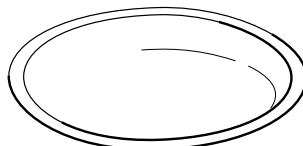

YM627513

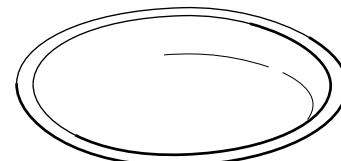

YM627515



### Foam School Lunch Trays

Product Number	Description	Capacity (fl. oz.)	Dimension (in inches)	Case		Packing	
				Cube	Approx. Wt.	Sleeve	Case
YTH105000000	White 5-Compartment Tray	--	8 1/4 x 10 1/4	4.84	12.46	4/125	500
YTHB05000000	Black 5-Compartment Tray	--	8 1/4 x 10 1/4	4.84	12.46	4/125	500
OTH106010000	White 6-Compartment Tray	--	8 1/2 x 11 1/2	6.19	15.84	4/125	500

### Molded Fiber Carry-Safe® Cafeteria/Compartment Trays

Product Number	Description	Top Out	Dimensions (in inches)			Vert. Depth (in inches)	Case Cube	Case Wt.	Case Pack
			Top In	Bottom					
M53-7503	9" x 12" Natural Cafeteria Tray	9 x 12	9 x 11 3/4	8 1/4 x 11 1/8	1	3.93	26.50	250	
M53-7534	9" x 12" Tan Cafeteria Tray	9 x 12	9 x 11 3/4	8 1/4 x 11 1/8	1	3.93	26.50	250	
M53-1418	14" x 18" Natural Cafeteria Tray	14 3/4 x 18 3/8	13 3/4 x 17 1/2	13 x 16 5/8	1	2.81	28.46	100	
MC5-0601	6 Senior White 6-Compartment Tray 125/Slv.	8 1/2 x 12 1/2	8 x 12	7 1/8 x 11 1/16	1	1.76	23.20	250	
M60-8000Y	5 Sophomore White 5-Compartment Tray 250/Slv.	8 1/2 x 10 1/2	7 5/16 x 9 15/16	6 3/4 x 8 3/4	1	2.57	34.80	500	
MC5-7603	6 Junior White 5-Compartment Tray 250/Slv.	10 3/4 x 10 3/4	10 3/8 x 10 3/8	9 7/16 x 9 7/16	1	1.68	22.44	250	

### EarthChoice® Bagasse Blend Tableware

Product Number	Description	Capacity (fl. oz.)	Dimensions (in inches)			Vert. Depth (in inches)	Case Cube	Case Wt.	Case Sleeve	Case Pack	Cases/ Unit Load
			Top Out	Top In	Bottom						
MC500120001	12 oz. Bagasse Blend Bowl	12	6 3/8	5	3 3/8	1 1/2	2.42	24.26	8/125	1000	18
MC500160001	16 oz. Bagasse Blend Bowl	16	6 1/2	5 7/8	3 7/8	1 1/2	2.73	28.11	8/125	1000	18
MC500060001	6" Bagasse Blend Snack Plate	--	6	4 7/8	4	5/8	1.32	19.29	8/125	1000	36
YCI800060000	Clear Dome for MC5-0006	--	--	--	--	--	4.53	9.32	8/63	504	12
MC500070001	6.75" Bagasse Blend Snack Plate	--	6 3/4	5 3/4	5	5/8	1.93	20.84	8/125	1000	36
YMC500090002	8.75" Bagasse Blend Plate	--	8 3/4	7 3/8	6	3/4	1.34	17.64	4/125	500	30
YMC500110002	8.75" Bagasse Blend 3-Compartment Plate	--	8 3/4	7 3/8	6	3/4	1.24	17.64	4/125	500	40
MC500440002	10" Bagasse Blend 3-Compartment Plate	--	10	8 1/4	7	1	2.74	25.91	4/125	500	20
MC500100002	10" Bagasse Blend Plate (New Rim Design)	--	10	8 1/2	7 3/8	3/4	1.89	25.90	4/125	500	20
C18-00100000	Clear Dome for 10" Plates	--	--	--	--	--	6.16	12.16	4/63	252	8
MC500430001	7.5" x 10" Bagasse Blend Oval Platter	--	7 1/2 x 10	6 1/8 x 8 3/4	4 1/2 x 7	1	1.71	19.08	4/125	500	36
85910	Clear Oval Dome for MC500430001	--	--	--	--	--	4.20	8.03	4/63	252	12
YMC500470001	9.875" x 12.5 Bagasse Blend Oval Platter	--	9 7/8 x 12 1/2	8 7/8 x 11 1/2	7 1/4 x 9 3/4	1	2.31	33.00	4/125	500	24
8591400000Y	Clear Oval Dome for MC500470001	--	10 x 12 1/2	--	--	--	8.08	18.43	4/753	300	8

### Molded Fiber Pulpex® Plates and Bowl

Product Number	Description	Top Out	Dimensions (in inches)			Vert. Depth	Cube	Case Approx. Wt.	Case Pack
			Top In	Bottom					
M627529	6" Natural Plate	6	5 7/16	4 7/16	5/8	2.33	19.67	1000	
YM627510	8" Natural Plate	8	7 1/2	5 7/8	53/64	1.79	16.97	500	
YM627513	9" Natural Plate	9	8 23/32	6 11/16	5/8	1.87	21.53	500	
YM627515	10" Natural Plate	10	9 1/4	7 5/8	51/64	2.54	25.67	500	

## Portion Cups and Lids

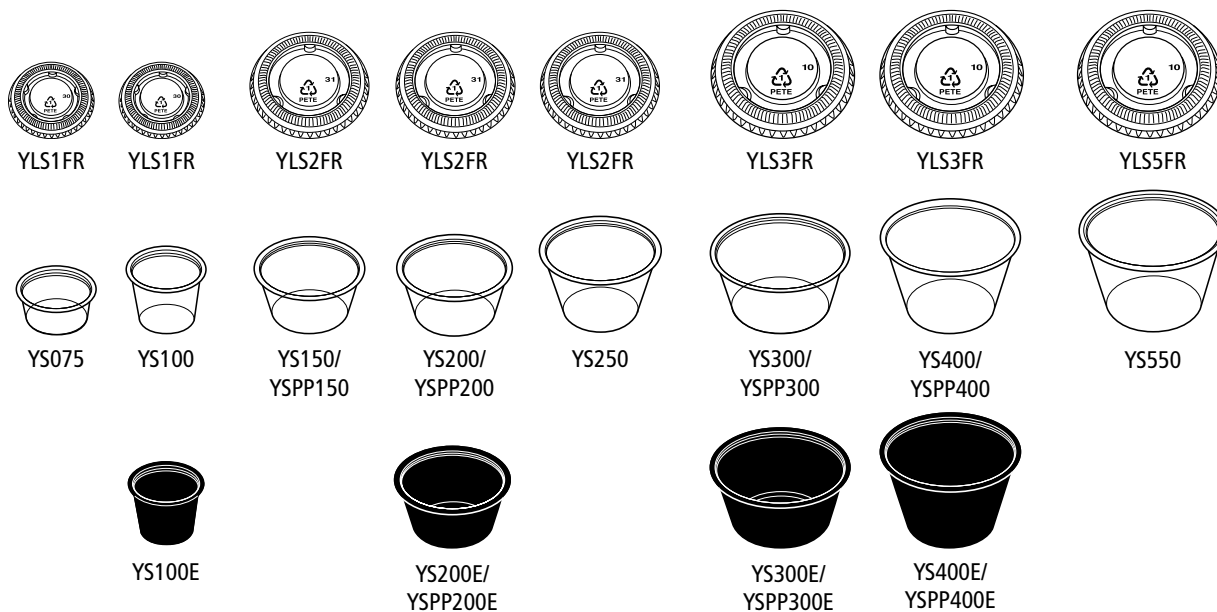

## Meadoware® Impact® Tableware

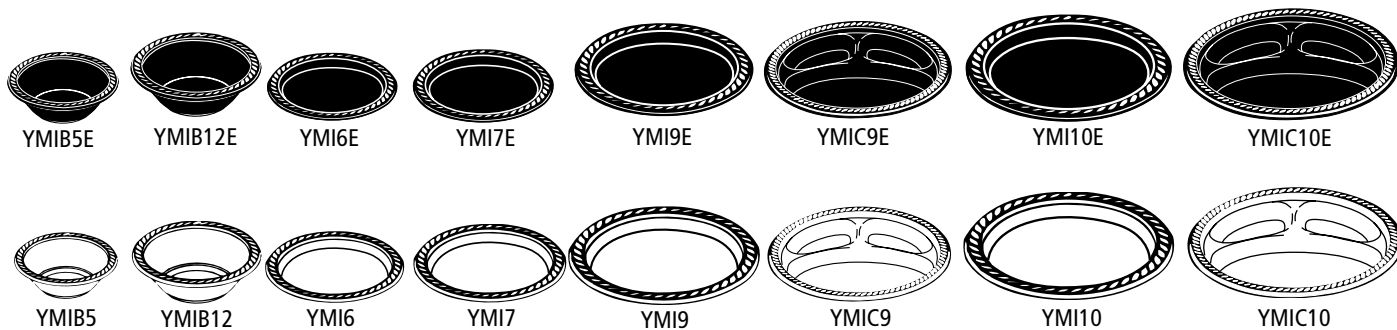

## Prairieware® Impact® Tableware

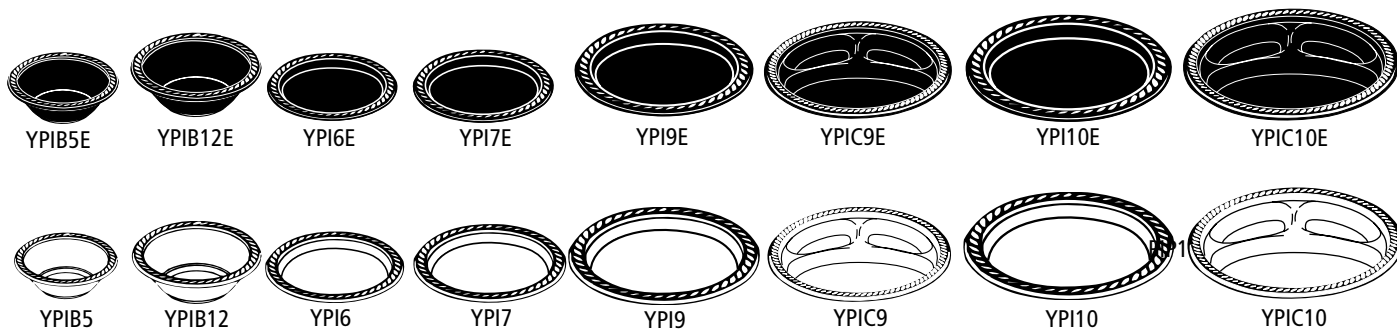

## Portion Cups and Lids

Product Number	Description	Lid Size	Cube	Case	Approx Wt.	Sleeve	Packing	Case
<b>PET Portion Cups</b>								
<b>Item #</b>								
YS075	0.75 oz. Translucent Portion Cup	K	1.58		14.50	20/250		5,000
YS100	1.0 oz. Translucent Portion Cup	K	1.58		17.00	20/250		5,000
YS150	1.5 oz. Translucent Portion Cup	H	1.50		11.20	12/200		2,400
YS200	2.0 oz. Translucent Portion Cup	H	1.50		12.90	12/200		2,400
YS250	2.5 oz. Translucent Portion Cup	H	1.50		15.50	12/200		2,400
YS300	3.25 oz. Translucent Portion Cup	F	2.01		18.75	12/200		2,400
YS400	4.0 oz. Translucent Portion Cup	F	2.01		20.50	12/200		2,400
YS550	5.5 oz. Translucent Portion Cup	M	2.65		26.70	10/250		2,500
YS100E	1.0 oz. Ebony Portion Cup	K	1.58		17.00	20/250		5,000
YS200E	2.0 oz. Ebony Portion Cup	H	1.50		12.70	12/200		2,400
YS300E	3.25 oz. Ebony Portion Cup	F	2.10		18.75	12/200		2,400
YS400E	4.0 oz. Ebony Portion Cup	F	2.10		20.50	10/250		2,500
<b>Polypropylene Portion Cups</b>								
YSPP150	1.5 oz. Natural PP Portion Cup	H	1.32		11.46	10/250		2,500
YSPP200	2.0 oz. Natural PP Portion Cup	H	1.29		12.20	12/200		2,400
YSPP200E	2.0 oz. Ebony PP Portion Cup	H	1.29		12.20	12/200		2,400
YSPP300	3.25 oz. Natural PP Portion Cup	F	1.85		19.79	10/250		2,500
YSPP300E	3.25 oz. Ebony PP Portion Cup	F	1.85		19.79	10/250		2,500
YSPP400	4.0 oz. Natural PP Portion Cup	F	2.06		20.50	12/200		2,400
YSPP400E	4.0 oz. Ebony PP Portion Cup	F	2.06		20.50	12/200		2,400
<b>Portion Cup Lids</b>								
YLS1FR	Clear Portion Cup Lid (fits 0.50, 0.75 & 1 oz.)	K	0.82		4.75	25/100		2,500
YLS2FR	Clear Portion Cup Lid (fits 1.5, 2.0 & 2.5 oz.)	H	1.44		8.20	24/100		2,400
YLS3FR	Clear Portion Cup Lid (fits 3.25 & 4 oz.)	F	1.97		11.25	24/100		2,400
YLS5FR	Clear Portion Cup Lid (fits 5.5 oz.)	M	2.44		14.75	25/100		2,500

## Meadoware® Impact® Tableware

Product Number	White	Black	Description	Cube	Case	Approx Wt	Sleeve	Packing	Case
YMIB5		YMIB5E	5 oz. Bowl	0.70		12.00	8/125		1000
YMIB12		YMIB12E	12 oz. Bowl	1.07		15.75	8/125		1000
YMI6		YMI6E	6" Plate	0.83		12.25	8/125		1000
YMI7		YMI7E	7" Plate	0.96		16.26	8/125		1000
YMI9		YMI9E	9" 1-Compartment Plate	0.83		15.20	4/100		500
YMIC9		YMIC9E	9" 3-Compartment Plate	0.90		16.00	4/100		500
YMI10		YMI10E	10.25" 1-Compartment Plate	1.36		23.10	4/100		500
YMIC10		YMIC10E	10.25" 3-Compartment Plate	1.33		26.20	4/100		500

## Prairieware® Impact® Tableware

Product Number	White	Black	Description	Cube	Case	Approx Wt	Sleeve	Packing	Case
YPIB5		YPIB5E	5 oz. Bowl	0.78		13.00	8/125		1000
YPIB12		YPIB12E	12 oz. Bowl	1.08		20.20	8/125		1000
YPI6		YPI6E	6" Plate	0.93		18.60	8/125		1000
YPI7		YPI7E	7" Plate	1.26		26.00	8/125		1000
YPI9		YPI9E	9" 1-Compartment Plate	1.13		23.00	4/100		500
YPIC9		YPIC9E	9" 3-Compartment Plate	1.18		26.20	4/100		500
YPI10		YPI10E	10.25" 1-Compartment Plate	1.35		30.00	4/100		500
YPIC10		YPIC10E	10.25" 3-Compartment Plate	1.40		31.00	4/100		500
N/A		PIP11E	9" x 11" Platter	1.45		31.00	4/125		500

# Newspring ellipso™ Portion Cups

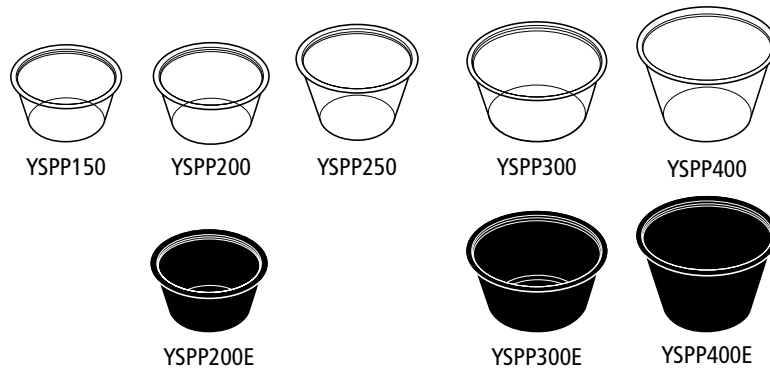
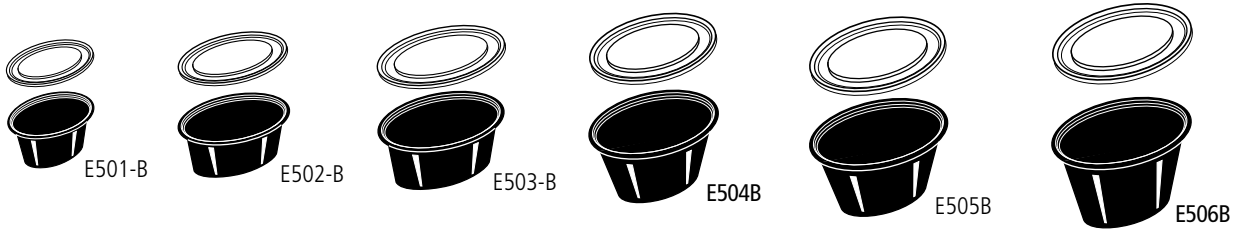
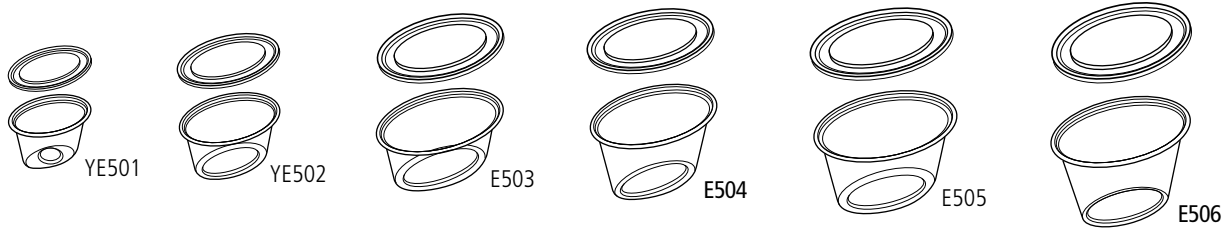

# Newspring O'Smile® Cutlery



## Newspring ellipso™ Portion Cups

Product #	Description	Color	Case Pack	Case Cube	Case Weight (lbs.)	Pallet Count	Ti/Hi
<b>Combo Packs</b>							
YE501	1 oz. base w/ natural lid combo	White / Black	500 ea.	0.79	9.36	69	23/3
YE502	2 oz. base w/ natural lid combo	White / Black	500 ea.	1.29	14.00	42	14/3
E503	3 oz. base w/ natural lid combo	White / Black	500 ea.	1.11	8.39	45	9/5
E504	4 oz. base w/ natural lid combo	White / Black	500 ea.	1.24	11.49	36	9/4
E505	5 oz. base w/ natural lid combo	White / Black	500 ea.	1.57	15.06	32	8/4
E506	6 oz. base w/ natural lid combo	White / Black	500 ea.	1.63	15.74	32	8/4
<b>Bulk Packs</b>							
E1001	1 oz. portion cup base only	White / Black	1,000	0.40	6.26	125	25/5
E1001LD	Lid fits 1 oz. portion cup	Natural	1,000	0.50	4.21	91	13/7
E1002	2 oz. portion cup base only	White / Black	1,000	0.64	7.61	80	16/5
E1002LD	Lid fits 2 oz. portion cup	Natural	1,000	0.79	6.10	64	16/4
E1003	3 oz. portion cup base only	White / Black	1,000	0.85	12.00	60	12/5
E1004	4 oz. portion cup base only	White / Black	1,000	0.97	14.75	48	12/4
E1034LD	Lid fits 3 & 4 oz. portion cups	Natural	1,000	1.33	6.58	40	10/4
E1005	5 oz. portion cup base only	White / Black	1,000	1.34	18.43	36	9/4
E1006	6 oz. portion cup base only	White / Black	1,000	1.34	19.99	36	9/4
E1056LD	Lid fits 5 & 6 oz. portion cups	Natural	1,000	1.78	12.12	28	7/4

## Polypropylene Portion Cups

Product Number	Description	Lid Size	Cube	Approx Wt.	Sleeve	Case Pack
YSPP150	1.5 oz. Natural PP Portion Cup	H	1.32	11.46	10/250	2,500
YSPP200	2.0 oz. Natural PP Portion Cup	H	1.29	12.20	12/200	2,400
YSPP200E	2.0 oz. Ebony PP Portion Cup	H	1.29	12.20	12/200	2,400
YSPP300	3.25 oz. Natural PP Portion Cup	F	1.85	19.79	10/250	2,500
YSPP300E	3.25 oz. Ebony PP Portion Cup	F	1.85	19.79	10/250	2,500
YSPP400	4.0 oz. Natural PP Portion Cup	F	2.06	20.50	12/200	2,400
YSPP400E	4.0 oz. Ebony PP Portion Cup	F	2.06	20.50	12/200	2,400
<b>Portion Cup Lids</b>						
YLS2FR	Clear Portion Cup Lid	H	1.44	8.20	24/100	2,400
YLS3FR	Clear Portion Cup Lid	F	1.97	11.25	20/120	2,400

## Newspring O'Smile® Cutlery

Product #	Description	Cs Pack	Cs Cube	Cs Wt (lbs.)	Pallet Count	Ti/Hi
NF1000	White plastic forks	1000	1.37	7.36	40	10/4
NK1000	White plastic knives	1000	0.58	7.13	91	13/7
NS1000	White plastic soup spoons	1000	1.16	7.94	40	10/4
NT1000	White plastic teaspoons	1000	1.16	7.56	40	10/4
YPZ15W	White plastic pizza stands	1000	1.06	5.00	50	10/5

Prairieware® PS Extra Heavy Weight Cutlery – Bulk

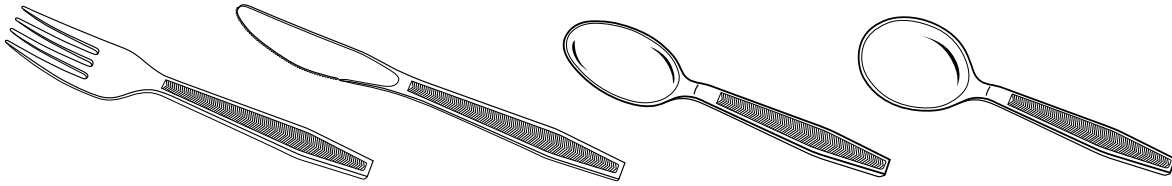

Prairiehollow® PS Heavy Weight Full Length Cutlery – Bulk

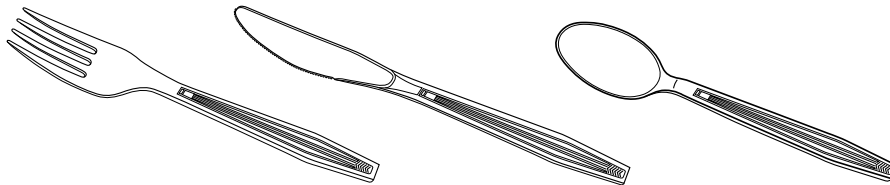

Meadoware® PS Medium/Heavy Wt. Cutlery – Bulk

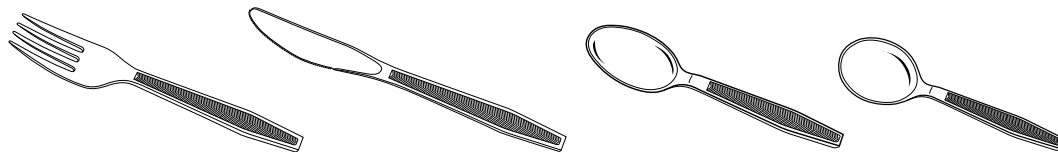

**Prairieware® PS Extra Heavy Weight Cutlery – Bulk**

Product #	Color	Description	Case Pack	Case Cube	Case Wt. (lbs.)	Pallet Count
YPW-F	Beige	Fork - Polystyrene Heavyweight Full-Length	1,000	0.93	15.50	60
YPW-FC	Clear	Fork - Polystyrene Heavyweight Full-Length	1,000	0.93	15.50	60
YPW-FE	Black	Fork - Polystyrene Heavyweight Full-Length	1,000	0.93	15.50	60
YPW-FW	White	Fork - Polystyrene Heavyweight Full-Length	1,000	0.93	15.50	60
YPW-K	Beige	Knife - Polystyrene Heavyweight Full-Length	1,000	0.55	15.25	96
YPW-KC	Clear	Knife - Polystyrene Heavyweight Full-Length	1,000	0.55	15.25	96
YPW-KE	Black	Knife - Polystyrene Heavyweight Full-Length	1,000	0.55	15.25	96
YPW-KW	White	Knife - Polystyrene Heavyweight Full-Length	1,000	0.55	15.25	96
YPW-S	Beige	Spoon - Polystyrene Heavyweight Full-Length	1,000	0.65	10.25	80
YPW-SC	Clear	Spoon - Polystyrene Heavyweight Full-Length	1,000	0.65	10.25	80
YPW-SE	Black	Spoon - Polystyrene Heavyweight Full-Length	1,000	0.65	10.25	80
YPW-SW	White	Spoon - Polystyrene Heavyweight Full-Length	1,000	0.65	10.25	80
YPW-SS	Beige	Soup Spoon - Polystyrene Heavyweight Full-Length	1,000	0.65	10.50	80
YPW-SSC	Clear	Soup Spoon - Polystyrene Heavyweight Full-Length	1,000	0.65	10.50	80
YPW-SSE	Black	Soup Spoon - Polystyrene Heavyweight Full-Length	1,000	0.65	10.50	80
YPW-SSW	White	Soup Spoon - Polystyrene Heavyweight Full-Length	1,000	0.65	10.50	80

**Prairiehollow® PS Heavy Weight Full Length Cutlery – Bulk**

Product #	Color	Description	Case Pack	Case Cube	Case Wt. (lbs.)	Pallet Count
YPH-F	Beige	Fork - Hollow Polystyrene Heavyweight Full-Length	1,000	0.93	12.50	60
YPH-FC	Clear	Fork - Hollow Polystyrene Heavyweight Full-Length	1,000	0.93	12.50	60
YPH-FE	Black	Fork - Hollow Polystyrene Heavyweight Full-Length	1,000	0.93	12.50	60
YPH-FW	White	Fork - Hollow Polystyrene Heavyweight Full-Length	1,000	0.93	12.50	60
YPHK	Beige	Knife - Hollow Polystyrene Heavyweight Full-Length	1,000	0.66	12.25	80
YPH-KC	Clear	Knife - Hollow Polystyrene Heavyweight Full-Length	1,000	0.66	12.25	80
YPH-KE	Black	Knife - Hollow Polystyrene Heavyweight Full-Length	1,000	0.66	12.25	80
YPH-KW	White	Knife - Hollow Polystyrene Heavyweight Full-Length	1,000	0.66	12.25	80
YPH-S	Beige	Spoon - Hollow Polystyrene Heavyweight Full-Length	1,000	0.54	8.00	100
YPH-SC	Clear	Spoon - Hollow Polystyrene Heavyweight Full-Length	1,000	0.54	8.00	100
YPH-SE	Black	Spoon - Hollow Polystyrene Heavyweight Full-Length	1,000	0.54	8.00	100
YPH-SW	White	Spoon - Hollow Polystyrene Heavyweight Full-Length	1,000	0.54	8.00	100

**Meadoware® PS Medium/Heavy Wt. Cutlery – Bulk**

Product #	Color	Description	Case Pack	Case Cube	Case Wt. (lbs.)	Pallet Count
YMW-F	Beige	Fork - Polystyrene Heavyweight Mid-Length	1,000	0.67	8.25	80
YMW-FC	Clear	Fork - Polystyrene Heavyweight Mid-Length	1,000	0.67	8.25	80
YMW-FE	Black	Fork - Polystyrene Heavyweight Mid-Length	1,000	0.67	8.25	80
YMW-FW	White	Fork - Polystyrene Heavyweight Mid-Length	1,000	0.67	8.25	80
YMW-K	Beige	Knife - Polystyrene Heavyweight Mid-Length	1,000	0.44	10.20	120
YMW-KC	Clear	Knife - Polystyrene Heavyweight Mid-Length	1,000	0.44	10.20	120
YMW-KE	Black	Knife - Polystyrene Heavyweight Mid-Length	1,000	0.44	10.20	120
YMW-KW	White	Knife - Polystyrene Heavyweight Mid-Length	1,000	0.44	10.20	120
YMW-S	Beige	Spoon - Polystyrene Heavyweight Mid-Length	1,000	0.67	8.10	80
YMW-SC	Clear	Spoon - Polystyrene Heavyweight Mid-Length	1,000	0.67	8.10	80
YMW-SE	Black	Spoon - Polystyrene Heavyweight Mid-Length	1,000	0.67	8.10	80
YMW-SW	White	Spoon - Polystyrene Heavyweight Mid-Length	1,000	0.67	8.10	80
YMW-SS	Beige	Soup Spoon - Polystyrene Heavyweight Mid-Length	1,000	0.67	9.20	80
YMW-SSC	Clear	Soup Spoon - Polystyrene Heavyweight Mid-Length	1,000	0.67	9.20	80
YMW-SSE	Black	Soup Spoon - Polystyrene Heavyweight Mid-Length	1,000	0.67	9.20	80
YMW-SSW	White	Soup Spoon - Polystyrene Heavyweight Mid-Length	1,000	0.67	9.20	80

Fieldware® PP Medium/Std Weight Cutlery – Bulk Cutlery – Bulk

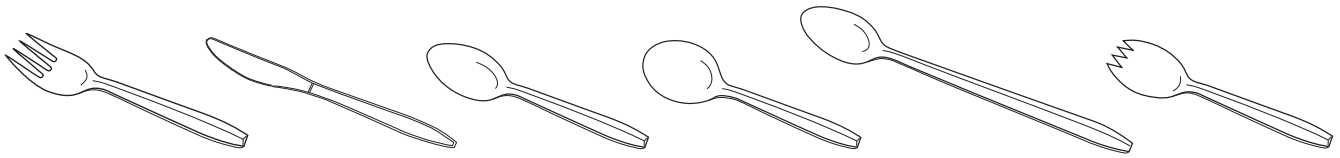

Prairieware® PS Extra Heavy Weight Cutlery –

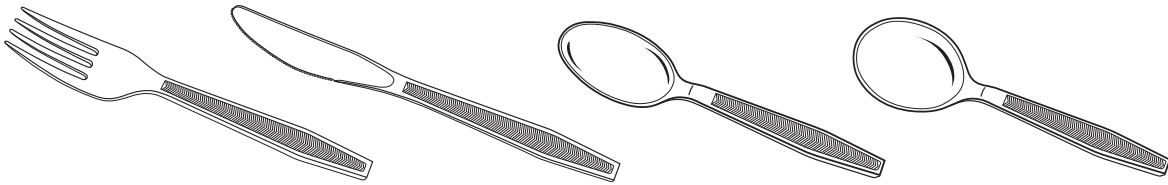

Gardenware® PP Heavy Weight Full Length Cutlery

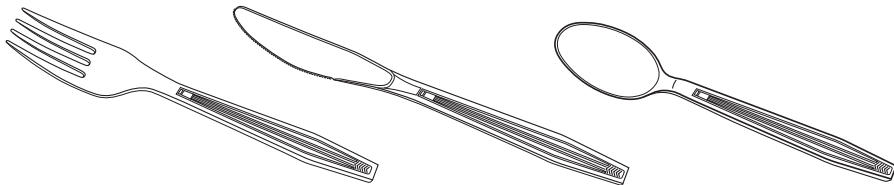



**Fieldware® PP Medium/Std Weight Cutlery – Bulk Cutlery – Bulk**

Product #	Color	Description	Case Pack	Case Cube	Case Wt. (lbs.)	Pallet Count
YFW-F	Beige	Fork- Polypropylene Mediumweight	1,000	0.96	6.50	56
YFW-FE	Black	Fork- Polypropylene Mediumweight	1,000	0.96	6.50	56
YFW-FW	White	Fork -Polypropylene Mediumweight	1,000	0.96	6.50	56
YFW-K	Beige	Knife - Polypropylene Mediumweight	1,000	0.37	6.10	140
YFW-KE	Black	Knife - Polypropylene Mediumweight	1,000	0.37	6.10	140
YFW-KW	White	Knife - Polypropylene Mediumweight	1,000	0.37	6.10	140
YFW-S	Beige	Spoon - Polypropylene Mediumweight	1,000	0.74	6.00	72
YFW-SE	Black	Spoon - Polypropylene Mediumweight	1,000	0.74	6.00	72
YFW-SW	White	Spoon - Polypropylene Mediumweight	1,000	0.74	6.00	72
YFWSS	Beige	Soup Spoon - Polypropylene Mediumweight	1,000	1.09	7.11	48
YFWSSSE	Black	Soup Spoon - Polypropylene Mediumweight	1,000	1.09	7.11	48
YFWSSSW	White	Soup Spoon - Polypropylene Mediumweight	1,000	1.09	7.11	48
YFW-PW	White	Parfait Spoon - Polypropylene Mediumweight	1,000	1.49	8.10	36
YFW-QW	White	Spork - Polypropylene Mediumweight	1,000	0.74	6.35	72

**PrairieWare® PS Extra Heavy Weight Cutlery – Boxed**

Product #	Color	Description	Case Pack	Case Cube	Case Wt. (lbs.)	Pallet Count
YPWF-BX	Beige	Fork - Polystyrene Heavyweight Full-Length	10/100	0.96	17.00	52
YPWFC-BX	Clear	Fork - Polystyrene Heavyweight Full-Length	10/100	0.96	17.00	52
YPWFE-BX	Black	Fork - Polystyrene Heavyweight Full-Length	10/100	0.96	17.00	52
YPWFW-BX	White	Fork - Polystyrene Heavyweight Full-Length	10/100	0.96	17.00	52
YPWK-BX	Beige	Knife - Polystyrene Heavyweight Full-Length	10/100	0.73	15.75	72
YPWK-BX	Clear	Knife - Polystyrene Heavyweight Full-Length	10/100	0.73	15.75	72
YPWKE-BX	Black	Knife - Polystyrene Heavyweight Full-Length	10/100	0.73	15.75	72
YPWKW-BX	White	Knife - Polystyrene Heavyweight Full-Length	10/100	0.73	15.75	72
YPWS-BX	Beige	Spoon - Polystyrene Heavyweight Full-Length	10/100	0.73	11.50	70
YPWSC-BX	Clear	Spoon - Polystyrene Heavyweight Full-Length	10/100	0.73	11.50	70
YPWSE-BX	Black	Spoon - Polystyrene Heavyweight Full-Length	10/100	0.73	11.50	70
YPWSW-BX	White	Spoon - Polystyrene Heavyweight Full-Length	10/100	0.73	11.50	70
YPWSS-BX	Beige	Soup Spoon - Polystyrene Heavyweight Full-Length	10/100	0.73	11.75	70
YPWSSC-BX	Clear	Soup Spoon - Polystyrene Heavyweight Full-Length	10/100	0.73	11.75	70
YPWSSSE-BX	Black	Soup Spoon - Polystyrene Heavyweight Full-Length	10/100	0.73	11.75	70
YPWSSW-BX	White	Soup Spoon - Polystyrene Heavyweight Full-Length	10/100	0.73	11.75	70

**Gardenware® PP Heavy Weight Full Length Cutlery**

Product #	Color	Description	Case Pack	Case Cube	Case Wt. (lbs.)	Pallet Count
YGWFWCH	White	Fork - Polypropylene Heavyweight Full-Length	1000	0.67	13.42	78
YGWFECH	Black	Fork - Polypropylene Heavyweight Full-Length	1000	0.67	13.42	78
YGWKWCH	White	Knife - Polypropylene Heavyweight Full-Length	1000	0.61	13.42	100
YGWKECH	Black	Knife - Polypropylene Heavyweight Full-Length	1000	0.61	13.42	100
YGWSWCH	White	Spoon - Polypropylene Heavyweight Full-Length	1000	0.57	9.46	180
YGWSECH	Black	Spoon - Polypropylene Heavyweight Full-Length	1000	0.57	9.46	180
GKFWCH	White	Fork - Polypropylene Heavyweight Full-Length - 1 Pc. Wrapped	1000	0.92	14.52	75
GKFECH	Black	Fork - Polypropylene Heavyweight Full-Length - 1 Pc. Wrapped	1000	0.92	14.52	60
GKKWCH	White	Knife - Polypropylene Heavyweight Full-Length - 1 Pc. Wrapped	1000	0.84	14.52	75
GKKECH	Black	Knife - Polypropylene Heavyweight Full-Length - 1 Pc. Wrapped	1000	0.84	14.52	75
GKSWCH	White	Spoon - Polypropylene Heavyweight Full-Length - 1 Pc. Wrapped	1000	0.76	10.56	100
GKSECH	Black	Spoon - Polypropylene Heavyweight Full-Length - 1 Pc. Wrapped	1000	0.76	10.56	100
GKFKWCH	White	Fork - Polypropylene Heavyweight Full-Length - 2 Pc. Wrapped	1000	0.93	14.52	36
GKFECH	Black	Fork - Polypropylene Heavyweight Full-Length - 2 Pc. Wrapped	1000	0.93	14.52	36

Meadoware® PS Medium/Heavy Wt. Cutlery – Boxed

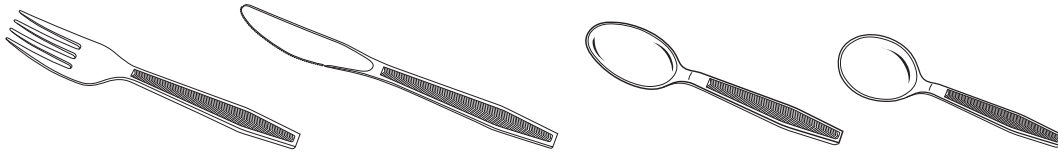

Prairieware® PS Heavy Weight Cutlery – Single Piece Wrapped

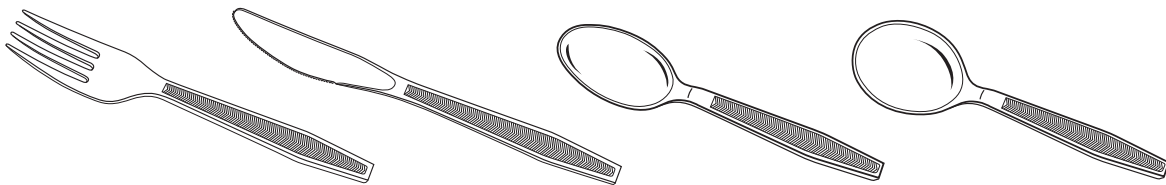

Meadoware® PS Medium/Heavy Wt. Cutlery – Single Piece Wrapped

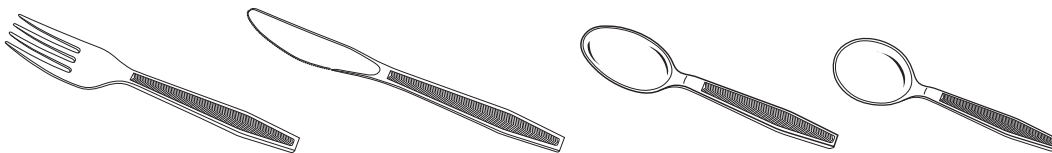

**Meadoware® PS Medium/Heavy Wt. Cutlery – Boxed**

Product #	Color	Description	Case Pack	Case Cube	Case Wt. (lbs.)	Pallet Count
YMWFC-BX	Clear	Fork - Polystyrene Heavyweight Mid-Length	10/100	0.76	9.75	70
YMWFE-BX	Black	Fork - Polystyrene Heavyweight Mid-Length	10/100	0.76	9.75	70
YMWFW-BX	White	Fork - Polystyrene Heavyweight Mid-Length	10/100	0.76	9.75	70
YMWKC-BX	Clear	Knife - Polystyrene Heavyweight Mid-Length	10/100	0.46	11.75	110
YMWKE-BX	Black	Knife - Polystyrene Heavyweight Mid-Length	10/100	0.46	11.75	110
YMWKW-BX	White	Knife - Polystyrene Heavyweight Mid-Length	10/100	0.46	11.75	110
YMWSC-BX	Clear	Spoon - Polystyrene Heavyweight Mid-Length	9/100	0.77	8.75	70
YMWSW-BX	White	Spoon - Polystyrene Heavyweight Mid-Length	9/100	0.77	8.75	70
YMWSSW-BX	White	Soup Spoon - Polystyrene Heavyweight Mid-Length	9/100	0.77	10.00	70

**Prairieware® PS Heavy Weight Cutlery – Single Piece Wrapped**

Product #	Color	Description	Case Pack	Case Cube	Case Wt. (lbs.)	Pallet Count
PK-F	Beige	Fork	1,000	3.06	17.78	12
PK-FC	Clear	Fork	1,000	3.06	17.78	12
PK-FE	Black	Fork	1,000	3.06	17.78	12
PK-FW	White	Fork	1,000	3.06	17.78	12
PK-K	Beige	Knife	1,000	1.57	17.50	24
PK-KE	Black	Knife	1,000	1.57	17.50	24
PK-KW	White	Knife	1,000	1.57	17.50	24
PK-S	Beige	Spoon	1,000	1.92	11.83	28
PK-SE	Black	Spoon	1,000	1.92	11.83	28
PK-SW	White	Spoon	1,000	1.92	11.83	28
PK-SS	Beige	Soup Spoon	1,000	1.92	12.27	28
PK-SSE	Black	Soup Spoon	1,000	1.92	12.27	28
PK-SSW	White	Soup Spoon	1,000	1.92	12.27	28

**Meadoware® PS Medium/Heavy Wt. Cutlery – Single Piece Wrapped**

Product #	Color	Description	Case Pack	Case Cube	Case Wt. (lbs.)	Pallet Count
MK-F	Beige	Fork	1,000	1.92	10.95	28
MK-FE	Black	Fork	1,000	1.92	10.95	28
MK-FW	White	Fork	1,000	1.92	10.95	28
MK-K	Beige	Knife	1,000	1.07	11.81	36
MK-KE	Black	Knife	1,000	1.07	11.81	36
MK-KW	White	Knife	1,000	1.07	11.81	36
MK-S	Beige	Spoon	1,000	1.92	10.28	28
MK-SE	Black	Spoon	1,000	1.92	10.28	28
MK-SW	White	Spoon	1,000	1.92	10.28	28
MK-SSE	Black	Soup Spoon	1,000	1.92	11.12	28
MK-SSW	White	Soup Spoon	1,000	1.92	11.12	28

Fieldware® PP Medium/Std Weight Cutlery – Single Piece Wrapped

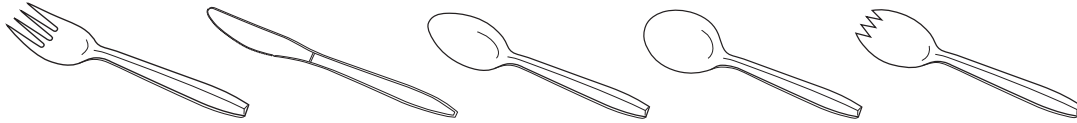

Prairieware® PS Extra Heavy Weight Cutlery – Kits

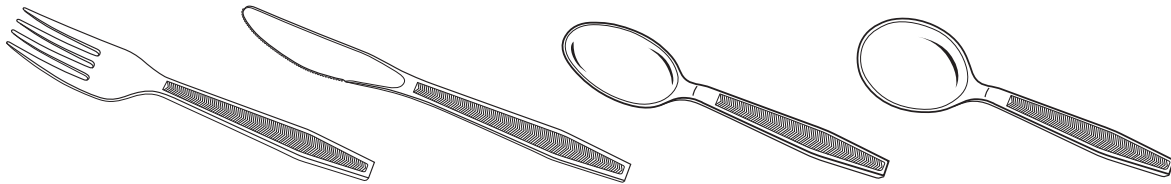

Meadoware® PS Medium/Heavy Weight Cutlery – Kits

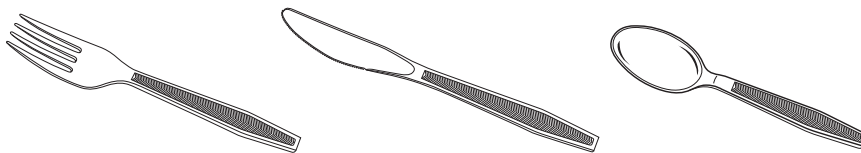

**Fieldware® PP Medium/Std Weight Cutlery – Single Piece**

Product #	Color	Description	Case Pack	Case Cube	Case Wt. (lbs.)	Pallet Count
FK-FW	White	Fork	1,000	1.92	7.07	28
FK-KW	White	Knife	1,000	1.07	7.75	36
FK-SW	White	Spoon	1,000	1.92	7.60	28
FK-SSW	White	Soup Spoon	1,000	1.92	7.80	28
FK-QW	White	Spork	1,000	1.92	8.43	28

**Prairieware® PS Exta Heavy Weight Cutlery – Kits**

Product #	Color	Description	Case Pack	Case Cube	Case Wt. (lbs.)	Pallet Count
PK-FK	Beige	Fork, Knife	500	1.92	17.62	28
PK-FKC	Clear	Fork, Knife	500	1.92	17.62	28
PK-FKE	Black	Fork, Knife	500	1.92	17.62	28
PK-FKE-N	Black	Fork, Knife, Napkin (17x 13)	250	1.92	10.08	28
PK-FKW	White	Fork, Knife	500	1.92	17.62	28
PK-FKW-N	White	Fork, Knife, Napkin (17x 13)	250	1.92	11.13	28
PK-FSK	Beige	Fork, Spoon, Knife	250	1.56	11.75	24
PK-FSKC	Clear	Fork, Spoon, Knife	250	1.56	11.75	24
PK-FSKE	Black	Fork, Spoon, Knife	250	1.56	11.75	24
PK-FSKE-N	Black	Fork, Spoon, Knife, Napkin (17 x 13)	250	1.92	13.53	28
PK-FSKW	White	Fork, Spoon, Knife	250	1.56	11.75	24
PK-FSKW-N	White	Fork, Spoon, Knife, Napkin (17 x 13)	250	1.92	13.53	28
PK-FSKW-NSP	White	Fork, Spoon, Knife, Napkin (17 x 13), Salt, Pepper	250	1.92	13.59	28
PK-SKE-N	Black	Spoon, Knife, Napkin (17 x 13)	250	1.92	9.72	28

**Meadoware® PS Medium/Heavy Weight Cutlery – Kits**

Product #	Color	Description	Case Pack	Case Cube	Case Wt. (lbs.)	Pallet Count
MK-FK	Beige	Fork, Knife	500	1.57	10.85	24
MK-FKC	Clear	Fork, Knife	500	1.57	10.85	24
MK-FKE	Black	Fork, Knife	500	1.57	10.85	24
MK-FKE-N	Black	Fork, Knife, Napkin (17 x 13)	250	1.92	8.29	28
MK-FKE-N-5	Black	Fork, Knife, Napkin (12.5 x 13)	500	2.61	15.48	16
MK-FK-NSP	Beige	Fork, Knife, Napkin (17 x 13), Salt, Pepper	250	1.92	8.90	28
MK-FKW	White	Fork, Knife	500	1.57	10.85	24
MK-FSKC	Clear	Fork, Spoon, Knife	250	1.07	8.58	36
MK-FSKE	Black	Fork, Spoon, Knife	250	1.07	8.58	36
MK-FSKE-N	Black	Fork, Spoon, Knife, Napkin (17 x 13)	250	1.92	10.17	28
MK-FSKE-NSP	Black	Fork, Spoon, Knife, Napkin (17 x 13), Salt, Pepper	250	1.92	10.17	28
MK-FSKW	White	Fork, Spoon, Knife	250	1.56	8.58	24
MK-FSKW-N	White	Fork, Spoon, Knife, Napkin (17 x 13)	250	1.92	10.17	28
MK-FSKW-NSP	White	Fork, Spoon, Knife, Napkin (17 x 13), Salt, Pepper	250	1.92	10.78	28
MK-FSKW-NSP-5	White	Fork, Spoon, Knife, Napkin (17 x 13), Salt, Pepper	500	2.45	16.76	24
MK-FW-N	White	Fork, Napkin (17 x 13)	500	1.96	10.29	28

Fieldware® PP Medium/Std Weight Cutlery – Kits

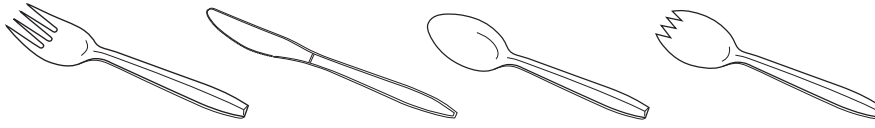

EarthChoice® PSM Cutlery



**Fieldware® PP Medium/Std Weight Cutlery – Kits**

Product #	Color	Description	Case Pack	Case Cube	Case Wt. (lbs.)	Pallet Count
FK-FKSSW-NSP	White	Fork, Knife, Soup Spoon, Napkin (13x12), Salt, Pepper	250	1.92	6.61	28
FK-FKW-N	White	Fork, Knife, Napkin (17x13)	250	1.36	5.74	35
FK-FKW-NSP	White	Fork, Knife, Napkin (17x13), Salt, Pepper	250	1.92	6.38	28
FK-FSKSSW	White	Fork, Spoon, Knife, Soup Spoon	250	1.36	7.72	35
FK-FSKW-5	White	Fork, Spoon, Knife	500	1.92	10.49	28
FK-FSKW-N	White	Fork, Spoon, Knife, Napkin (13x12)	250	1.92	7.32	28
FK-FSKW-N57	White	Fork, Spoon, Knife, Napkin (13x12), 5.75" White Milk	250	1.92	7.00	28
FK-FSKW-NSP	White	Fork, Spoon, Knife, Napkin (13x12), Salt, Pepper	250	1.92	7.81	28
FK-FSW-N57	White	Fork, Spoon, Napkin (13 x 12), 5.75" White Milk	500	2.61	10.16	16
FK-FW-N	White	Fork, Napkin (10 x 10)	1,000	2.61	11.70	16
FK-FW-N57	White	Fork, Napkin (10 x 8), 5.75" White Milk	1,000	2.61	11.22	16
FK-KW-N	White	Knife, Napkin (10 x 10)	1,000	2.61	11.70	16
FK-QW-N	White	Spork, Napkin (10 x 10)	1,000	2.61	11.70	16
FK-QW-SCHL	White	Spork, Napkin (10 x 8), 5.75" White Milk	1,000	2.61	11.57	16
FK-QW-SCHL2	White	Spork, Napkin (10 x 8), Spike Straw	1,000	2.61	11.87	16
FK-SW-N	White	Spoon, Napkin (10 x 10)	1,000	2.61	11.18	16
FK-SW-SCHL	White	Spoon, Napkin (10 x 8), 5.75" White Milk	1,000	2.61	11.57	16

**EarthChoice® PSM Cutlery**

Item Number	Description	Case		Case		Cases/ Unit Load
		Cube	Weight	Sleeve	Pack	
YPSMFTEC	EarthChoice® Full Length Heavy PSM Fork	0.91	14.50	10/100	1,000	60
YPSMKTEC	EarthChoice® Full Length Heavy PSM Knife	0.53	13.25	10/100	1,000	96
YPSMSTEC	EarthChoice® Full Length Heavy PSM Spoon	0.64	9.50	10/100	1,000	80
YPSMKFSKTSPEC	EarthChoice® Full Length Heavy Fork, Spoon, Knife, 13" x 17" Napkin, Salt & Pepper Packets Cutlery Kit	1.79	12.50	1/250	250	30





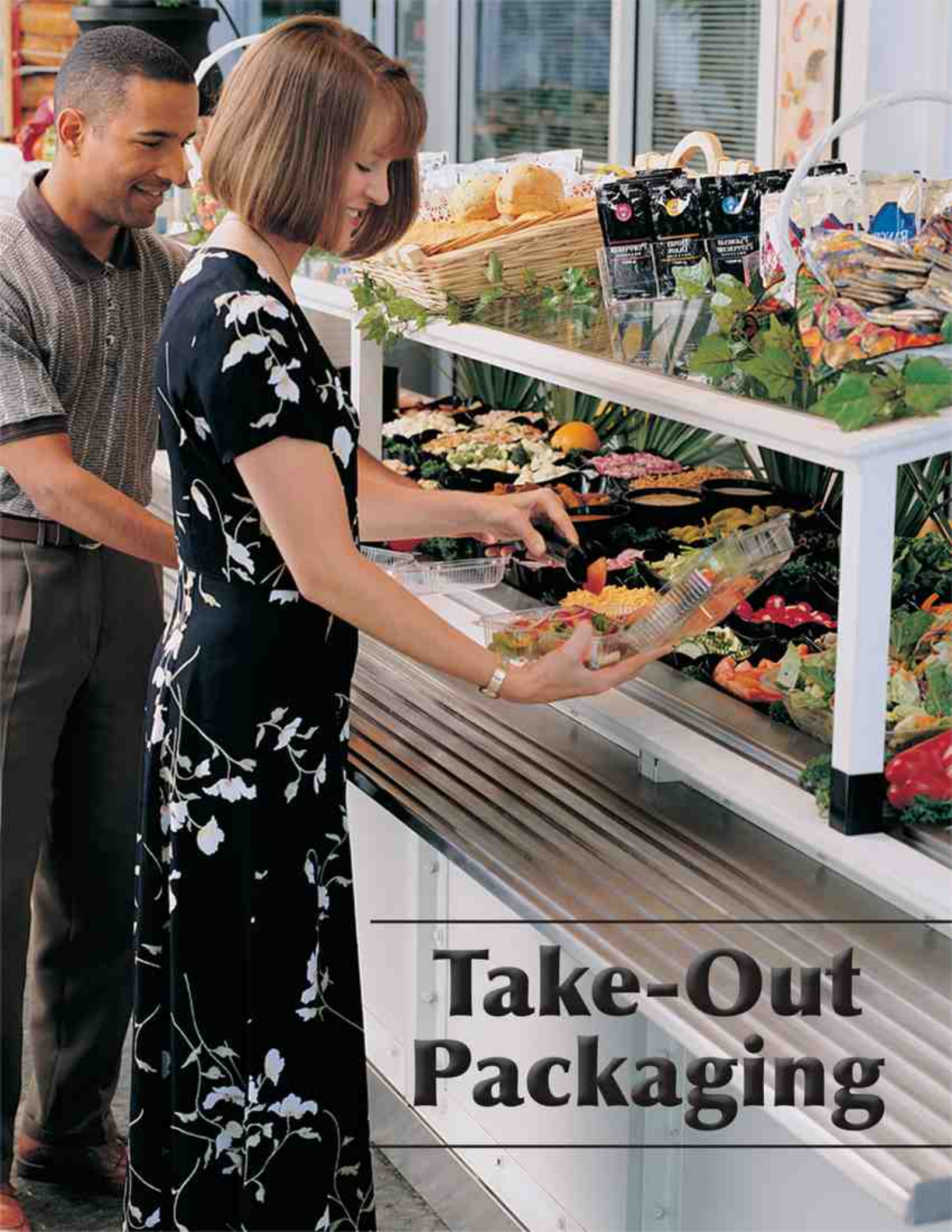

---

# Take-Out Packaging

---

Product Number	Description	Page
0CA910080000	8 OZ. CLEAR HINGED CONTAINER - RPET.....	121
0CA910120000	12 OZ. CLEAR HINGED CONTAINER - RPET.....	121
0CA910160000	16 OZ. CLEAR HINGED CONTAINER - RPET.....	121
0CA910240000	24 OZ. CLEAR HINGED CONTAINER - RPET.....	121
0CA910320000	32 OZ. CLEAR HINGED CONTAINER - RPET.....	121
0CA910480000	48 OZ. CLEAR HINGED CONTAINER - RPET.....	121
0CA910640000	64 OZ. CLEAR HINGED CONTAINER - RPET.....	121
OCASH0970	APET CLEAR HINGED 8" X 8" BAKERY CONTAINER.....	111
OCASH1030	APET CLEAR MEDIUM HINGED CONTAINER - DEEP.....	111
OCASH1110	APET CLEAR LARGE HINGED LID W/1 CMPT. TRAY.....	111
OCASH1120	APET CLEAR MEDIUM HINGED LID W/1-CMPT. TRAY.....	111
OCASH1123	APET CLEAR MEDIUM HINGED LID W/3-CMPT. TRAY.....	111
OCASH1124	APET CLEAR MEDIUM HINGED COOKIE CONTAINER.....	111
OCASH3025	APET CLEAR LARGE HINGED STRUDEL CONTAINER.....	111
OCASH9140	APET CLEAR HINGED 4 COUNT MUFFIN CONTAINER.....	111
OCASH9446	APET CLEAR 12 CUP CUPCAKE/MUFFIN CONTAINER - 2 1/2" CUP DIA.....	111
10839APT	8 OZ. CLEAR ROUND SHO-BOWLS® HINGEWARE W/FLAT LID.....	121
10841APT	8 OZ. CLEAR ROUND SHO-BOWLS® HINGEWARE W/DOME LID.....	121
10845APT	12 OZ. CLEAR ROUND SHO-BOWLS® HINGEWARE W/DOME LID.....	121
10847APT	16 OZ. CLEAR ROUND SHO-BOWLS® HINGEWARE W/FLAT LID.....	121
10849APT	16 OZ. CLEAR ROUND SHO-BOWLS® HINGEWARE W/DOME LID.....	121
10851APT	56 OZ. CLEAR ROUND SHO-BOWLS® HINGEWARE W/FLAT LID.....	121
10853APT	56 OZ. CLEAR ROUND SHO-BOWLS® HINGEWARE W/RIBBED DOME LID.....	121
10857APT	16 OZ. CLEAR ROUND SHO-BOWLS® HINGEWARE W/DOME LID.....	121
10863APT	32 OZ. CLEAR ROUND SHO-BOWLS® HINGEWARE W/FLAT LID.....	121
10865APT	32 OZ. CLEAR ROUND SHO-BOWLS® HINGEWARE W/DOME LID.....	121
10869APT	39 OZ. CLEAR ROUND SHO-BOWLS® HINGEWARE W/DOME LID.....	121
11970	REYNOLDS® 10" HINGEWARE.....	19
11974	REYNOLDS® 6" ENHANCED HINGEWARE.....	19
12016	REYNOLDS® 5" ENHANCED HINGEWARE.....	19
12091	REYNOLDS® 44 OZ. OCTAGONAL CLAMSHELL.....	121
12092	REYNOLDS® 33 OZ. OCTAGONAL CLAMSHELL.....	121
12093	REYNOLDS® 29 OZ. OCTAGONAL CLAMSHELL.....	121
12094	REYNOLDS® 22 OZ. OCTAGONAL CLAMSHELL.....	121
12095	REYNOLDS® 19 OZ. OCTAGONAL CLAMSHELL.....	121
12096	REYNOLDS® 16 OZ. OCTAGONAL CLAMSHELL.....	121
12761	REYNOLDS® GRANDSTAND™ 18 OZ. HINGED BOWL - BLACK BASE.....	111
12807	REYNOLDS® GRANDSTAND™ 18 OZ. HINGED BOWL - CLEAR BASE.....	111
12808	REYNOLDS® GRANDSTAND™ 28 OZ. HINGED BOWL - CLEAR BASE.....	111
12809	REYNOLDS® GRANDSTAND™ 35 OZ. HINGED BOWL - CLEAR BASE.....	111
12811	REYNOLDS® GRANDSTAND™ 54 OZ. HINGED BOWL - CLEAR BASE.....	111
13173	REYNOLDS® 30 OZ. OCTAGONAL CLAMSHELL.....	121
13223	REYNOLDS® 8/8/8/4 OZ. 4 COMPARTMENT OCTAGONAL CLAMSHELL.....	121
13625	CATERTIME® LOCKFRESH™ 24 OZ. COMBO SALAD BOWL-BLACK/CLEAR.....	111
13626	CATERTIME® LOCKFRESH™ 35 OZ. COMBO SALAD BOWL-BLACK/CLEAR.....	111
13630	CATERTIME® LOCKFRESH™ 35 OZ. COMBO SALAD BOWL-CLEAR/CLEAR.....	111
13631	CATERTIME® LOCKFRESH™ 24 OZ. COMBO SALAD BOWL-CLEAR/CLEAR.....	111
2155P300	REYNOLDS® SQUARE HINGED BAR-LOCK.....	19
2170P200	REYNOLDS® LARGE SQUARE HINGED BAR-LOCK.....	19
2175	REYNOLDS® SMALL DANISH HINGED BAR-LOCK.....	19
2221	REYNOLDS® 5" SQUARE HINGED BAR-LOCK.....	19
527-30	7" ALUMINUM ROUND - 1 1/2" LBS.....	13
527WP	7" ALUMINUM ROUND AND DOME.....	13
558TPZ	8" ROUND AND BOARD COVER.....	13
57310-30	10" ALUMINUM ROUND.....	13
94119	THE SELL OUT LARGE SUPER DEEP HINGEWARE.....	19
C18-1030	SMARTLOCK® CLEAR MEDIUM HINGED LID CONTAINER - DEEP.....	19
DP10874	DOPACO 7" PIZZA CLAMSHELL W/WINDOW & PAD.....	119
DP13881	DOPACO MEDIUM BASKETWEAVE BARN BOX.....	115
DP14010	DOPACO LARGE BASKETWEAVE BARN BOX.....	115
DP14068	DOPACO 14/8 PIZZA CLAMSHELL - WHITE.....	117
DP14200	DOPACO 8 OZ. WHITE CONTAINERS W/LIDS.....	115
DP14201	DOPACO 12 OZ. WHITE CONTAINERS W/LIDS.....	115
DP14351	DOPACO 5 OZ. FINGER FOOD SCOOP.....	117
DP14360	DOPACO 3 OZ. FINGER FOOD SCOOP.....	117
DP14362	DOPACO 16 OZ. WHITE CONTAINERS W/LIDS.....	115
DP14389	DOPACO 6 OZ. FINGER FOOD SCOOP.....	117
DP14390	DOPACO 7 OZ. FINGER FOOD SCOOP.....	117
DP14756	DOPACO 10 LB. BASKETWEAVE STOCK FOOD TRAY.....	115
DP15459	DOPACO 12 OZ. WHITE CONTAINER.....	115
DP15460	DOPACO 16 OZ. WHITE CONTAINER.....	115
DP15561	DOPACO 8/12/16 OZ. WHITE PLASTIC LID.....	115
DP15583	DOPACO 8" PIZZA CLAMSHELL W/PAD - FRESH HOT.....	119
DP15686	DOPACO 8 OZ. WHITE CONTAINER.....	115
DP18263	DOPACO 8 OZ. FRESH DELICIOUS CONTAINERS W/LIDS.....	115
DP18264	DOPACO 12 OZ. FRESH DELICIOUS CONTAINER.....	115
DP18266	DOPACO 12 OZ. FRESH DELICIOUS CONTAINERS W/LIDS.....	115
DP18267	DOPACO 16 OZ. FRESH DELICIOUS CONTAINERS W/LIDS.....	115
DP18268	DOPACO 16 OZ. FRESH DELICIOUS CONTAINER.....	115
DP1870	DOPACO 16/8 PIZZA CLAMSHELL - WHITE.....	117
DP18934	DOPACO 32 OZ. WHITE PLASTIC CONTAINER LID.....	115
DP19323	DOPACO HOT DOG HOLDER W/PERFORATION.....	117
DP1969	DOPACO 7" PIZZA CLAMSHELL W/PAD.....	119
DP20636	DOPACO 32 OZ. WHITE CONTAINER - KRAFT.....	115
DP20746	DOPACO 2 LB. BASKETWEAVE E TRAY.....	117
DP20773	DOPACO 8 OZ. BASKETWEAVE E TRAY.....	117
DP20775	DOPACO 4 OZ. BASKETWEAVE E TRAY.....	117
DP20777	DOPACO 6 OZ. BASKETWEAVE E TRAY.....	117
DP20778	DOPACO 3 LB. BASKETWEAVE E TRAY.....	117
DP20779	DOPACO 5 LB. BASKETWEAVE E TRAY.....	117
DP20780	DOPACO 1 LB. BASKETWEAVE E TRAY.....	117

Product Number	Description	Page
DP3703	DOPACO 18/6 PIZZA CLAMSHELL - WHITE.....	117
DP3753	DOPACO BASKETWEAVE DINNER BOX.....	115
DP3842	DOPACO WHITE DINNER BOX.....	115
DP4010	DOPACO 3 LB. POCKET TRAY - WHITE.....	117
DP4200	DOPACO 3.5 OZ. REGULAR FRY - WHITE.....	117
DP4201	DOPACO 5 OZ. LARGE FRY - WHITE.....	117
DP4211	DOPACO 6 OZ. JUMBO FRY - WHITE.....	117
DP4220	DOPACO 7 OZ. SUPER SIZE FRY - WHITE.....	117
DP4440	DOPACO 6" PIZZA CLAMSHELL W/PAD - WHITE.....	119
DP4991	DOPACO 9" PIZZA CLAMSHELL W/PAD - KRAFT.....	119
DP5012	DOPACO CALZONE CLAMSHELL - KRAFT.....	119
DP5580	DOPACO REGULAR WHITE HOT DOG TRAY.....	117
DP5590	DOPACO #25 4 OZ. BASKETWEAVE STOCK FOOD TRAY.....	115
DP5877	DOPACO REGULAR BASKETWEAVE HOT DOG TRAY.....	117
DP5802	DOPACO #40 6 OZ. BASKETWEAVE STOCK FOOD TRAY.....	115
DP5803	DOPACO #40 8 OZ. BASKETWEAVE STOCK FOOD TRAY.....	115
DP5804	DOPACO #100 1 LB. BASKETWEAVE STOCK FOOD TRAY.....	115
DP5811	DOPACO 5" HAMBURGER CLAMSHELL.....	115
DP5813	DOPACO #250 2.5 LB. BASKETWEAVE STOCK FOOD TRAY.....	115
DP5814	DOPACO #200 2 LB. BASKETWEAVE STOCK FOOD TRAY.....	115
DP5815	DOPACO #300 3 LB. BASKETWEAVE STOCK FOOD TRAY.....	115
DP5817	DOPACO #500 5 LB. BASKETWEAVE STOCK FOOD TRAY.....	115
DP6151	DOPACO 2.5 OZ. JUNIOR FRY - BASKETWEAVE.....	117
DP6152	DOPACO 3.5 OZ. REGULAR FRY - BASKETWEAVE.....	117
DP6153	DOPACO 5 OZ. LARGE FRY - BASKETWEAVE.....	117
DP6154	DOPACO 6 OZ. JUMBO FRY - BASKETWEAVE.....	117
DP6751	DOPACO BASKETWEAVE SNACK BOX.....	115
DP6977	DOPACO 18/6 PIZZA CLAMSHELL - FRESH HOT.....	119
DP7649	DOPACO REGULAR WHITE HOT DOG TRAY.....	117
DP7651	DOPACO 10 LB. WHITE SCHOOL TRAY.....	115
DP7654	DOPACO BARREL SCHOOL TRAY.....	115
DP7854	DOPACO SUPER HOT DOG HOLDER.....	117
DP7857	DOPACO REGULAR SLICE TRAY.....	119
DP7873	DOPACO 2.5 OZ. JUNIOR FRY - WHITE.....	117
DP7931	DOPACO REGULAR HOT DOG CLAMSHELL.....	115
DP7936	DOPACO LARGE HOT DOG CLAMSHELL.....	115
DP7964	DOPACO WHITE SNACK BOX.....	115
DP8163	DOPACO LARGE WHITE DINNER BOX.....	115
DP8768	DOPACO 6" PIZZA CLAMSHELL W/PAD - FRESH HOT.....	119
DP8788	DOPACO 16/8 PIZZA CLAMSHELL - FRESH HOT.....	119
DP9167	DOPACO 7" PIZZA CLAMSHELL W/PAD - WHITE.....	117
EH8-9602	SMALL DUAL COLOR SNACK BOX.....	17
EH8-9622	MEDIUM DUAL COLOR SNACK BOX (DEEP).....	17
HLW-V801	SMARTLOCK® MEDIUM WHITE 1-CMPT VENTED CONTAINER.....	15
HLW-V803	SMARTLOCK® MEDIUM WHITE 3-CMPT VENTED CONTAINER.....	15
HLW-V901	SMARTLOCK® LARGE WHITE 1-CMPT VENTED CONTAINER.....	15
HLW-V903	SMARTLOCK® LARGE WHITE 3-CMPT VENTED CONTAINER.....	15
L527	FOIL LAMINATED BOARD COVER FOR 7" ROUND.....	13
L558	FOIL LAMINATED BOARD COVER FOR 8" ROUND.....	13
NC-333	12 OZ NEWSRING® VERSATAINER® 3 CMPT WHITE RECT BASE & CLEAR LID.....	113
NC-333-B	12 OZ NEWSRING® VERSATAINER® 3 CMPT BLACK RECT BASE & CLEAR LID.....	113
NC-626	26 OZ NEWSRING® VERSATAINER® WHITE SQUARE BASE & CLEAR LID.....	113
NC-626-B	26 OZ NEWSRING® VERSATAINER® BLACK SQUARE BASE & CLEAR LID.....	113
NC-636	36 OZ NEWSRING® VERSATAINER® WHITE SQUARE BASE & CLEAR LID.....	113
NC-636-B	36 OZ NEWSRING® VERSATAINER® BLACK SQUARE BASE & CLEAR LID.....	113
NC-718	16 OZ NEWSRING® VERSATAINER® WHITE ROUND BASE & CLEAR LID.....	113
NC-718-B	16 OZ NEWSRING® VERSATAINER® BLACK ROUND BASE & CLEAR LID.....	113
NC-723	24 OZ NEWSRING® VERSATAINER® WHITE ROUND BASE & CLEAR LID.....	113
NC-723-B	24 OZ NEWSRING® VERSATAINER® BLACK ROUND BASE & CLEAR LID.....	113
NC-729	32 OZ NEWSRING® VERSATAINER® WHITE ROUND BASE & CLEAR LID.....	113
NC-729-B	32 OZ NEWSRING® VERSATAINER® BLACK ROUND BASE & CLEAR LID.....	113
NC-737	35 OZ NEWSRING® VERSATAINER® WHITE ROUND BASE & CLEAR LID.....	113
NC-737-B	35 OZ NEWSRING® VERSATAINER® BLACK ROUND BASE & CLEAR LID.....	113
NC-8168	16 OZ NEWSRING® VERSATAINER® WHITE RECT BASE & CLEAR LID.....	113
NC-8168-B	16 OZ NEWSRING® VERSATAINER® BLACK RECT BASE & CLEAR LID.....	113
NC-8168-BV	16 OZ NEWSRING® VERSATAINER® BLACK RECT BASE & VENTED CLEAR LID.....	113
NC-818	12 OZ NEWSRING® VERSATAINER® WHITE RECT BASE & CLEAR LID.....	113
NC-818-B	12 OZ NEWSRING® VERSATAINER® BLACK RECT BASE & CLEAR LID.....	113
NC-8288	30 OZ NEWSRING® VERSATAINER® 2 CMPT WHITE RECT BASE & CLEAR LID.....	113
NC-8288-B	30 OZ NEWSRING® VERSATAINER® 2 CMPT BLACK RECT BASE & CLEAR LID.....	113
NC-838	24 OZ NEWSRING® VERSATAINER® WHITE RECT BASE & CLEAR LID.....	113
NC-838-B	24 OZ NEWSRING® VERSATAINER® BLACK RECT BASE & CLEAR LID.....	113
NC-838-BV	24 OZ NEWSRING® VERSATAINER® BLACK RECT BASE & VENTED CLEAR LID.....	113
NC-868	28 OZ NEWSRING® VERSATAINER® WHITE RECT BASE & CLEAR LID.....	113
NC-868-B	28 OZ NEWSRING® VERSATAINER® BLACK RECT BASE & CLEAR LID.....	113
NC-888	38 OZ NEWSRING® VERSATAINER® WHITE RECT BASE & CLEAR LID.....	113
NC-888-B	38 OZ NEWSRING® VERSATAINER® BLACK RECT BASE & CLEAR LID.....	113
NC-888-BV	38 OZ NEWSRING® VERSATAINER® BLACK RECT BASE & CLEAR LID - VENTED.....	113
NC-9388	48 OZ NEWSRING® VERSATAINER® 3 CMPT WHITE ROUND BASE & CLEAR LID.....	113
NC-9388-B	48 OZ NEWSRING® VERSATAINER® 3 CMPT BLACK ROUND BASE & CLEAR LID.....	113
NC-948	48 OZ NEWSRING® VERSATAINER® WHITE ROUND BASE & CLEAR LID.....	113
NC-948-B	48 OZ NEWSRING® VERSATAINER® BLACK ROUND BASE & CLEAR LID.....	113
NC-948-BV	48 OZ NEWSRING® VERSATAINER® BLACK ROUND BASE & VENTED CLEAR LID.....	113
NC-989	58 OZ NEWSRING® VERSATAINER® WHITE RECT BASE & CLEAR LID.....	113
NC-989-B	58 OZ NEWSRING® VERSATAINER® BLACK RECT BASE & CLEAR LID.....	113
NC-989-BV	58 OZ NEWSRING® VERSATAINER® BLACK RECT BASE & CLEAR LID - VENTED.....	113
OC-06	6 OZ NEWSRING® VERSATAINER® WHITE OVAL BASE & CLEAR LID.....	111
OC-06-B	6 OZ NEWSRING® VERSATAINER® BLACK OVAL BASE & CLEAR LID.....	111
OC-08	8 OZ NEWSRING® VERSATAINER® WHITE OVAL BASE & CLEAR LID.....	111
OC-08-B	8 OZ NEWSRING® VERSATAINER® BLACK OVAL BASE & CLEAR LID.....	111
OC-12	12 OZ NEWSRING® VERSATAINER® WHITE OVAL BASE & CLEAR LID.....	111
OC-12-B	12 OZ NEWSRING® VERSATAINER® BLACK OVAL BASE & CLEAR LID.....	111

Product Number	Description	Page
OC-16	16 OZ NEWSPRING® VERSATAINER® WHITE OVAL BASE & CLEAR LID.....	111
OC-16-B	16 OZ NEWSPRING® VERSATAINER® BLACK OVAL BASE & CLEAR LID.....	111
OC-24	24 OZ NEWSPRING® VERSATAINER® WHITE OVAL BASE & CLEAR LID.....	111
OC-24-B	24 OZ NEWSPRING® VERSATAINER® BLACK OVAL BASE & CLEAR LID.....	111
OC-32	32 OZ NEWSPRING® VERSATAINER® WHITE OVAL BASE & CLEAR LID.....	111
OC-32-B	32 OZ NEWSPRING® VERSATAINER® BLACK OVAL BASE & CLEAR LID.....	111
SAB0508	8 OZ. BLACK SQUARE BOWL BASE.....	17
SAB0512	12 OZ. BLACK SQUARE BOWL BASE.....	17
SAB0516	16 OZ. BLACK SQUARE BOWL BASE.....	17
SAB0724	24 OZ. BLACK SQUARE BOWL BASE.....	17
SAB0732	32 OZ. BLACK SQUARE BOWL BASE.....	17
SAB0948	48 OZ. BLACK SQUARE BOWL BASE.....	17
SAB0964	64 OZ. BLACK SQUARE BOWL BASE.....	17
SAC0508	8 OZ. CLEAR SQUARE BOWL BASE.....	17
SAC0512	12 OZ. CLEAR SQUARE BOWL BASE.....	17
SAC0516	16 OZ. CLEAR SQUARE BOWL BASE.....	17
SAC0724	24 OZ. CLEAR SQUARE BOWL BASE.....	17
SAC0732	32 OZ. CLEAR SQUARE BOWL BASE.....	17
SAC0948	48 OZ. CLEAR SQUARE BOWL BASE.....	17
SAC0964	64 OZ. CLEAR SQUARE BOWL BASE.....	17
SACLD07	24, 32 OZ. CLEAR DOME LID.....	17
SACLD09	48, 64 OZ. CLEAR DOME LID.....	17
SACLF07	24, 32 OZ. CLEAR FLAT LID.....	17
SACLF09	48, 64 OZ. CLEAR FLAT LID.....	17
SACLI07T	7.375" INSERT FOR SQUARE SALAD CONTAINERS.....	17
SACLI09T	9" INSERT FOR SQUARE SALAD CONTAINERS.....	17
TH1-0099	WHITE LARGE RECTANGULAR DEEP CONTAINER.....	13
TH1-X266	WHITE 13" HOAGIE CONTAINER.....	13
Y509-30	9" ROUND.....	13
Y527-25	7" ALUMINUM ROUND - 1 1/2 LBS.....	13
Y558-30	8" ALUMINUM ROUND.....	13
Y80215	DL WHITE MED. 3 COMPARTMENT HINGED LID CONTAINER (SHALLOW).....	15
Y80561	DL WHITE MED. 1 COMPARTMENT HINGED LID CONTAINER (SHALLOW).....	15
Y80581	DL WHITE LARGE 1 COMPARTMENT HINGED LID CONTAINER.....	15
Y80583	DL WHITE LARGE 3 COMPARTMENT HINGED LID CONTAINER.....	15
Y80661	DL WHITE MEDIUM 1 COMPARTMENT HINGED LID CONTAINER.....	15
Y80661CE01100	DL WHITE MEDIUM 1 CMPT. HINGED LID CONT. (ORIENTAL EMBOSSING).....	15
Y80663	DL WHITE MEDIUM 3 COMPARTMENT HINGED LID CONTAINER.....	15
Y80663CE00200	DL WHITE MEDIUM 3 CMPT. HINGED LID CONT. (ORIENTAL EMBOSSING).....	15
Y94111	THE SELL OUT LARGE NON-CMPT. DEEP HINGEWARE.....	19
Y94121	THE SELL OUT MEDIUM NON-CMPT. DEEP HINGEWARE.....	19
Y94130	THE SELL OUT MED. NON-CMPT. HINGEWARE.....	19
Y95200W	CLEARVIEW™ WHITE ENTREE PLATTER.....	19
Y95900K	CLEARVIEW™ BLACK ENTREE PLATTER.....	19
Y95970K	CLEARVIEW™ BLACK SHALLOW MEDIUM PLATTER.....	19
Y95980K	CLEARVIEW™ BLACK DEEP MEDIUM PLATTER.....	19
Y96100KEP	CLEARVIEW™ LARGE BLACK PLATTER W/DOME.....	19
Y96180KPP	CLEARVIEW™ MEDIUM BLACK PLATTER W/DOME.....	19
Y96180PP	CLEARVIEW™ MEDIUM CLEAR PLATTER W/DOME.....	19
YCA910480000	48 OZ. CLEAR HINGED CONTAINER - RPET.....	119
YCA910640000	64 OZ. CLEAR HINGED CONTAINER - RPET.....	119
YCASH1050	APET CLEAR 5" HINGED LID W/1 CMPT. TRAY.....	111
YCASH1160	APET CLEAR 6" HINGED LID W/1 CMPT. TRAY.....	111
YC18-0960	SMARTLOCK® FOOT-LONG HINGEWARE.....	19
YC18-1045	SMARTLOCK® SMARTLOCK® SINGLE TAB HOTDOG CONTAINER.....	19
YC18-1048	SMARTLOCK® CLEAR 7 1/2" SLIM BIN PACKAGE.....	19
YC18-1049	SMARTLOCK® CLEAR 9" SLIM BIN PACKAGE.....	19
YC18-1050	SMARTLOCK® CLEAR 5" SMARTLOCK® HINGED LID W/1-CMPT. TRAY.....	19
YC18-1110	SMARTLOCK® CLEAR LARGE HINGED LID W/1-CMPT. TRAY.....	19
YC18-1113	SMARTLOCK® CLEAR LARGE HINGED LID W/3-CMPT. TRAY.....	19
YC18-1120	SMARTLOCK® CLEAR MEDIUM HINGED LID W/1-CMPT. TRAY.....	19
YC18-1123	SMARTLOCK® CLEAR MEDIUM HINGED LID W/3-CMPT. TRAY.....	19
YC18-1160	SMARTLOCK® CLEAR 6" HINGED LID W/1-CMPT. TRAY.....	19
YC18-2025	SMARTLOCK® CLEAR SMALL HINGED LID.....	19
YC18-2030	SMARTLOCK® CLEAR HINGED LID W/1-CMPT. TRAY (SS).....	19
YC18-2035	SMARTLOCK® CLEAR HINGED LID W/1-CMPT. TRAY (DS).....	19
YC18-2040	SMARTLOCK® CLEAR HINGED LID W/1-CMPT. TRAY (DD).....	19
YC18-3035	SMARTLOCK® CLEAR UTILITY (DS).....	19
YC18-8062	CLEARVIEW™ 2-CMPT. NACHO TRAY.....	19
YC18-8063	CLEARVIEW™ 1-CMPT. TRAY W/LID - COMBO PACK.....	19
YC18-8068	CLEARVIEW™ LARGE 2-CMPT. NACHO TRAY.....	19
YCN8-0600	16 OZ. 1 CMPT. SMARTLOCK® EARTHCHOICE HINGED SANDWICH CONT.....	15
YCN8-0801	1 CMPT. MED. SMARTLOCK® EARTHCHOICE HINGED CONT.....	15
YCN8-0803	3 CMPT. MED. SMARTLOCK® EARTHCHOICE HINGED CONT.....	15
YCN8-0901	1 CMPT. LARGE SMARTLOCK® EARTHCHOICE HINGED CONT.....	15
YCN8-0903	3 CMPT. LARGE SMARTLOCK® EARTHCHOICE HINGED CONT.....	15
YCN8-0961	1 CMPT. SMARTLOCK® EARTHCHOICE HINGED HOAGIE CONT.....	15
YCN8-0962	2 CMPT. SMARTLOCK® EARTHCHOICE HINGED HOAGIE CONT.....	15
YEH8-9090	CLEARVIEW™ SMARTLOCK® HEXWARE™ 9" HINGED CONT. (SHALLOW).....	17
YEH8-9093	CLEARVIEW™ SMARTLOCK® HEXWARE™ 9" 3-CMPT. HINGED CONT. (SHALLOW).....	17
YEH8-9111	1 COMPARTMENT DUAL COLOR CONTAINER.....	17
YEH8-9112	2 COMPARTMENT DUAL COLOR CONTAINER.....	17
YEH8-9113	3 COMPARTMENT DUAL COLOR CONTAINER.....	17
YEH8-9114	4 COMPARTMENT DUAL COLOR CONTAINER.....	17
YEH8-9148	SMALL DUAL COLOR HOAGIE CONTAINER.....	17
YEH8-9150	CLEARVIEW™ SMARTLOCK® HEXWARE™ DUAL COLOR 5" HINGED LID CONT.....	17
YEH8-9160	CLEARVIEW™ SMARTLOCK® HEXWARE™ DUAL COLOR 6" HINGED LID CONT.....	17
YEH8-9170	CLEARVIEW™ SMARTLOCK® HEXWARE™ DUAL COLOR 7" HINGED LID CONT.....	17
YEH8-9190	CLEARVIEW™ SMARTLOCK® HEXWARE™ DUAL COLOR 9" HINGED LID CONT.....	17
YEH8-9193	CLEARVIEW™ SMARTLOCK® HEXWARE™ DUAL COLOR 9" 3 CMPT. HINGED CONT.....	17
YEH8-9612	MEDIUM DUAL COLOR SNACK BOX (SHALLOW).....	17
YEH8-9617	LARGE DUAL COLOR SNACK BOX.....	17

Product Number	Description	Page
YHD1-8550	SUPER SHALLOW 1-CMPT FOAM HINGED LID CONTAINER.....	13
YHD3-8550	SUPER SHALLOW 3-CMPT FOAM HINGED LID CONTAINER.....	13
YHLB-0600	SMARTLOCK® MEDIUM BLACK SQUARE SANDWICH CONTAINER.....	15
YHLB-0801	SMARTLOCK® MEDIUM BLACK SINGLE CMPT CONTAINER.....	15
YHLB-0803	SMARTLOCK® MEDIUM BLACK 3-CMPT CONTAINER.....	15
YHLB-0901	SMARTLOCK® LARGE BLACK SINGLE CMPT CONTAINER.....	15
YHLB-0903	SMARTLOCK® LARGE BLACK 3-CMPT CONTAINER.....	15
YHLB-V901	SMARTLOCK® LARGE BLACK 1-CMPT VENTED CONTAINER.....	15
YHLB-V903	SMARTLOCK® LARGE BLACK 3-CMPT VENTED CONTAINER.....	15
YHLW-0184	SMARTLOCK® MEDIUM SANDWICH CONTAINER.....	15
YHLW-0185	SMARTLOCK® LARGE SANDWICH CONTAINER.....	15
YHLW-0188	SMARTLOCK® MEDIUM CARRY-OUT CONTAINER.....	15
YHLW-0189	SMARTLOCK® LARGE CARRY-OUT CONTAINER.....	15
YHLW-0600	SMARTLOCK® MEDIUM WHITE SQUARE SANDWICH CONTAINER.....	15
YHLW-0701	SMARTLOCK® SMALL WHITE SINGLE CMPT CONTAINER.....	15
YHLW-0703	SMARTLOCK® SMALL WHITE 3 CMPT CONTAINER.....	15
YHLW-0801	SMARTLOCK® MEDIUM WHITE SINGLE CMPT CONTAINER.....	15
YHLW-0803	SMARTLOCK® MEDIUM WHITE 3-CMPT CONTAINER.....	15
YHLW-0901	SMARTLOCK® LARGE WHITE SINGLE CMPT CONTAINER.....	15
YHLW-0903	SMARTLOCK® LARGE WHITE 3-CMPT CONTAINER.....	15
YHLW-1001	SMARTLOCK® X-LARGE WHITE SINGLE CMPT CONTAINER.....	15
YHLW-1003	SMARTLOCK® X-LARGE WHITE 3-CMPT CONTAINER.....	15
YL509	FOIL LAMINATED BOARD COVER FOR 9" ROUND.....	13
YL1811200000	EARTHCHOICE® MEDIUM 1-CMPT. PLA CLEAR HINGED LID CONTAINER.....	119
YL1811230000	EARTHCHOICE® MEDIUM 3-CMPT. PLA CLEAR HINGED LID CONTAINER.....	119
YL1811600000	6" EARTHCHOICE® PLA CLEAR HINGED LID CONTAINER.....	119
YL1860080000	8 OZ. EARTHCHOICE® PLA CLEAR DELI CONTAINER W/LID.....	119
YL1860160000	16 OZ. EARTHCHOICE® PLA CLEAR DELI CONTAINER W/LID.....	119
YL1860240000	24 OZ. EARTHCHOICE® PLA CLEAR DELI CONTAINER W/LID.....	119
YL1860320000	32 OZ. EARTHCHOICE® PLA CLEAR DELI CONTAINER W/LID.....	119
YLSPLA-2	2 OZ. EARTHCHOICE® PLA CLEAR PORTION CUP LID.....	119
YLSPLA-3	3.25 & 4 OZ. EARTHCHOICE® PLA CLEAR PORTION CUP LID.....	119
YMFH-0080	EARTHCHOICE® FIBER BLEND 1-CMPT HINGE LID SANDWICH CONTAINER.....	13
YMFH-0089	EARTHCHOICE® FIBER BLEND 1-CMPT HINGE LID UTILITY CONTAINER.....	13
YMFH-0801	EARTHCHOICE® FIBER BLEND 1-CMPT MEDIUM 1-CMPT HINGE LID CONTAINER.....	13
YMFH-0803	EARTHCHOICE® FIBER BLEND MEDIUM 3-CMPT HINGE LID CONTAINER.....	13
YMFH-0901	EARTHCHOICE® FIBER BLEND LARGE 1-CMPT HINGE LID CONTAINER.....	13
YMFH-0903	EARTHCHOICE® FIBER BLEND LARGE 3-CMPT HINGE LID CONTAINER.....	13
YP509S	SHALLOW PLASTIC DOME FOR 9" ROUND.....	13
Y509TP	9" ALUMINUM ROUND AND BOARD COVER.....	13
YP527	PLASTIC DOME FOR 7" ROUND.....	13
Y527TP	7" ALUMINUM ROUND AND BOARD COVER.....	13
YP95107	CLEARVIEW™ CLEAR SHALLOW MEDIUM PLATTER DOME.....	19
YP95108	CLEARVIEW™ CLEAR DEEP ENTREE PLATTER DOME.....	19
YP95109	CLEARVIEW™ CLEAR DEEP MEDIUM PLATTER DOME.....	19
YP558	PLASTIC DOME FOR 8" ALUM ROUND.....	13
YSACLD05	8, 12, 16 OZ. CLEAR DOME LID.....	17
YSACLF05	8, 12, 16 OZ. CLEAR FLAT LID.....	17
YSLA2000EC	2 OZ. EARTHCHOICE® PRINTED PLA CLEAR PORTION CUP.....	119
YSLA3000EC	3.25 OZ. EARTHCHOICE® PRINTED PLA CLEAR PORTION CUP.....	119
YSLA4000EC	4 OZ. EARTHCHOICE® PRINTED PLA CLEAR PORTION CUP.....	119
YTD18801	WHITE MEDIUM 1-CMPT. DUAL TAB CONVENTIONAL CONTAINER.....	13
YTD18803	WHITE MEDIUM 3-CMPT. DUAL TAB CONVENTIONAL CONTAINER.....	13
YTD-9901	WHITE LARGE 1-CMPT. DUAL TAB CONVENTIONAL CONTAINER.....	13
YTD19901	WHITE LARGE 1-CMPT. DUAL TAB CONVENTIONAL CONTAINER.....	13
YTD19901MUGR	WHITE LARGE 1-CMPT. DUAL TAB CONT - MUCHAS GRACIAS EMBOSS.....	13
YTD19903	WHITE LARGE 3-CMPT. DUAL TAB CONVENTIONAL CONTAINER.....	13
YTD19903MUGR	WHITE LARGE 3-CMPT. DUAL TAB CONT - MUCHAS GRACIAS EMBOSS.....	13
YTH10079	WHITE SMALL SQUARE SANDWICH CONTAINER.....	13
YTH10080	WHITE MEDIUM SQUARE SANDWICH CONTAINER.....	13
YTH10081	WHITE LARGE SQUARE SANDWICH CONTAINER.....	13
YTH-0089	WHITE LARGE RECTANGULAR DEEP CONTAINER.....	13
YTH10098	WHITE SMALL RECTANGULAR SANDWICH CONTAINER.....	13
YTH10205	WHITE LARGE RECTANGULAR DEEP CONTAINER.....	13
YTH10205	WHITE LARGE RECTANGULAR DEEP CONTAINER.....	13
YTH10205THYU	WHITE 9" X 6" UTILITY TRAY - HAPPY FACE EMBOSS.....	13
YTH10206	WHITE LARGE RECTANGULAR SHALLOW CONTAINER.....	13
YTH10206THYU	WHITE 9" X 6" UTILITY TRAY SHALLOW - HAPPY FACE EMBOSS.....	13
YTH10207	WHITE LARGE RECTANGULAR LOW PROFILE CONTAINER.....	13
YTXB-0600	PREMIER® BLACK LARGE SANDWICH FOAM HINGED CONTAINER.....	15
YTXB-0801	PREMIER® BLACK MEDIUM 1-COMPARTMENT FOAM HINGED CONTAINER.....	15
YTXB-0803	PREMIER® BLACK MEDIUM 3-COMPARTMENT FOAM HINGED CONTAINER.....	15
YTXB-0901	PREMIER® BLACK LARGE 1-COMPARTMENT FOAM HINGED CONTAINER.....	15
YTXB-0903	PREMIER® BLACK LARGE 3-COMPARTMENT FOAM HINGED CONTAINER.....	15

**Aluminum Carry-Out — Window-Pack® and Thrift-Pack® Combos**

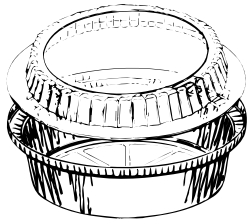

527WP

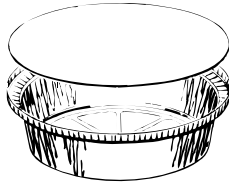

558TPZ

**Aluminum Rounds — Hemmed Edge**

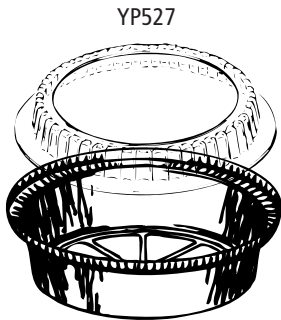

YP527

527-30

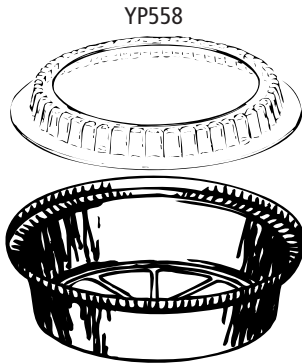

YP558

Y558-30

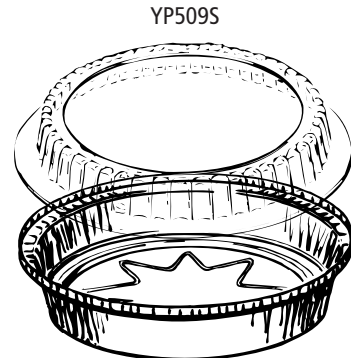

YP509S

Y509-30

**EarthChoice® Fiber Blend Hinge Lid Containers**

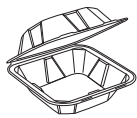

YMFH-0080



YMFH-0089



YMFH-0801

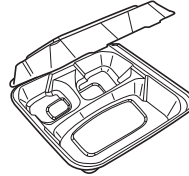

YMFH-0803

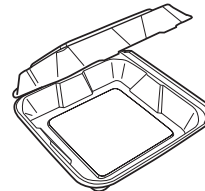

YMFH-0901

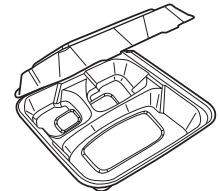

YMFH-0903

**Conventional Foam Hinged Lid Containers**

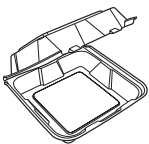

YTD1-8801

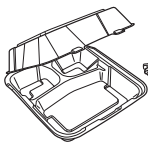

YTD1-8803

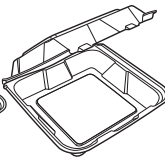

YHD1-8550



YHD3-8550

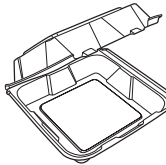

YTD1-9901

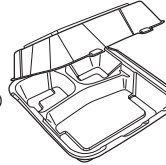

YTD1-9903



YTH1-0079



YTH1-0080



YTH1-0081



YTH1-0098



TH1-0099



YTH1-0089



YTH1-0205



YTH1-0206

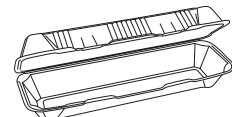

TH1-X266

## Aluminum Carry-Out — Window-Pack® and Thrift-Pack® Combos

Product Number	Container Description	Capacity (fl. oz.)	Dimensions (in inches)	Cover Description	Case		Case Pack	Cases/ Unit Load
					Cube	Weight		
527WP	7" Carry-Out Round Container (527)	24.0	7 1/8 dia. x 1 17/32	Clear Plastic Dome (P527)	2.02	11.00	250	
Y527TP	7" Carry-Out Round Container (527)	24.0	7 1/8 dia. x 1 17/32	Foil Lam. Board Cover (L527)	1.17	8.21	200	45
Y509TP	9" Carry-Out Round Container (509)	46.0	9 dia. x 1 3/4	Foil Lam. Board Cover (L509)	1.80	12.45	175	30
558TPZ	8" Carry-Out Round Container (558)	37.0	8 dia x 1 1/2	Foil Lam. Board Cover (L558)	2.14	7.58	200	

## Aluminum Rounds — Hemmed Edge

Product Number	Description	Capacity (fl. oz.)	Dimensions (in inches)			Vert. Depth	Case Cube	Case Weight	Rim Style	Sleeve	Case Pack	Cases/ Unit Load
			Top	Out	In							
527-30	7" Round - 1 1/2 lb.	24.0	7 1/8	6 9/16	5 9/16	1 17/32	3.12	13.21	H.E.		500	
Y527-25	7" Round - 1 1/2 lb.	24.0	7 1/8	6 9/16	5 9/16	1 17/32	1.21	4.67	H.E.		250	45
L527	Foil-Laminated Board for 527	--	7 3/32	--	--	--	0.29	8.00	H.E.		500	
YP527	Plastic Dome Cover for 527	--	7 1/16	6 3/8	5	1 1/16	1.05	9.79	H.E.	2/250	500	45
Y558-30	8" Round - 2 1/2 lbs.	37.0	8 5/16	7 13/16	7 1/32	1 9/16	1.64	6.98	H.E.		250	30
L558	Foil-Laminated Board Cvr for 558	--	8 1/4	--	--	--	0.34	16.20	H.E.		500	
Y509-30	9" Round - 3 lbs.	46.2	8 15/16	8 3/8	7 25/32	1 21/32	2.66	12.42	H.E.		300	20
YP558	Plastic Dome Cover for 558	--	8 1/4	7.44	--	1 1/16	1.41	11.37		2/250	500	36
YL509	Foil-Laminated Board Cvr for 509	--	8 7/8	--	--	--	0.30	10.18	H.E.		300	160
YP509S	Plastic Shallow Dome for 509	--	8 7/8	8	7 11/16	1 1/16	0.65	9.24	H.E.	1/300	300	80
57310-30	10" Round	67.9	10 1/16	9 7/16	8 21/32	2 7/32	5.04	13.59	H.E.		250	

## EarthChoice® Fiber Blend Hinge Lid Containers

Product Number	Description	Dimensions (in inches)	Cube	Case		Sleeve	Case Pack	Cases/ Unit Load
				Approx. Wt.	Weight			
YMFH-0080	1-Compartment Dual Tab Sandwich Container	5.8 x 5.8 x 3.3	1.52	22.22	2/250	500	32	
YMFH-0089	1-Compartment Dual Tab Utility Container	9.1 x 6.1 x 3.3	.89	10.37	1/150	150	60	
YMFH-0801	Medium 1-Compartment Dual Tab Container	7.8 x 7.8 x 2.8	.90	10.37	1/150	150	60	
YMFH-0803	Medium 3-Compartment Dual Tab Container	7.8 x 7.8 x 2.8	1.04	10.37	1/150	150	54	
YMFH-0901	Large 1-Compartment Dual Tab Container	9 x 9 x 3.5	1.27	22.22	1/150	150	40	
YMFH-0903	Large 3 -Compartment Dual Tab Container	9 x 9 x 3.5	1.45	22.22	1/150	150	30	

## Conventional Foam Hinged Lid Containers

Product Number	Description	Dimension (in inches)	Cube	Case		Packing		Cases/ Unit Load
				Approx. Wt.	Weight	Sleeve	Case	
YTD18801	White Medium 1-Compartment Dual Tab Container	8.4 x 8.2 x 3	2.77	5.60	1/150	150	18	
YTD18803	White Medium 3-Compartment Dual Tab Container	8.4 x 8.2 x 3	2.77	5.82	1/150	150	18	
YHD185S0	Super Shallow 1-Cmpt. Foam Hinged Container	8 x 7 3/4 x 2 1/4	2.09	5.01	1/150	150	30	
YHD385S0	Super Shallow 3-Cmpt. Foam Hinged Container	8 x 7 3/4 x 2 1/4	2.09	5.01	1/150	150	30	
YHD108L10000	Super Shallow Happy Face 1-Cmpt. Foam Hinged Container	8 x 7 3/4 x 2 1/4	2.09	5.01	1/150	150	30	
YHD308L10000	Super Shallow Happy Face 3-Cmpt. Foam Hinged Container	8 x 7 3/4 x 2 1/4	2.09	5.01	1/150	150	30	
YTD19901	White Large 1-Compartment Dual Tab Container	9 x 9.1 x 3.25	2.60	6.77	1/150	150	20	
YTD19901MUGR	White Large 1-Compartment Dual Tab Container - Muchas Gracias Emboss	9 x 9.1 x 3.25	2.60	6.77	1/150	150	20	
YTD19903	White Large 3-Compartment Dual Tab Container	9 x 9.1 x 3.25	2.60	6.80	1/150	150	20	
YTD19903MUGR	White Large 3-Compartment Dual Tab Container - Muchas Gracias Emboss	9 x 9.1 x 3.25	2.60	6.80	1/150	150	20	
YTH10079	White Small Square Sandwich	5 1/8 x 5 1/8 x 2 1/2	3.71	5.32	5/100	500	16	
YTH10080	White Medium Square Sandwich	6 x 6 x 2.5	4.45	8.25	4/125	500	12	
YTH10081	White Large Square Sandwich	6 3/8 x 6 3/8 x 3	3.82	8.67	4/125	500	14	
YTH10098	White Small Rectangular Sandwich	7 1/4 x 3 x 2	4.53	7.20	6/84	504	12	
TH10099Y	White Large Rectangular Deep	9 3/4 x 5 x 3 1/4	5.58	13.50	4/125	500	8	
YTH10089	White Large Rectangular Deep	9 1/8 x 6 1/8 x 3 1/4	3.03	7.65	2/100	200	20	
YTH10205	White Large Rectangular Deep	9 3/16 x 6 1/2 x 2 3/4	2.35	6.78	2/75	150	24	
YTH10205THYU	White 9" x 6" Utility Tray - Happy Face Emboss	9 3/16 x 6 1/2 x 2 3/4	2.35	6.78	2/75	150	24	
YTH10206	White Large Rectangular Shallow	9 3/16 x 6 1/2 x 1 5/8	2.43	6.07	2/75	150	24	
YTH10206THYU	White 9" x 6" Utility Tray Shallow - Happy Face Emboss	9 3/16 x 6 1/2 x 1 5/8	2.43	6.07	2/75	150	24	
YTH10207	White Large Rectangular Low Profile Container	9 3/16 x 6 1/2 x 1.312	2.43	6.02	2/75	150	24	
TH1X266	White 13" Hoagie Container	13 x 4 1/2 x 3	3.67	8.34	2/100	200	12	

## SmartLock® Foam Hinged Lid Containers

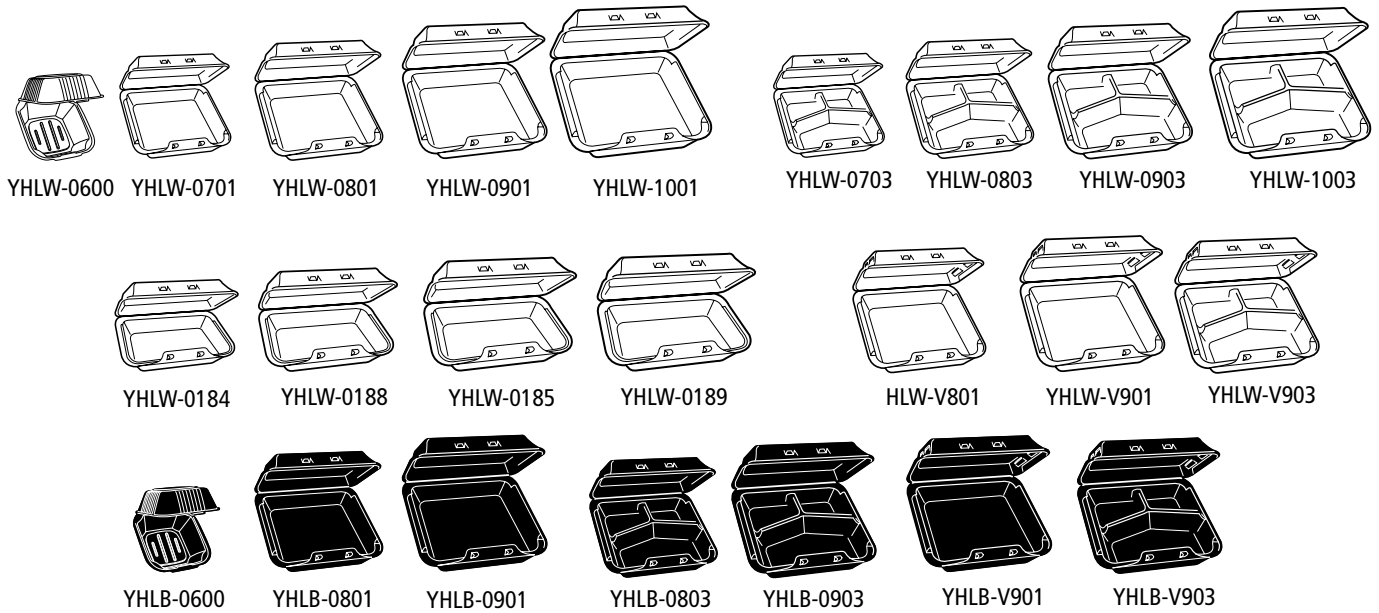

## DL (Double Laminated) Foam Hinged Lid Containers



Oriental  
Embossing  
Design

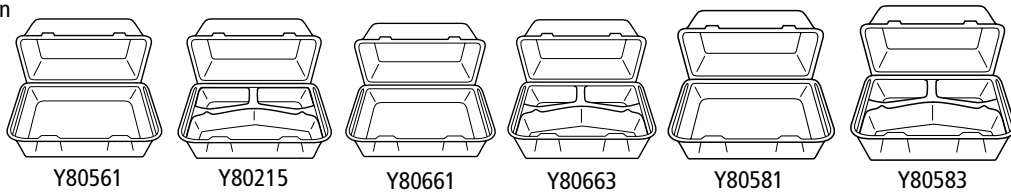

## Premier® Black Foam Hinged Lid Containers

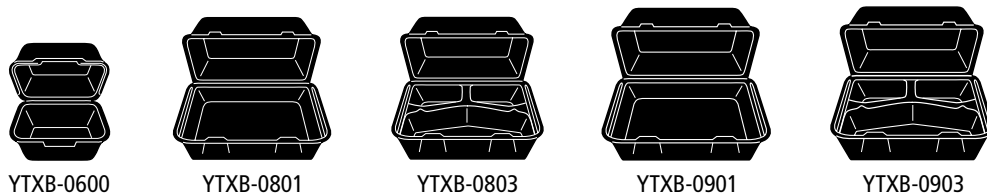

Custom Embossing available on all foam hinge lid containers. Call your Pactiv sales representative for more information.

## EarthChoice® TFPF Hinged Containers

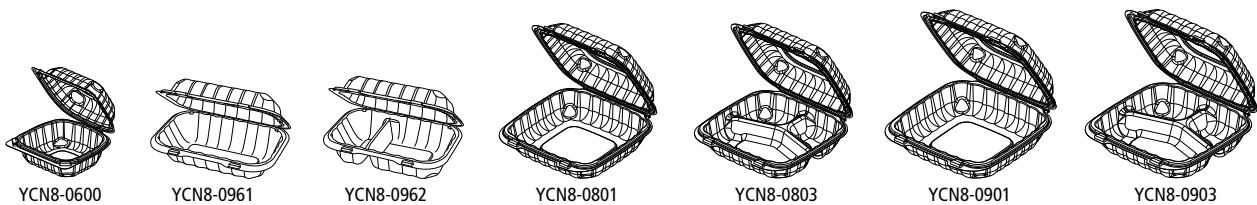

### SmartLock® Foam Hinged Lid Containers

Product Number	Description	Dimension (in inches)	Cube	Case		Packing		Cases/ Unit Load
				Approx Wt.	Sleeve	Case		
YHLW-0600	White Medium Square Sandwich Container	5 3/4 x 5 3/4 x 3 1/4	5.26	9.55	6/84	504	12	
YHLW-0701	White Small Single Compartment Container	7 1/2 x 8 x 2 5/8	2.35	4.95	1/150	150	20	
YHLW-0801	White Medium Single Compartment Container	8 x 8 1/2 x 3	2.57	5.66	1/150	150	20	
YHLW-0901	White Large Single Compartment Container	9 x 9 1/2 x 3 1/4	2.95	6.71	1/150	150	20	
YHLW-1001	White X-Large Single Compartment Container	9 1/2 x 10 1/2 x 3 1/4	6.48	15.14	2/125	250	8	
YHLW-0703	White Small 3-Compartment Container	7 1/2 x 8 x 2 5/8	2.35	4.95	1/150	150	20	
YHLW-0803	White Medium 3-Compartment Container	8 x 8 1/2 x 3	2.57	5.66	1/150	150	20	
YHLW-0903	White Large 3-Compartment Container	9 x 9 1/2 x 3 1/4	2.95	6.71	1/150	150	20	
YHLW-1003	White X-Large 3-Compartment Container	9 1/2 x 10 1/2 x 3 1/4	6.48	15.14	2/125	250	8	
YHLW-0188	White Medium Carry-Out Container	8 3/4 x 5 1/2 x 3	3.49	7.10	2/110	220	16	
YHLW-0189	White Large Carry-Out Container	9 5/16 x 6 3/16 x 3 1/4	3.93	8.86	2/110	220	12	
YHLW-0184	White Medium Rectangular Sandwich Container	8 3/4 x 4 1/2 x 3 1/8	5.22	10.96	4/110	440	12	
YHLW-0185	White Large Rectangular Sandwich Container	9 5/8 x 5 1/8 x 3 1/4	3.67	7.95	2/125	250	16	
HLW-V801	White Medium 1-Compartment Vented Container	8 x 8 1/2 x 3	3.49	7.30	2/100	200	12	
YHLW-V901	White Large 1-Compartment Vented Container	9 x 9 1/2 x 3 1/4	2.95	6.71	1/150	150	20	
YHLW-V903	White Large 3-Compartment Vented Container	9 x 9 1/2 x 3 1/4	2.95	6.71	1/150	150	20	
YHLB-0600	Black Medium Square Sandwich Container	5 3/4 x 5 3/4 x 3 1/4	5.26	9.55	6/84	504	12	
YHLB-0801	Black Medium Single Compartment Container	8 x 8 1/2 x 3	2.57	5.65	1/150	150	20	
YHLB-0901	Black Large Single Compartment Container	9 x 9 1/2 x 3 1/4	2.95	6.71	1/150	150	20	
YHLB-0803	Black Medium 3-Compartment Container	8 x 8 1/2 x 3	2.57	5.65	1/150	150	20	
YHLB-0903	Black Large 3-Compartment Container	9 x 9 1/2 x 3 1/4	2.95	6.71	1/150	150	20	
YHLB-V901	Black Large 1-Compartment Vented Container	9 x 9 1/2 x 3 1/4	2.95	6.71	1/150	150	20	
YHLB-V903	Black Large 3-Compartment Vented Container	9 x 9 1/2 x 3 1/4	2.95	7.97	1/150	150	20	

### DL (Double Laminated) Foam Hinged Lid Containers

Product Number	Description	Dimension (in inches)	Cube	Case		Packing		Cases/ Unit Load
				Approx Wt.	Sleeve	Case		
Y80561	White Medium Single Compartment Container (Shallow)	8 7/16 x 7 7/8 x 2 1/2	2.01	6.42	2/75	150	27	
Y80215	White Medium 3-Compartment Container (Shallow)	8 7/16 x 7 7/8 x 2 1/2	2.01	6.42	2/75	150	27	
Y80661	White Medium Single Compartment Container	8 7/16 x 7 7/8 x 3 1/8	2.18	6.80	2/75	150	27	
Y80661CE01100	White Medium Single Cmp. Container (Oriental Embossing)	8 7/16 x 7 7/8 x 3 1/8	2.18	6.80	2/75	150	27	
Y80663	White Medium 3-Compartment Container	8 7/16 x 7 7/8 x 3 1/8	2.18	6.80	2/75	150	27	
Y80663CE00200	White Medium 3-Compartment Container (Oriental Embossing)	8 7/16 x 7 7/8 x 3 1/8	2.18	6.80	2/75	150	27	
Y80581	White Large Single Compartment Container	9 x 9 x 3 3/8	2.76	8.26	1/150	150	20	
Y80583	White Large 3-Compartment Container	9 x 9 x 3 3/8	2.76	8.26	1/150	150	20	

### Premier® Black Foam Hinged Lid Containers

Product Number	Description	Dimension (in inches)	Cube	Case		Packing		Cases/ Unit Load
				Approx Wt.	Sleeve	Case		
YTXB-0600	Black Large Sandwich Container	5 3/4 x 5 3/4 x 2 3/4	3.50	10.27	4/125	500	16	
YTXB-0801	Black Medium Single Compartment Container	8 7/16 x 7 7/8 x 3 1/8	2.18	6.80	2/75	150	27	
YTXB-0803	Black Medium 3-Compartment Container	8 7/16 x 7 7/8 x 3 1/8	2.18	6.80	2/75	150	27	
YTXB-0901	Black Large Single Compartment Container	9 x 9 x 3 3/8	2.76	8.26	1/150	150	20	
YTXB-0903	Black Large 3-Compartment Container	9 x 9 x 3 3/8	2.76	8.26	1/150	150	20	

Custom Embossing available on all foam hinge lid containers. Call your Pactiv sales representative for more information.

### EarthChoice® TFPF Hinged Containers

Item Number	Description	Capacity (fl. Oz.)	Dimensions (in inches)	Case		Case		Cases/ Unit Load
				Cube	Weight	Sleeve	Pack	
YCN8-0600-0000	1-Cmpt. SmartLock® Sandwich Hinged Container	16	5.75" x 5.95" x 3.10"	3.05	23.53	4/100	400	16
YCN8-0961-0000	1-Cmpt. SmartLock® Hinged Hoagie Container	24	9" x 6" x 3"	3.33	25.01	2/135	270	16
YCN8-0962-0000	2-Cmpt. SmartLock® Hinged Hoagie Container	6/16	9" x 6" x 3"	3.33	25.01	2/135	270	16
YCN8-0801-0000	1-Cmpt. SmartLock® Medium Hinged Container	32	8.35" x 8.35" x 3.1"	2.78	22.59	2/100	200	18
YCN8-0803-0000	3-Cmpt. SmartLock® Medium Hinged Container	4/4/14	8.35" x 8.35" x 3.1"	2.78	22.59	2/100	200	18
YCN8-0901-0000	1-Cmpt. SmartLock® Large Hinged Container	42	9.33" x 8.88" x 3.1"	1.72	16.21	1/120	120	30
YCN8-0903-0000	3-Cmpt. SmartLock® Large Hinged Container	6/6/18	9.33" x 8.88" x 3.1"	1.72	16.21	1/120	120	30

## ClearView™ SmartLock® Dual Color Containers

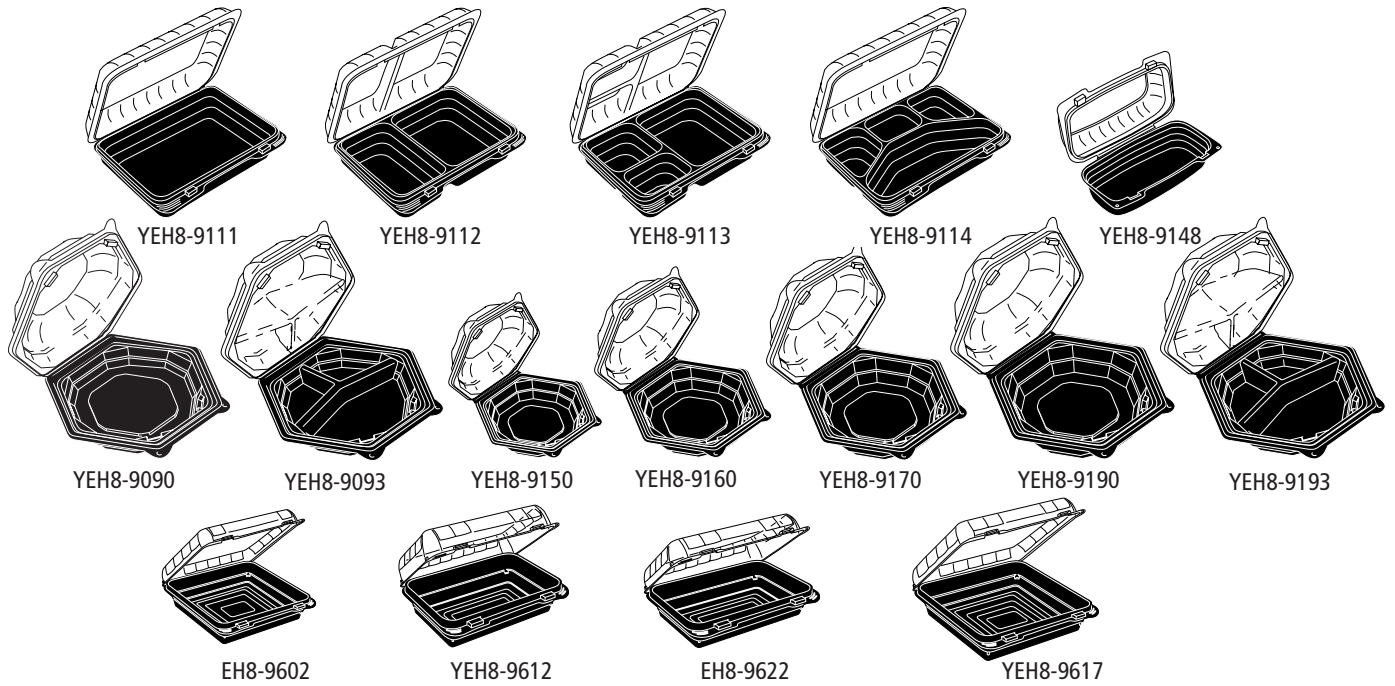

## APET Square Salad Containers

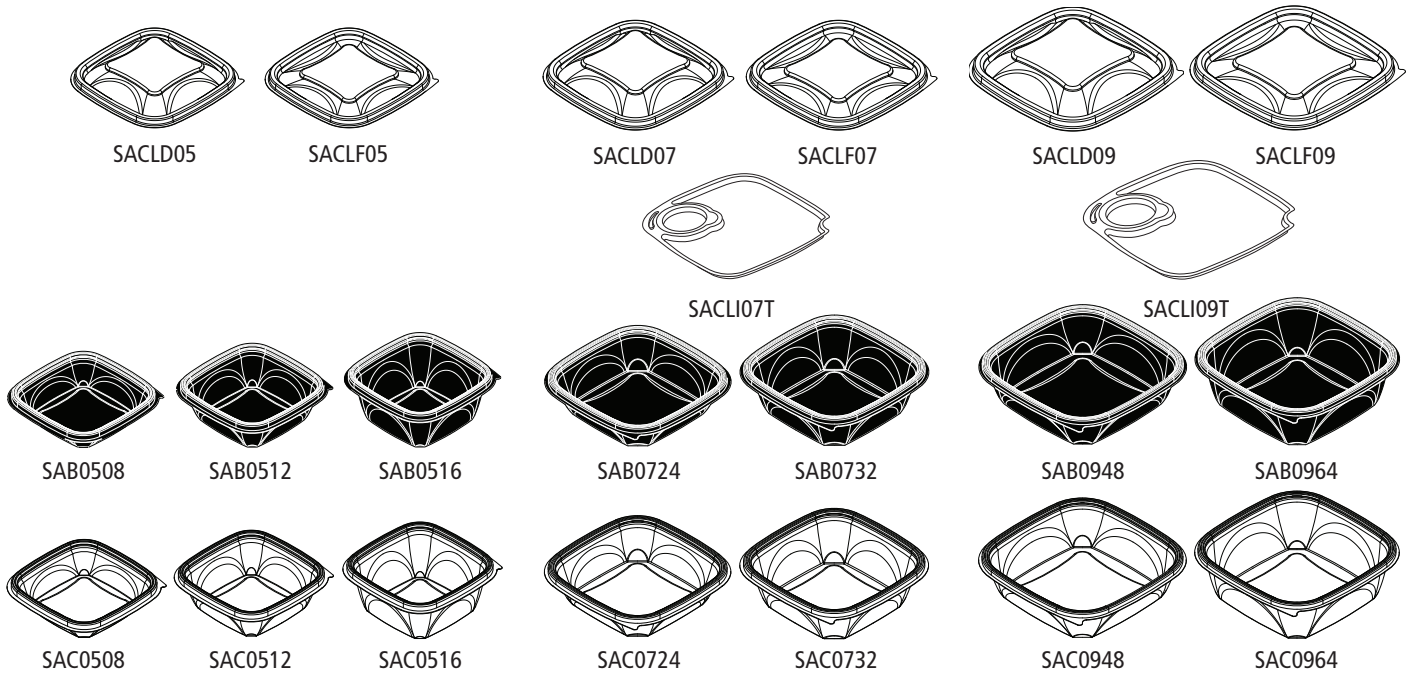



### ClearView™ SmartLock® Dual Color Containers

Product Number	Description	Capacity (fl. oz.)	Dimensions (in inches)	Cube	Case Wt.	Sleeve	Case Pack	Cases/ Unit Load
YEH8-9111	1-Compartment Dual Color Container	45	10 3/4 x 8 x 3 1/4	2.40	22.00	1/125	125	24
YEH8-9112	2-Compartment Dual Color Container	36/24	10 3/4 x 8 x 3 1/4	2.40	22.00	1/125	125	24
YEH8-9113	3-Compartment Dual Color Container	36/12/8	10 3/4 x 8 x 3 1/4	2.40	22.00	1/125	125	24
YEH8-9114	4-Compartment Dual Color Container	24/7/7/3	10 3/4 x 8 x 3 1/4	2.40	22.00	1/125	125	24
YEH8-9148	Small Dual Color Hoagie Container	--	8 1/2 x 4 1/2 x 3 1/4	2.65	14.60	2/120	240	20
YEH8-9090	9" DC Hexware™ Hinged Lid Cont. (Shallow)	38	9 x 3	3.27	14.80	1/110	110	16
YEH8-9093	9" DC Hexware™ 3-Cmpt. Hinged Lid Cont. (Shallow)	22/6/6	9 x 3	3.27	14.80	1/110	110	16
YEH8-9150	5" DC Hexware™ Hinged Lid Container	9	5 x 3	3.36	12.31	4/75	300	16
YEH8-9160	6" DC Hexware™ Hinged Lid Container	15	6 x 3	1.86	6.96	2/60	120	27
YEH8-9170	7" DC Hexware™ Hinged Lid Container	22.5	7 1/2 x 3	2.32	8.70	3/40	120	24
YEH8-9190	9" DC Hexware™ Hinged Lid Container	38	9 x 3	3.26	14.75	1/110	110	16
YEH8-9193	9" DC Hexware™ 3-Cmpt. Hinged Lid Container	22/6/6	9 x 3	3.26	14.75	1/110	110	16
EH8-9602	Small Snack Box	18	5 7/8 x 6 1/3 x 2 1/4	2.38	13.82	2/100	200	24
YEH8-9612	Medium Snack Box (Shallow)	--	5 3/4 x 7 7/8 x 2 1/4	2.35	15.80	4/50	200	24
EH8-9622	Medium Snack Box (Deep)	--	5 3/4 x 7 7/8 x 3	2.76	15.99	2/100	200	20
YEH8-9617	Large Snack Box	--	7 13/16 x 8 x 2 1/4	2.02	13.15	1/135	135	30

### APET Square Salad Containers

Product Number	Description	Dimension (in inches)	Bowl Depth (in inches)	Case Cube	Approx. Wt.	Packing Sleeve	Case
SAB0508	8 oz Black Square Bowl Base	5 x 5	1.0	3.08	14.93	8/63	504
SAB0512	12 oz Black Square Bowl Base	5 x 5	1.45	3.08	16.04	8/63	504
SAB0516	16 oz Black Square Bowl Base	5 x 5	2.0	3.08	22.71	8/63	504
SAC0508	8 oz Clear Square Bowl Base	5 x 5	1.0	3.08	14.93	8/63	504
SAC0512	12 oz Clear Square Bowl Base	5 x 5	1.45	3.08	16.04	8/63	504
SAC0516	16 oz Clear Square Bowl Base	5 x 5	2.0	3.08	22.71	8/63	504
SAB0724	24 oz Black Square Bowl Base	7.375 x 7.375	1.52	3.24	18.41	4/75	300
SAB0732	32 oz Black Square Bowl Base	7.375 x 7.375	2.0	3.24	19.07	4/75	300
SAC0724	24 oz Clear Square Bowl Base	7.375 x 7.375	1.52	3.24	18.41	4/75	300
SAC0732	32 oz Clear Square Bowl Base	7.375 x 7.375	2.0	3.24	19.07	4/75	300
SAB0948	48 oz Black Square Bowl Base	9 x 9	2.0	2.54	15.43	2/75	150
SAB0964	64 oz Black Square Bowl Base	9 x 9	2.6	2.54	17.74	2/75	150
SAC0948	48 oz Clear Square Bowl Base	9 x 9	2.0	2.54	15.43	2/75	150
SAC0964	64 oz Clear Square Bowl Base	9 x 9	2.6	2.54	17.74	2/75	150
YSACLD05	8-12-16 oz Clear Dome Lid	5 x 5	.68	2.22	12.39	6/84	504
YSACLF05	8-12-16 oz Clear Flat Lid	5 x 5	.26	2.22	12.39	6/84	504
SACLD07	24-32 oz Clear Dome Lid	7.375 x 7.375	.83	2.39	13.97	4/75	300
SACLF07	24-32 oz Clear Flat Lid	7.375 x 7.375	.26	2.39	12.64	4/75	300
SACLD09	48-64 oz Clear Dome Lid	9 x 9	.84	1.80	10.66	2/75	150
SACLF09	48-64 oz Clear Flat Lid	9 x 9	.49	1.80	9.67	2/75	150
SACLI07T	7.375" Insert for Square Salad	7.375 x 7.375	.26	0.83	8.57	2/150	300
SACLI09T	9" Insert for Square Salad	9 x 9	.26	0.67	6.21	2/75	150

## ClearView™ SmartLock® Containers

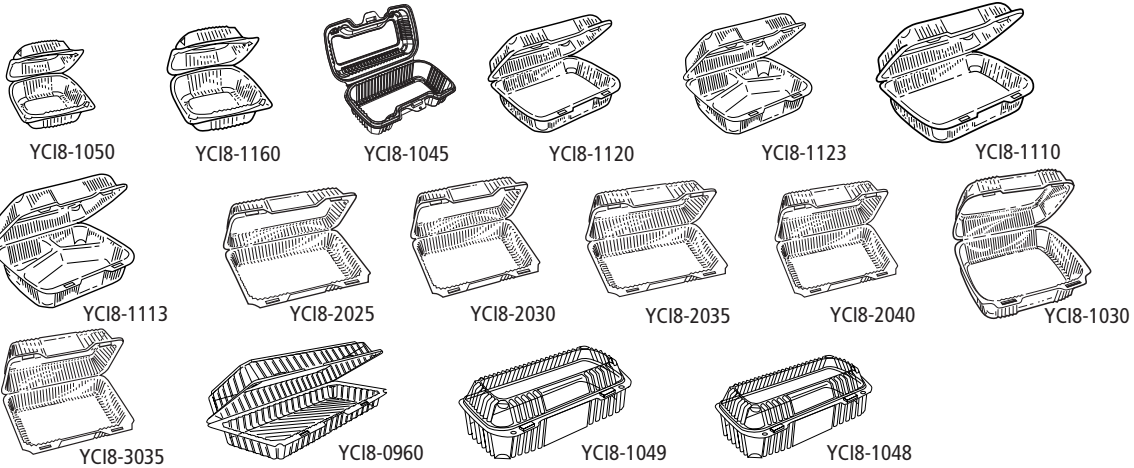

## ClearView™ Medium Platters and Domes

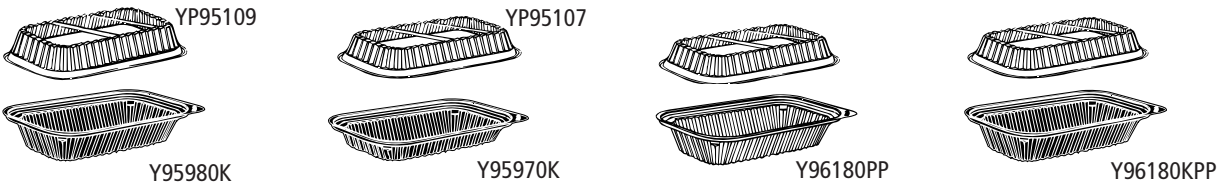

## ClearView™ Entree Platters and Domes



## ClearView™ Nacho Trays— Clear Lids, Clear Bases



## The Sell Out® Hingeware



## Reynolds® Clear Hinged Lid Containers

### ClearView™ SmartLock® Containers

Product Number	Description	Capacity (fl. oz.)	Dimension (in inches)	Cube	Case		Packing		Cases/ Unit Load
					Approx. Wt.	Sleeve	Case		
YC18-1160	Clear 6" Hinged Lid w/1-Cmpt. Tray	20 oz.	5 3/4 x 6 x 3	2.92	19.26	4/125	500	18	
YC18-1050	Clear 5" Hinged Lid w/1-Cmpt. Tray	11 oz.	5 1/4 x 5 1/4 x 2 1/2	1.75	11.24	3/125	375	36	
YC18-1045	Clear Single Tab Hotdog Container	--	6 1/2 x 2 3/4 x 2 1/4	1.58	8.27	2/125	250	36	
YC18-1048	Clear 7 1/2" Hoagie Package	23 oz.	8 1/2 x 4 x 3 1/4	1.70	11.06	2/125	250	30	
YC18-1049	Clear 9" Hoagie Package	27 oz.	9 1/4 x 4 1/2 x 3	1.98	12.76	2/125	250	30	
YC18-1120	Clear Medium Hinged Lid w/1-Cmpt. Tray	49 oz.	8 13/64 x 8 11/32 x 2 29/32	2.13	15.60	1/200	200	24	
YC18-1123	Clear Medium Hinged Lid w/3-Cmpt. Tray	5 oz.(S) - 14 oz. (L)	8 13/64 x 8 11/32 x 2 29/32	2.13	15.80	1/200	200	24	
YC18-1110	Clear Large Hinged Lid w/1-Cmpt. Tray	62 oz.	9 7/32 x 8 7/8 x 2 29/32	2.61	18.13	2/100	200	20	
YC18-1113	Clear Large Hinged Lid w/3-Cmpt. Tray	6.7 oz.(S) - 24 oz.(L)	9 7/32 x 8 7/8 x 2 29/32	2.61	18.35	2/100	200	20	
YC18-2025	Clear Small Hinged Lid	33 oz.	6 23/32 x 8 35/64 x 2 21/32	2.23	16.94	2/140	280	27	
YC18-2030	Clear Hinged Lid w/1-Cmpt. Tray (SS)	22 oz.	9 1/4 x 6 1/4 x 2	1.99	13.46	2/100	200	30	
YC18-2035	Clear Hinged Lid w/1-Cmpt. Tray (DS)	36 oz.	9 1/4 x 6 1/4 x 2 5/8	1.99	13.45	2/100	200	30	
YC18-2040	Clear Hinged Lid w/1-Cmpt. Tray (DD)	36 oz.	9 1/4 x 6 1/4 x 3 1/4	1.99	13.58	2/100	200	30	
CI8-1030	Clear Medium Hinged Lid Container - Deep	39.6 oz.	8 5/8 x 7 1/8 x 3	2.70	16.45	2/125	250	18	
YC18-3035	Clear Utility (DS)	82 oz.	10 3/4 x 9 1/4 x 3 1/2	2.38	18.40	2/75	150	24	
YC18-0960	Foot-Long Hingeware	53.7 oz.	14 5/8 x 5 5/8 x 3 1/4	4.57	20.00	2/125	250	12	

### ClearView™ Medium Platters and Domes

Product Number	Description	Capacity (fl. oz.)	Dimensions (in inches)			Cube	Case Approx. Wt.	Vert. Depth	Sleeve	Case Pack	Cases/ Unit Load
			Top Out	Top In	Bottom						
Y95980K	Black Deep Medium Platter	20	9 x 5 1/2	7 7/8 x 4 1/8	6 5/8 x 3 1/8	4.26	21.16	1 5/8	6/100	600	12
Y95970K	Black Shallow Medium Platter	13	9 x 5 1/2	7 1/2 x 4 1/16	7 1/8 x 3 3/8	3.94	12.29	1 1/8	8/75	600	12
YP95107	Clear Shallow Medium Platter Dome Lid	19	8 5/8 x 5 1/8	7 7/8 x 4 1/8	7 1/16 x 3 5/8	1.34	11.46	1 1/4	2/300	600	40
YP95109	Clear Deep Medium Platter Dome Lid	26	8 5/8 x 5 1/8	7 7/8 x 4 1/8	6 5/8 x 3 1/8	1.37	16.91	1 3/4	6/100	600	40
Y96180PP	Clear Medium Platter Tray & Lid Combo	20	9 x 5 1/2	7 7/8 x 4 1/8	6 5/8 x 3 1/8	1.88	12.39	2 1/4	2/100	200	30
Y96180KPP	Black Medium Deep Platter Tray & Lid Combo	20	9 x 5 1/2	7 7/8 x 4 1/8	6 5/8 x 3 1/8	1.88	15.75	2 1/4	2/100	200	30

### ClearView™ Entree Platters and Domes

Product Number	Description	Capacity (fl. oz.)	Dimensions (in inches)			Cube	Case Approx. Wt.	Vert. Depth	Sleeve	Case Pack	Cases/ Unit Load
			Top Out	Top In	Bottom						
Y95200W	White Entree Platter	22	10 1/8 x 7 3/8	8 3/4 x 5 7/8	8 3/8 x 5 1/2	4.58	21.50	1 3/16	4/125	500	12
Y95900K	Black Entree Platter	22	10 1/8 x 7 3/8	8 3/4 x 5 7/8	8 3/8 x 5 1/2	4.58	22.83	1 3/16	4/125	500	12
YP95108	Clear Deep Entree Platter Dome	32	9 3/4 x 7	8 7/8 x 6 1/8	8 x 5 1/4	1.90	16.88	1 1/4	4/125	500	24
Y96100KEP	Black Large Platter Tray & Lid Combo	22	10 1/8 x 7 3/8	8 3/4 x 5 7/8	8 3/8 x 5 1/2	3.50	21.75	2 1/4	2/140	280	16

### ClearView™ Nacho Trays— Clear Lids, Clear Bases

Product Number	Description	Capacity (fl. oz.)	Dimensions (in inches)	Cube	Case Approx. Wt.	Packing		Cases/ Unit Load
						Sleeve	Case	
YC18-8062	Clear 2-Cmpt. Nacho Tray	2.5 oz.(S) - 9.75 oz. (L)	6 1/2 x 5 x 1 3/4	0.79	8.41	4/125	500	70
YC18-8068	Clear Large 2-Cmpt. Nacho Tray	3.5 oz.(S) - 15.5 oz. (L)	6 x 8 x 1 3/4	1.50	11.04	4/125	500	36
YC18-8063	Clear 1-Cmpt. Tray & Lid Combo	20 oz.	6 1/2 x 5 x 1 3/4	1.61	9.07	2/126	252	32

### The Sell Out® Hingeware

Product Number	Description	Capacity (fl. oz.)	Dimensions (in inches)			Vert. Depth	Case Cube	Case Weight	Sleeve	Case Pack	Cases/ Unit Load
			Top Out	Top In	Bottom						
Y94121	Medium Deep Clear Hingeware	--	9 x 8	7 3/4 x 6 3/4	6 7/16 x 5 7/16	3 3/8	2.07	16.56	2/90	180	24
Y94130	Medium Low Profile Clear Hingeware	--	9 x 8	7 3/4 x 6 3/4	7 1/4 x 6 1/4	1 13/16	2.07	16.56	2/90	180	24
Y94111	Large Deep Clear Hingeware	51B + 50 1/2L	9 1/2 x 9 1/2	8 3/16 x 8 1/4	6 7/8 x 6 7/8	3 3/8	2.57	15.34	2/80	160	20
Y94119	Large Super Deep Clear Hingeware	63B/52L	9 1/2 x 9 1/2	8 3/16 x 8 1/4	6 7/8 x 6 7/8	3 7/8	2.81	18.40	2/85	170	20

### Reynolds® Clear Hinged Lid Containers

Product Number	Description	Dimensions (in inches)	Cube	Case		Sleeve	Case Pack	Cases/ Unit Load
				Weight	Sleeve			
11970	10" Hingeware	10 x 10	5.39	28.98	2/100	200	20	
11974	6" Enhanced Hingeware	6 x 6	5.72	18.47	6/84	504	16	
12016	5" Enhanced Hingeware	5 x 5	4.42	14.00	6/84	504	20	
2155P300	Square Hinged Bar-Lock	8.25 x 9 x 3	3.70	28.70	1/300	300	24	
2170P200	Large Square Hinged Bar-Lock	8.1 x 8.75 x 3.5	2.82	18.22	1/200	200	30	
2175	Small Danish Hinged Bar-Lock	12.44 x 6.38 x 2.25	1.43	10.00	1/100	100	54	
2221	5" Square Hinged Bar-Lock	5.75 x 5.2 x 3.25	3.34	18.23	4/125	500	16	

**Clear Advantage™ SmartLock® Bakery/Deli Hingeware – RPET**

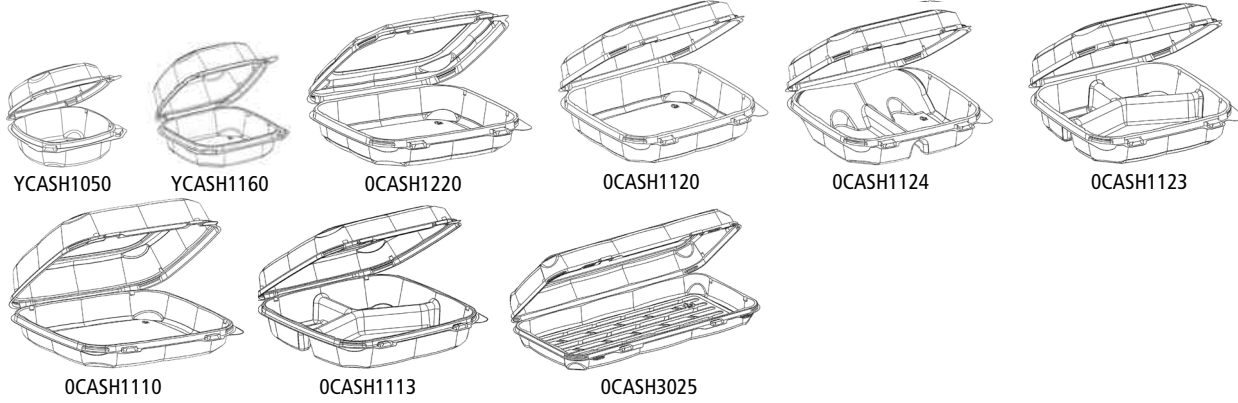

**Reynolds® CaterTime® Lock-Fresh™ Salad Bowls - PETE**

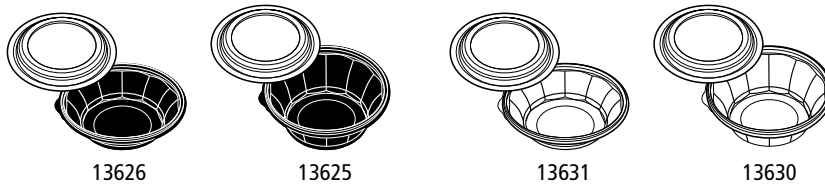

**Reynolds® Grandstand™ Hinged Bowls - PETE**

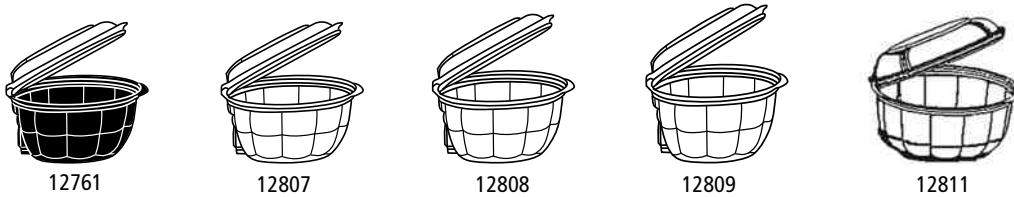

**Reynolds® Octagons - PETE**

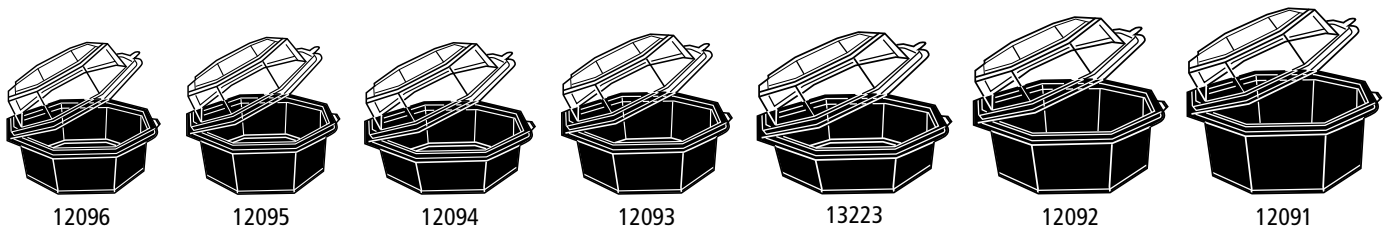

**Newspring VERSAtainer® Microwaveable Containers - Oval**

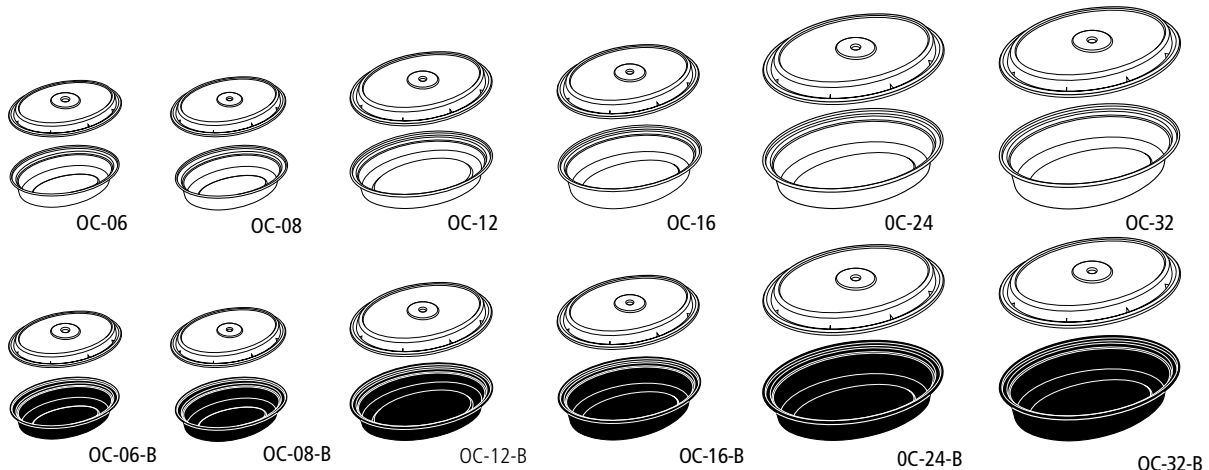

**Clear Advantage™ SmartLock® Bakery/Deli Hingeware – RPET**

Product Number	Description	Capacity (fl. oz.)	Dimension (in inches)	Cube	Case Approx Wt.	Packing Sleeve	Case	Cases/ Unit Load
YCASH1050	RPET Clear 5" Hinged Lid w/1-Cmpt. Tray	11 oz.	5 1/4 x 5 1/4 x 2 1/2	1.75	11.24	3/125	375	36
YCASH1160	RPET Clear 6" Hinged Lid w/1-Cmpt. Tray	20 oz.	5 3/4 x 6 x 3	2.92	24.16	4/125	500	18
OCASH1120	RPET Clear Medium Hinged Lid w/1-Cmpt. Tray	49 oz.	8 13/64 x 8 11/32 x 2 29/32	2.14	17.47	2/100	200	24
OCASH1123	RPET Clear Medium Hinged Lid w/3-Cmpt. Tray	5 oz.(S) - 14 oz. (L)	8 13/64 x 8 11/32 x 2 29/32	2.14	19.48	1/200	200	24
OCASH1110	RPET Clear Large Hinged Lid w/1-Cmpt. Tray	62 oz.	9 7/32 x 8 7/8 x 2 29/32	2.61	22.70	2/100	200	20
OCASH1124	RPET Clear Medium Hinged Cookie Container	49 oz.	8 13/64 x 8 11/32 x 2 29/32	2.14	19.48	1/200	200	24
OCASH-1030	RPET Clear Medium Hinged Container - Deep	39.6	8 5/8 x 7 3/4 x 3 1/4	2.66	24.70	2/125	250	18
OCASH3025	RPET Clear Large Hinged Strudel Container	44 oz.	6 55/64 x 13 21/34 x 2 1/4	1.69	11.00	2/50	100	27
OCASH9446	RPET Clear 12-Cup Cupcake/Muffin Hinged Container - 2 1/2" Cup Diameter	N/A	13 x 10 1/15 x 3 1/8	2.89	14.00	2/50	100	18
OCASH0970	RPET Clear Hinged 8" x 8" Bakery Container	170 oz.	8 3/4 x 8 1/4 x 3 5/8	2.78	21.02	2/100	200	18
OCASH9140	RPET Clear Hinged 4 Count Muffin Container	N/A.	8 3/8 x 7 1/8 x 3	2.83	24.74	2/126	252	18

\*Part of the EarthChoice® line of RPET containers

**Reynolds® CaterTime® Lock-Fresh™ Salad Bowls - PETE**

Product Number	Description	Color	Dimensions (in inches)			Vert. Depth	Cube	Case Weight	Case Pack	Cases/ Unit Load
			Top Out	Top In	Bottom					
13626	24 oz. Combo Salad Bowl	Black/Clear	9	8	5 1/2	2	3.45	11.70	100	30
13625	35 oz. Combo Salad Bowl	Black/Clear	9	8	5 1/2	2 3/4	3.45	11.70	100	30
13631	24 oz. Combo Salad Bowl	Clear/Clear	9	8	5 1/2	2	3.45	11.70	100	30
13630	35 oz. Combo Salad Bowl	Clear/Clear	9	8	5 1/2	2	3.45	11.70	100	30

**Reynolds® Grandstand™ Hinged Bowls - PETE**

Product Number	Description	Color	Dimensions (in inches)			Cube	Case Weight	Case Pack	Cases/ Unit Load
			Top Out	Top In	Bottom				
12761	18 oz. Hinged Bowl	Black Base	7 1/4	2 3/4	4	2.80	14.00	150	35
12807	18 oz. Hinged Bowl	Clear	7 1/4	2 3/4	4	2.82	13.00	150	35
12808	28 oz. Hinged Bowl	Clear	7 1/4	4	4	2.83	13.65	150	35
12809	35 oz. Hinged Bowl	Clear	7 1/4	3	4	2.83	13.65	150	35
12811	54 oz. Hinged Bowl	Clear	8	4 3/8	3 1/4	3.58	16.00	130	30

**Reynolds® Octagons - PETE**

Product Number	Description	Color	Dimensions (in inches)		Vert. Depth	Cube	Case Weight	Case Pack	Cases/ Unit Load
			Top Out	Base Height					
12096	16 oz. Octagonal Clamshell	Clear Lid/Black Base	6 1/2	1 1/4	2 5/8	2.18	12.00	150	42
12095	19 oz. Octagonal Clamshell	Clear Lid/Black Base	6 1/2	1 1/2	3 1/4	2.18	12.00	150	42
12094	22 oz. Octagonal Clamshell	Clear Lid/Black Base	7 3/4	1 1/8	2 1/2	3.03	15.00	150	36
12093	29 oz. Octagonal Clamshell	Clear Lid/Black Base	7 3/4	1 1/2	3 1/4	3.11	17.00	150	36
13223	30 oz. Octagonal Clamshell	Clear Lid/Black Base	9 1/8	1 1/8	2	4.51	20.00	150	16
12092	33 oz. Octagonal Clamshell	Clear Lid/Black Base	9 1/8	1 1/8	2 1/2	4.40	21.00	150	16
13173	8/8/8/4 oz. Hinged Bowl - 4 Compartment	Clear Lid/Black Base	9 1/8	1 1/8	2 1/2	4.51	21.00	150	16
12091	44 oz. Octagonal Hinged Bowl	Clear Lid/Black Base	9 1/8	1 1/2	3 1/4	4.40	24.00	150	16

**Newspring VERSAtainer® Microwaveable Containers - Oval**

Product #	Description	Dimensions	Case Pack	Case Cube	Cs Wt (lbs.)	Pallet Count	Ti/Hi
OC-06	6 oz. white base w/ clear lid	5.7" x 4.0" x 1.1"	150 ea.	1.09	7.27	48	12/4
OC-06-B	6 oz. black base w/ clear lid	5.7" x 4.0" x 1.1"	150 ea.	1.06	7.27	48	12/4
OC-08	8 oz. white base w/ clear lid	5.7" x 4.0" x 1.45"	150 ea.	1.09	7.64	48	12/4
OC-08-B	8 oz. black base w/ clear lid	5.7" x 4.0" x 1.45"	150 ea.	1.09	7.64	48	12/4
OC-12	12 oz. white base w/ clear lid	6.8" x 4.8" x 1.45"	150 ea.	1.43	10.23	30	15/2
OC-12-B	12 oz. black base w/ clear lid	6.8" x 4.8" x 1.45"	150 ea.	1.43	10.23	30	15/2
OC-16	16 oz. white base w/ clear lid	6.8" x 4.8" x 1.9"	150 ea.	1.48	10.73	30	15/2
OC-16-B	16 oz. black base w/ clear lid	6.8" x 4.8" x 1.9"	150 ea.	1.48	10.73	30	15/2
OC-24	24 oz. white base w/ clear lid	9.1" x 6.7" x 1.45"	150 ea.	2.60	18.35	20	10/2
OC-24-B	24 oz. black base w/ clear lid	9.1" x 6.7" x 1.45"	150 ea.	2.60	18.35	20	10/2
OC-32	32 oz. white base w/ clear lid	9.1" x 6.7" x 1.9"	150 ea.	2.63	18.60	20	10/2
OC-32-B	32 oz. black base w/ clear lid	9.1" x 6.7" x 1.9"	150 ea.	2.63	18.60	20	10/2

\* Newspring VERSAtainer® products are shipped in 150 count containers/lid combination packs. All products listed above are also available in a 300 count bulk pack by special order only.

**Newspring VERSAtainer® Microwaveable Containers - Square**

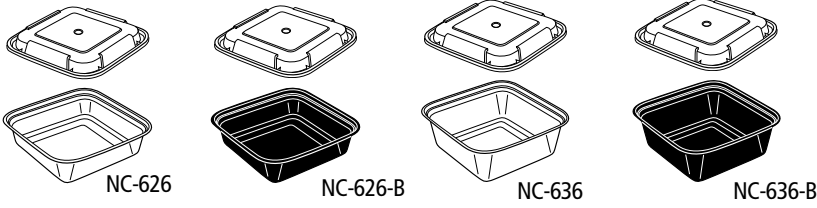

**Newspring VERSAtainer® Microwaveable Containers - Round**

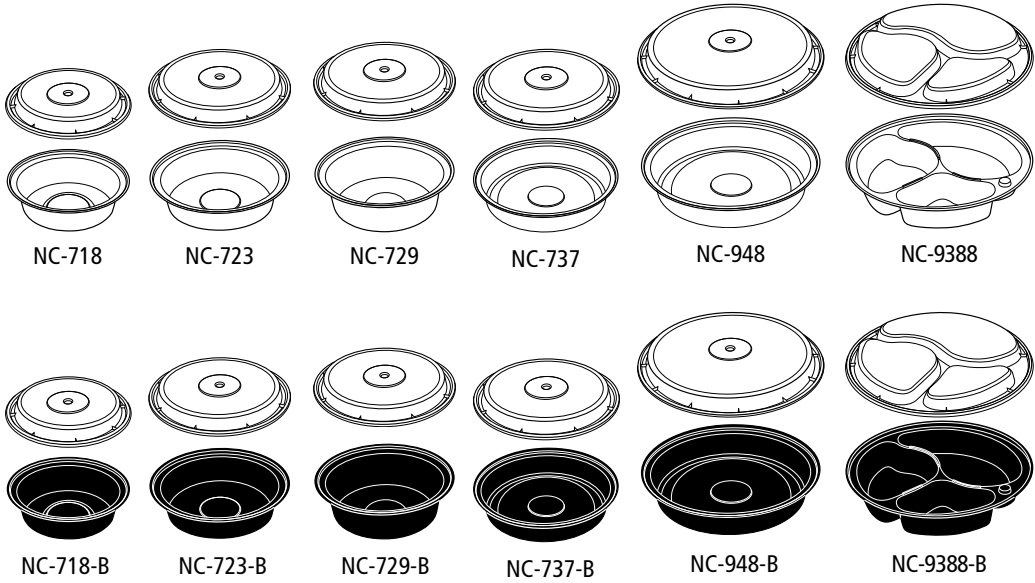

**Newspring VERSAtainer® Microwaveable Containers - Rectangular**

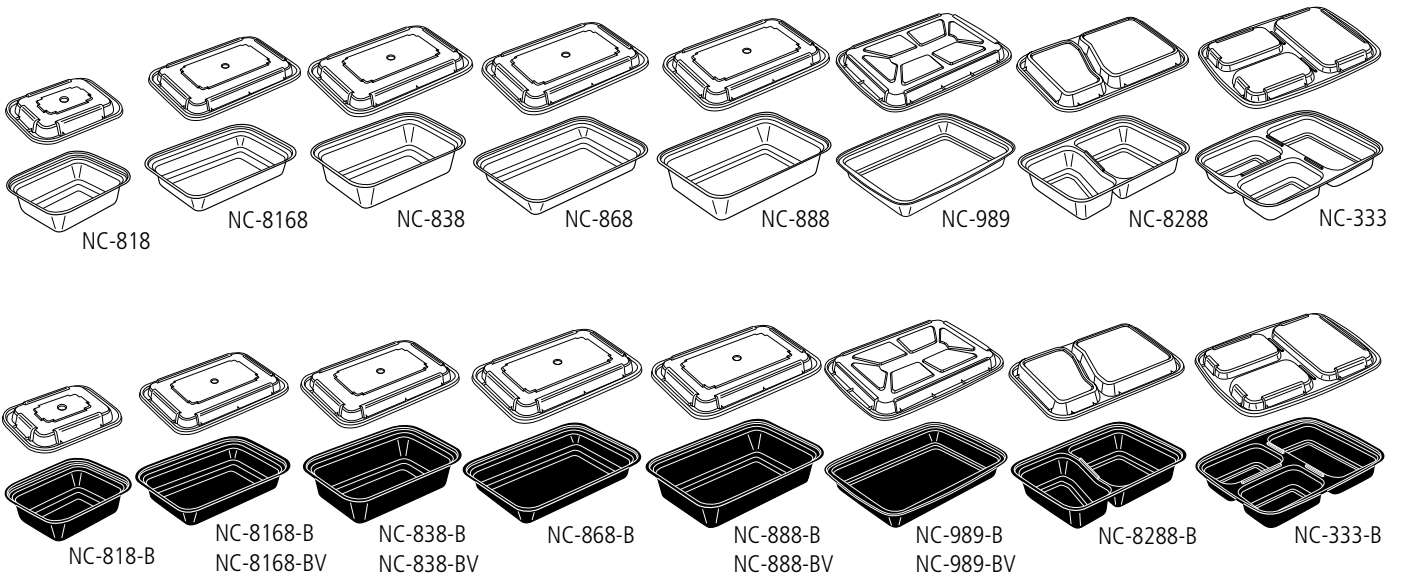

### VERSAtainer® Microwaveable Containers - Square

Product #	Description	Dimensions	Case Pack	Case Cube	Cs Wt (lbs.)	Pallet Count	Ti/Hi
NC-626	26 oz. white base w/ clear lid	6.75" x 6.75" x 2"	150 ea.	1.98	17.29	20	10/2
NC-626-B	26 oz. black base w/ clear lid	6.75" x 6.75" x 2"	150 ea.	1.98	17.29	20	10/2
NC-636	36 oz. white base w/ clear lid	6.75" x 6.75" x 2.625"	150 ea.	2.04	19.19	20	10/2
NC-636-B	36 oz. black base w/ clear lid	6.75" x 6.75" x 2.625"	150 ea.	2.04	19.19	20	10/2

### VERSAtainer® Microwaveable Containers - Round

Product #	Description	Dimensions	Case Pack	Case Cube	Cs Wt (lbs.)	Pallet Count	Ti/Hi
NC-718	16 oz. white base w/ clear lid	6" x 1.5"	150 ea.	1.90	12.81	21	7/3
NC-718-B	16 oz. black base w/ clear lid	6" x 1.5"	150 ea.	1.90	12.81	21	7/3
NC-723	24 oz. white base w/ clear lid	7" x 1.5"	150 ea.	2.15	16.30	20	10/2
NC-723-B	24 oz. black base w/ clear lid	7" x 1.5"	150 ea.	2.15	16.30	20	10/2
NC-729	32 oz. white base w/ clear lid	7" x 2"	150 ea.	2.21	17.16	20	10/2
NC-729-B	32 oz. black base w/ clear lid	7" x 2"	150 ea.	2.21	17.16	20	10/2
NC-737	35 oz. white base w/ clear lid	8" x 1.5"	150 ea.	2.94	22.95	12	6/2
NC-737-B	35 oz. black base w/ clear lid	8" x 1.5"	150 ea.	2.94	22.95	12	6/2
NC-948	48 oz. white base w/ clear lid	9" x 1.5"	150 ea.	3.54	26.42	12	6/2
NC-948-B	48 oz. black base w/ clear lid	9" x 1.5"	150 ea.	3.54	26.42	12	6/2
<b>Three Compartments (7 oz/12 oz/20 oz)</b>							
NC-9388	39 oz. white base w/ clear lid	9" x 1.5"	150 ea.	3.65	31.86	12	6/2
NC-9388-B	39 oz. black base w/ clear lid	9" x 1.5"	150 ea.	3.65	31.86	12	6/2
<b>Vented Containers</b>							
NC-948-BV	48 oz. black base w/ vented clear lid	9" x 1.5"	150 ea.	3.54	26.42	12	6/2

### VERSAtainer® Microwaveable Containers - Rectangular

Product #	Description	Dimensions	Case Pack	Case Cube	Case Weight (lbs.)	Pallet Count
NC-818	12 oz. white base w/ clear lid	4.5" x 5.5" x 1.75"	150 ea.	1.10	9.57	54
NC-818-B	12 oz. black base w/ clear lid	4.5" x 5.5" x 1.75"	150 ea.	1.10	9.57	54
NC-8168	16 oz. white base w/ clear lid	5" x 7.25" x 1.5"	150 ea.	1.35	14.15	60
NC-8168-B	16 oz. black base w/ clear lid	5" x 7.25" x 1.5"	150 ea.	1.35	14.15	60
NC-838	24 oz. white base w/ clear lid	5" x 7.25" x 2"	150 ea.	1.39	13.68	60
NC-838-B	24 oz. black base w/ clear lid	5" x 7.25" x 2"	150 ea.	1.39	13.68	60
NC-868	28 oz. white base w/ clear lid	6" x 8.5" x 1.5"	150 ea.	1.89	18.59	40
NC-868-B	28 oz. black base w/ clear lid	6" x 8.5" x 1.5"	150 ea.	1.89	18.59	40
NC-888	38 oz. white base w/ clear lid	6" x 8.5" x 2"	150 ea.	1.96	19.04	40
NC-888-B	38 oz. black base w/ clear lid	6" x 8.5" x 2"	150 ea.	1.96	19.04	40
NC-989	58 oz. white base w/ clear lid	8.5" x 11.5" x 1.5"	150 ea.	2.82	33.89	20
NC-989-B	58 oz. black base w/ clear lid	8.5" x 11.5" x 1.5"	150 ea.	2.82	33.89	20
<b>Two Compartments (12 oz/18 oz)</b>						
NC-8288	30 oz. white base w/ clear lid	6" x 8.5" x 1.875"	150 ea.	1.98	18.50	40
NC-8288-B	30 oz. black base w/ clear lid	6" x 8.5" x 1.875"	150 ea.	1.98	18.50	40
<b>Three Compartments (8 oz/8 oz/16 oz)</b>						
NC-333	32 oz. white base w/ clear lid	7.5" x 9.875" x 1.75"	150 ea.	2.35	27.97	32
NC-333-B	32 oz. black base w/ clear lid	7.5" x 9.875" x 1.75"	150 ea.	2.35	27.97	32
<b>Vented Containers</b>						
NC-8168-BV	16 oz. black base w/ vented clear lid	5" x 7.25" x 1.5"	150 ea.	1.58	14.15	48
NC-838-BV	24 oz. black base w/ vented clear lid	5" x 7.25" x 2"	150 ea.	1.77	13.68	42
NC-888-BV	38 oz. black base w/ vented clear lid	6" x 8.5" x 2"	150 ea.	1.96	19.04	40
NC-989-BV	58 oz. black base w/ vented clear lid	8.5" x 11.5" x 1.5"	150 ea.	2.82	33.89	20

\* All products listed above are shipped in 150 clear lid packs. All products listed above are also available in a 300 count bulk pack by special order only.

**Dopaco Paper Hot Dog/Hamburger/Multi-Use/Snack/Dinner Clamshells**

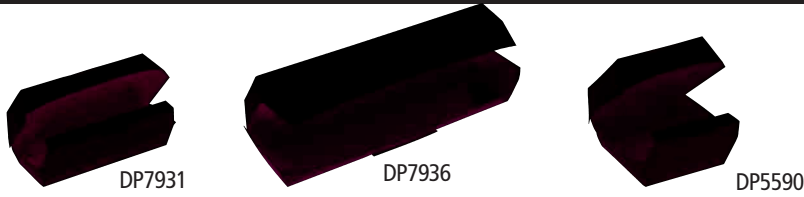

**Dopaco Paper Auto Bottom/Fast Top Boxes**



**Dopaco Paper Handled Barn Boxes**

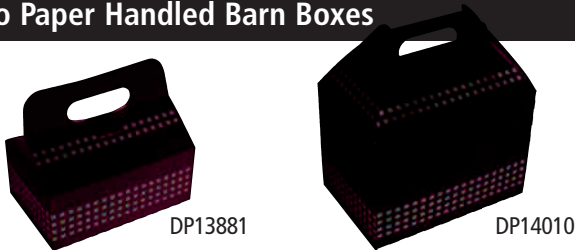

**Dopaco Paper Food Containers - Bulk**



**Dopaco Paper Food Containers - Combo**



**Dopaco Paper Stock Food Trays**

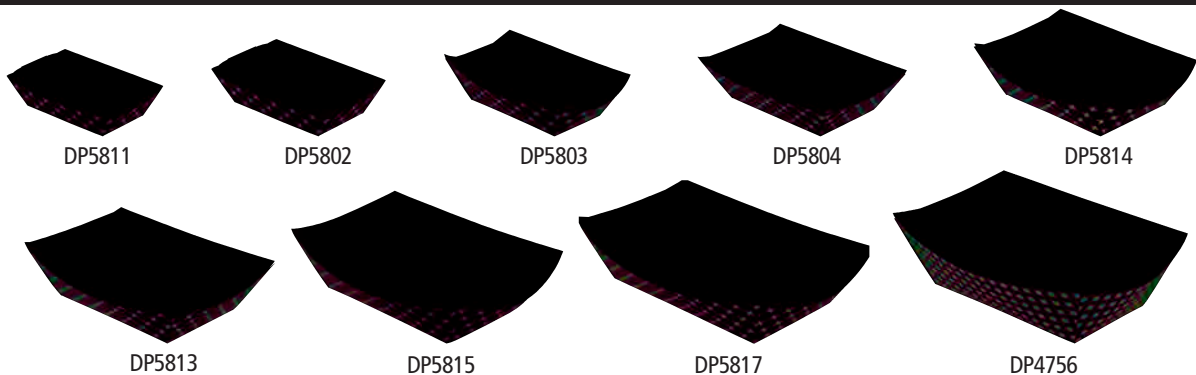



### Dopaco Paper Hot Dog/Hamburger/Multi-Use/Snack/Dinner Clamshells

Product Number	Description	Ounce Capacity	Dimensions (in inches)	Cube	Case		Packing		Ti/Hi	Cases/ Unit Load
					Approx Wt.	Sleeve	Case			
DP7931	Regular Hot Dog Clamshell	5	6.87 x 2.57 x 2.25	1.62	16.13	--	500	9/5	45	
DP7936	Large Hot Dog Clamshell	7	11.12 x 2.87 x 2.25	3.12	28.15	--	500	5/5	25	
DP5590	5" Hamburger Clamshell	5	4.79 x 4.81 x 2.75	2.20	20.70	--	500	5/7	35	

### Dopaco Paper Auto Bottom/Fast Top Boxes

Product Number	Description	Ounce Capacity	Dimensions (in inches)	Cube	Case		Packing		Ti/Hi	Cases/ Unit Load
					Approx Wt.	Sleeve	Case			
DP7964	Snack Box - White	7	7.00 x 4.25 x 2.75	1.35	31.06	--	500	8/5	40	
DP6751	Snack Box - Basketweave	7	7.00 x 4.25 x 2.75	1.35	32.40	--	500	8/5	40	
DP3842	Dinner Box - White	?	8.93 x 4.93 x 3.07	1.57	35.00	--	400	9/6	54	
DP3753	Dinner Box - Basketweave	?	8.93 x 4.93 x 3.07	1.57	35.00	--	400	9/6	54	
DP8163	Large Dinner Box - White	?	8.93 x 4.93 x 5.00	2.00	39.00	--	300	9/5	45	

### Dopaco Paper Handled Barn Boxes

Product Number	Description	Ounce Capacity	Dimensions (in inches)	Cube	Case		Packing		Ti/Hi	Cases/ Unit Load
					Approx Wt.	Sleeve	Case			
DP13881	Medium Barn Box - Basketweave	?	8.50 x 5.50 x 5.68	1.15	19.87	--	150	13/5	65	
DP14010	Large Barn Box - Basketweave	?	9.00 x 5.93 x 3.07	1.90	31.13	--	150	8/5	40	

### Dopaco Paper Food Containers - Bulk

Product Number	Description	Cube	Case		Packing		Ti/Hi	Cases/ Unit Load
			Approx Wt.	Sleeve	Case			
DP15686	8 oz. White Container	2.90	10.60	20/25	500	6/6	36	
DP15459	12 oz. White Container	2.40	12.40	20/25	500	6/6	36	
DP15460	16 oz. White Container	2.90	14.70	20/25	500	6/6	36	
DP20636	32 oz. White Container	4.22	21.48	20/25	500	4/4	16	
DP18264	12 oz. Fresh Delicious Container	2.40	12.40	20/25	500	6/6	36	
DP18268	16 oz. Fresh Delicious Container	2.90	14.70	20/25	500	6/5	30	
DP15561	8/12/16 oz. White Plastic Lid	3.10	13.00	20/50	1000	6/5	30	
DP18934	32 oz. White Plastic Container Lid	3.33	7.50	10/50	500	8/5	40	

Special print & custom designs products available upon submission of color and volume requirements

### Dopaco Paper Food Containers - Combo

Product Number	Description	Cube	Case		Packing		Ti/Hi	Cases/ Unit Load
			Approx Wt.	Sleeve	Case			
DP14200	8 oz. White Containers w/Lids	2.03	10.60	--	250	8/5	40	
DP14201	12 oz. White Containers w/Lids	2.06	11.00	--	250	8/5	40	
DP14362	16 oz. White Containers w/Lids	2.30	11.00	10/25	250	8/5	40	
DP18263	8 oz. Fresh Delicious Containers w/Lids	2.03	10.60	10/25	250	8/5	40	
DP18266	12 oz. Fresh Delicious Containers w/Lids	2.06	11.00	10/25	250	8/5	40	
DP18267	16 oz. Fresh Delicious Containers w/Lids	2.30	11.00	10/25	250	8/5	40	

### Dopaco Paper Stock Food Trays

Product Number	Description	Ounce Capacity	Dimensions (in inches)	Cube	Case		Packing		Ti/Hi	Cases/ Unit Load
					Approx Wt.	Sleeve	Case			
DP5811	#25 4 oz. Basketweave Tray	4	4.07 x 2.67 x 1.08	0.55	6.78	4/250	1000	17/8	136	
DP5802	#40 6 oz. Basketweave Tray	6	4.68 x 2.91 x 1.25	0.62	8.12	4/250	1000	15/7	105	
DP5803	#40 8 oz. Basketweave Tray	8	5.03 x 2.00 x 1.50	0.56	10.00	4/250	1000	15/6	90	
DP5804	#100 1 lb. Basketweave Tray	16	5.80 x 3.61 x 1.62	1.03	13.22	4/250	1000	15/6	90	
DP5814	#200 2 lb. Basketweave Tray	32	6.12 x 4.10 x 1.75	1.20	17.56	4/250	1000	14/5	70	
DP5813	#250 2.5 lb. Basketweave Tray	40	6.91 x 4.53 x 2.00	0.78	12.98	2/250	500	9/10	90	
DP5815	#300 3 lb. Basketweave Tray	48	7.68 x 4.90 x 2.18	0.95	12.98	2/250	500	10/9	90	
DP5817	#500 5 lb. Basketweave Tray	80	9.18 x 5.43 x 2.43	0.86	12.98	2/250	500	8/8	64	
DP4756	10 lb. Basketweave Tray	160	9.24 x 6.14 x 2.81	1.30	12.98	2/125	250	12/5	60	
DP7651	White School Tray	48	9.12 x 6.18 x 2.00	3.30	31.60	4/125	500	7/4	28	
DP7654	Red Barrel School Tray	48	9.12 x 6.18 x 2.00	3.50	31.60	4/125	500	7/4	28	

## Dopaco Paper Stock Hot Dog Trays

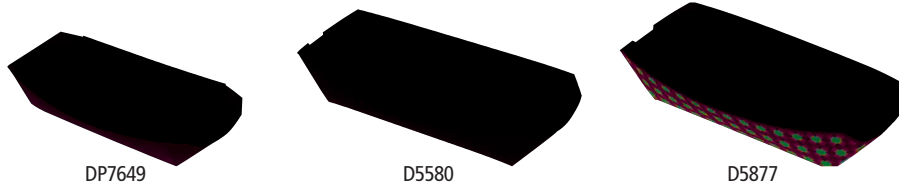

DP7649

D5580

D5877

## Dopaco Paper Specialty Food Trays

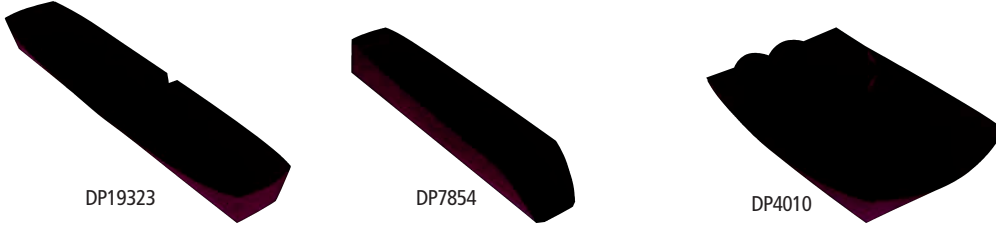

DP19323

DP7854

DP4010

## Dopaco Paper E Trays

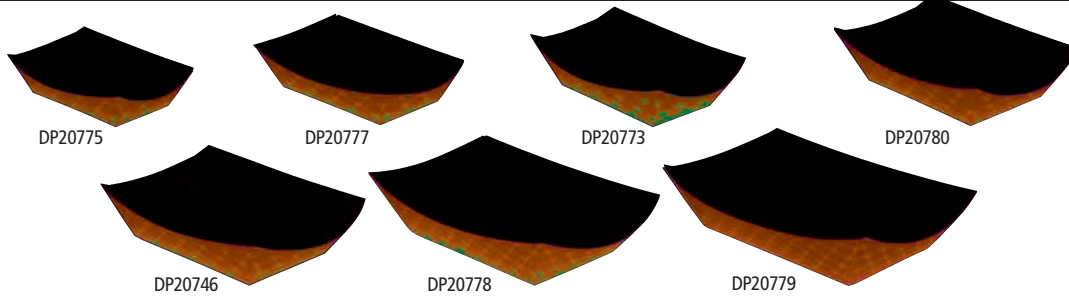

DP20775

DP20777

DP20773

DP20780

DP20746

DP20778

DP20779

## Dopaco Paper Nested Fry Cartons

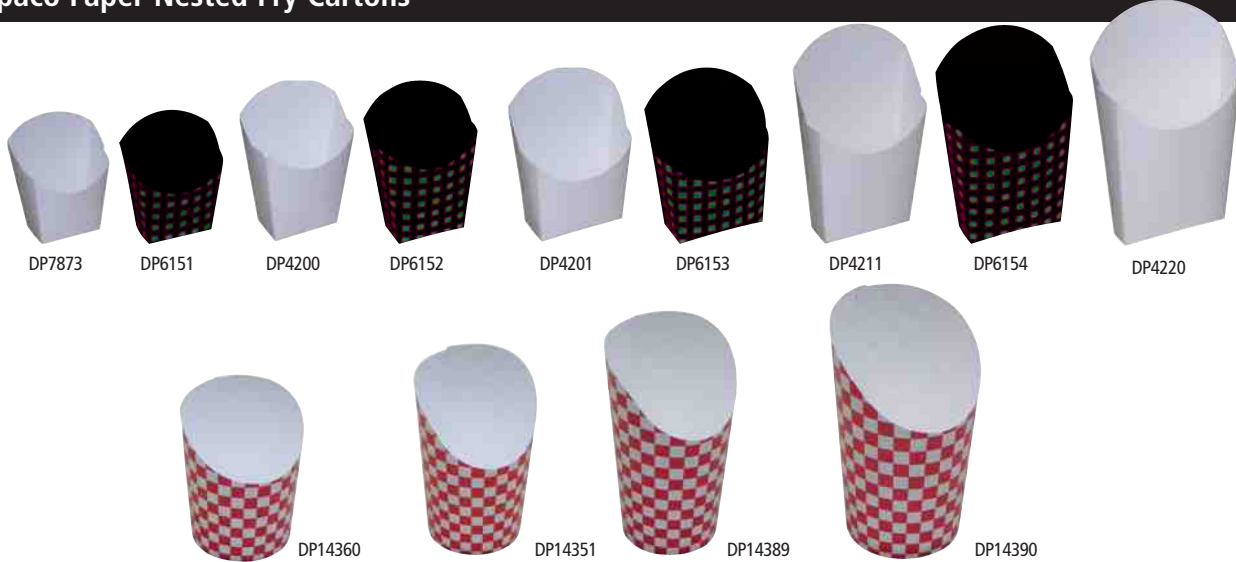

DP7873

DP6151

DP4200

DP6152

DP4201

DP6153

DP4211

DP6154

DP4220

DP14360

DP14351

DP14389

DP14390

## Dopaco Paper Triangular Pizza Clamshells

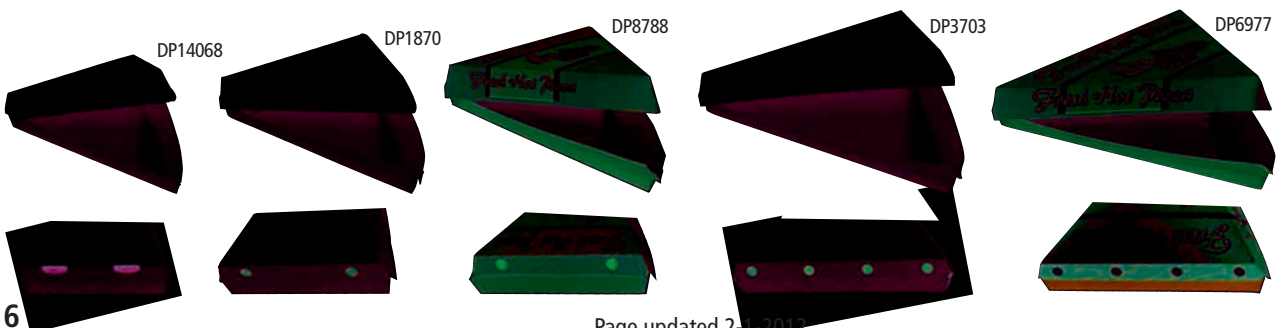

DP14068

DP1870

DP8788

DP3703

DP6977

### Dopaco Paper Stock Hot Dog Trays

Product Number	Description	Ounce Capacity	Dimensions (in inches)	Cube	Case		Packing		Ti/Hi	Cases/ Unit Load
					Approx Wt.	Sleeve	Case			
DP7649	Regular White Hot Dog Tray	48	5.0 x 1.87 x 1.37	0.92	11.80	4/250	1000	8/5	40	
DP5580	Regular White Hot Dog Tray	48	7.04 x 1.75 x 1.43	0.92	11.80	4/250	1000	9/9	81	
DP5877	Regular Basketweave Hot Dog Tray	48	7.04 x 1.75 x 1.43	0.92	11.80	4/250	1000	9/9	81	

### Dopaco Paper Specialty Food Trays

Product Number	Description	Ounce Capacity	Dimensions (in inches)	Cube	Case		Packing		Ti/Hi	Cases/ Unit Load
					Approx Wt.	Sleeve	Case			
DP19323	Hot Dog Holder w/Perforation	32	12.51 x 2.06 x 1.75	1.19	11.66	2/250	500	6/10	60	
DP7854	Super Hot Dog Holder - <i>as needed</i>	--	--	0.49	17.00	2/250	500	16/8	128	
DP4010	3 lb. Pocket Tray - White	48	5.38 x 3.38 x 2	1.56	15.48	2/200	400	10/6	60	

### Dopaco Paper E Trays

Product Number	Description	Ounce Capacity	Dimensions (in inches)	Cube	Case		Packing		Ti/Hi	Cases/ Unit Load
					Approx Wt.	Sleeve	Case			
DP20775	4 oz. Basketweave E Tray	4	4.01 x 2.62 x 1.02	0.79	8.81	4/250	1000	13/8	104	
DP20777	6 oz. Basketweave E Tray	6	4.37 x 2.86 x 1.18	0.81	10.68	4/250	1000	14/7	98	
DP20773	8 oz. Basketweave E Tray	8	5.14 x 3.10 x 1.37	0.92	13.21	4/250	1000	15/6	90	
DP20780	1 lb. Basketweave E Tray	16	5.63 x 3.65 x 1.49	1.11	16.58	4/250	1000	13/6	78	
DP20746	2 lb. Basketweave E Tray	32	6.15 x 4.25 x 1.70	1.49	20.54	4/250	1000	10/5	50	
DP20778	3 lb. Basketweave E Tray	48	7.61 x 5.06 x 2.09	0.95	15.30	2/250	500	10/9	90	
DP20779	5 lb. Basketweave E Tray	80	9.08 x 5.46 x 2.24	1.41	19.80	2/250	500	8/8	64	

### Dopaco Paper Nested Fry Cartons

Product Number	Description	Ounce Capacity	Dimensions (in inches)	Cube	Case		Packing		Ti/Hi	Cases/ Unit Load
					Approx Wt.	Sleeve	Case			
DP7873	2.5 oz. Junior Fry - White	2.5	3.28 x 1.65 x 3.90	0.76	11.06	20/50	1000	10/8	80	
DP6151	2.5 oz. Junior Fry - Basketweave	2.5	3.28 x 1.65 x 3.90	0.76	11.04	8/125	1000	10/8	80	
DP4200	3.5 oz. Regular Fry - White	3.5	3.21 x 1.64 x 4.71	0.95	13.70	8/125	1000	10/8	80	
DP6152	3.5 oz. Regular Fry - Basketweave	3.5	3.21 x 1.64 x 4.71	0.95	13.70	8/125	1000	10/8	80	
DP4201	5 oz. Large Fry - White	5	3.54 x 1.85 x 5.04	1.67	14.80	8/125	1000	9/5	45	
DP6153	5 oz. Large Fry - Basketweave	5	3.54 x 1.85 x 5.04	1.67	15.50	20/50	1000	9/5	45	
DP4211	6 oz. Jumbo Fry - White	6	3.63 x 1.70 x 6.10	1.94	18.20	20/50	1000	6/6	36	
DP6154	6 oz. Jumbo Fry - Basketweave	6	3.63 x 1.70 x 6.10	1.94	18.20	8/125	1000	6/6	36	
DP4220	7 oz. Super Size Fry - White	7	4.32 x 7.00 x 1.99	2.37	25.90	20/50	1000	8/4	32	
DP14360	3 oz. Finger Food Scoop	3	--	1.38	22.00	20/50	1000	9/3	27	
DP14351	5 oz. Finger Food Scoop	5	--	2.56	25.00	20/50	1000	9/3	27	
DP14389	6 oz. Finger Food Scoop	6	--	3.02	25.00	20/50	1000	9/3	27	
DP14390	7 oz. Finger Food Scoop	7	--	4.32	21.09	20/50	1000	6/3	18	

### Dopaco Paper Triangular Pizza Clamshells

Product Number	Description	Ounce Capacity	Dimensions (in inches)	Cube	Case		Packing		Ti/Hi	Cases/ Unit Load
					Approx Wt.	Sleeve	Case			
DP14068	14/8 Pizza Clamshell - White	14/8	8.26 x 6.56 x 1.5	2.90	18.76	--	500	5/6	30	
DP1870	16/8 Pizza Clamshell - White	16/8	9.37 x 7.48 x 1.75	4.09	20.80	--	400	4/6	24	
DP8788	16/8 Pizza Clamshell - Fresh Hot	16/8	9.37 x 7.48 x 1.75	4.09	20.80	--	400	4/6	24	
DP3703	18/6 Pizza Clamshell - White	18/6	10.90 x 9.93 x 1.62	2.56	14.40	--	220	4/9	36	
DP6977	18/6 Pizza Clamshell - Fresh Hot	18/6	10.90 x 9.93 x 1.62	2.56	14.40	--	220	4/9	36	

## Dopaco Paper Pizza & Calzone Clamshells

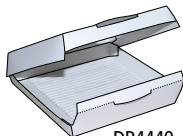

DP4440



DP8768



DP9167



DP18074



DP1969



DP15583

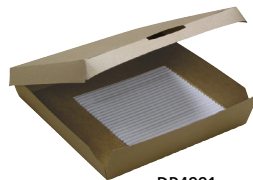

DP4991



DP5012

## Dopaco Paper Triangular Slice Tray

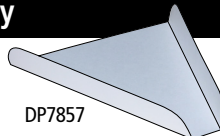

DP7857

## ONEbox™ Paper Boxes



SMB02BLK



SMB03WHT



SMB08BLK



SMB01KEC

## EarthChoice® PLA Portion Cups & Lids

YLSPLA-2



YSPLA-200EC

YLSPLA-3



YSPLA-300EC



YSPLA-400EC

## EarthChoice® PLA Hinged & Deli Containers



YL18-1160-0000



YL18-1120-0000

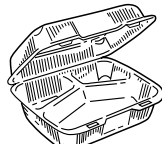

YL18-1123-0000

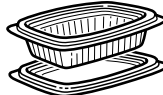

YL18-6008-0000



YL18-6016-0000

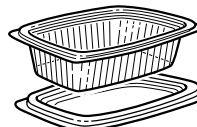

YL18-6024-0000

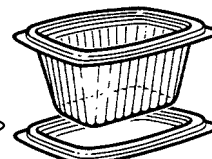

YL18-6032-0000

### Dopaco Paper Pizza & Calzone Clamshells

Product Number	Description	Ounce Capacity	Dimensions (in inches)	Cube	Case		Packing		Cases/ Unit Load
					Approx Wt.	Sleeve	Case	Ti/Hi	
DP4440	6" Pizza Clamshell w/Pad - White	6	6.96 x 6.70 x 1.75	2.53	18.45	--	250	6/5	30
DP8768	6" Pizza Clamshell w/Pad - Fresh Hot	6	6.96 x 6.70 x 1.75	2.53	18.45	--	250	6/5	30
DP9167	7" Pizza Clamshell w/Pad - Fresh Hot	7	7.84 x 7.60 x 1.75	3.26	20.77	--	250	6/5	30
DP18074	7" Pizza Clamshell w/Window/Pad	7	7.84 x 7.60 x 1.75	3.26	20.77	--	250	6/5	30
DP1969	7" Pizza Clamshell w/Pad - Kraft	7	7.84 x 7.60 x 1.75	3.26	20.77	--	250	6/5	30
DP15583	8" Pizza Clamshell w/Pad - Fresh Hot	8	8.46 x 8.23 x 1.75	3.09	19.69	--	200	6/4	24
DP4991	9" Pizza Clamshell w/Pad - Kraft	9	10.13 x 9.60 x 1.75	3.68	35.10	--	150	6/4	24
DP5012	Calzone Clamshell - Kraft	7	9.07 x 5.36 x 3.05	3.44	29.03	--	350	4/6	24

### Dopaco Paper Triangular Slice Tray

Product Number	Description	Ounce Capacity	Dimensions (in inches)	Cube	Case		Packing		Cases/ Unit Load
					Approx Wt.	Sleeve	Case	Ti/Hi	
DP7857	Regular Slice Tray	80	6.26 x 7.5 x 0.98	0.56	17.27	--	1000	13/5	65

### ONEbox™ Paper Boxes

Item Number	Description	Dimensions (in inches)	Case Weight	Case Cube	Case Pack	Cases/ Unit Load
<b>White Boxes</b>						
SMB01WHT	White Fold Top Container	5 x 4 x 2.5	7.90	1.45	180	54
SMB02WHT	White Fold Top Container	8.5 x 6.25 x 1.9	10.40	2.60	140	28
SMB03WHT	White Fold Top Container	8.5 x 6.25 x 2.5	13.20	2.20	130	32
SMB04WHT	White Fold Top Container	8.5 x 6.25 x 3.25	11.40	2.01	90	28
SMB05WHT	White Fold Top Container	8.5 x 8.5 x 2.5	16.10	3.32	100	24
SMB08WHT	White Fold Top Container	6.75 x 5.5 x 2.5	9.40	1.70	130	45
<b>Black Boxes</b>						
SMB01BLK	Black Fold Top Container	5 x 4 x 2.5	7.90	1.45	180	54
SMB02BLK	Black Fold Top Container	8.5 x 6.25 x 1.9	10.40	2.60	140	28
SMB03BLK	Black Fold Top Container	8.5 x 6.25 x 2.5	13.20	2.20	130	32
SMB04BLK	Black Fold Top Container	8.5 x 6.25 x 3.25	11.40	2.01	90	28
SMB05BLK	Black Fold Top Container	8.5 x 8.5 x 2.5	16.10	3.32	100	24
SMB08BLK	Black Fold Top Container	6.75 x 5.5 x 2.5	9.40	1.70	130	45
<b>EarthChoice® Kraft Boxes</b>						
SMB01KEC	Kraft Fold Top Container	5 x 4 x 2.5	7.90	1.45	180	54
SMB02KEC	Kraft Fold Top Container	8.5 x 6.25 x 1.9	10.40	2.60	140	28
SMB03KEC	Kraft Fold Top Container	8.5 x 6.25 x 2.5	13.20	2.20	130	32
SMB04KEC	Kraft Fold Top Container	8.5 x 6.25 x 3.25	11.40	2.01	90	28
SMB05KEC	Kraft Fold Top Container	8.5 x 8.5 x 2.5	16.10	3.32	100	24
SMB08KEC	Kraft Fold Top Container	6.75 x 5.5 x 2.5	9.40	1.70	130	45

### EarthChoice® PLA Portion Cups & Lids

Product Number	Description	Ounce Capacity	Cube	Case		Packing		Cases/ Unit Load
				Approx Wt.	Sleeve	Case	Ti/Hi	
YSPLA-200EC	2 oz. Printed PLA Clear Portion Cup	2.0	1.44	15.55	12/200	2,400	36	
YSPLA-300EC	3.25 oz. Printed PLA Clear Portion Cup	3.25	2.06	23.10	12/200	2,400	27	
YSPLA-400EC	4 oz. Printed PLA Clear Portion Cup	4.0	2.06	25.05	12/200	2,400	27	
YLSPLA-2	2 oz. PLA Clear Portion Cup Lid	--	1.41	8.20	24/100	2,400	33	
YLSPLA-3	3.25 & 4 oz. PLA Clear Portion Cup Lid	--	1.94	10.75	20/120	2,400	27	

### EarthChoice® PLA Hinged & Deli Containers

Item#	Description	Capacity	Dimensions	Case		Case		Cases/ Unit Load
				Cube	Weight	Sleeve	Pack	
<b>Clear Hinged Lid Containers</b>								
YL18-1160-0000	EarthChoice® 6 in. Clear Hinged Container	20	5 3/4 x 6 x 3	3.33	22.80	4/125	500	16
YL18-1120-0000	EarthChoice® Medium 1-Cmpt. Clear Hinged Cont.	49	8 13/64 x 8 11/32 x 2 29/32	2.06	17.93	2/100	200	24
YL18-1123-0000	EarthChoice® Medium 3-Cmpt. Clear Hinged Cont.	5 (sm), 14 (lg)	8 13/64 x 8 11/32 x 2 29/32	2.06	17.93	2/100	200	24
<b>Clear Deli Containers &amp; Lids</b>								
YL18-6008-0000	EarthChoice® 8 oz. Clear Deli Container w/Lid	8	5.9 x 4.9 x 1.25	2.26	10.03	5/51	255	24
YL18-6016-0000	EarthChoice® 16 oz. Clear Deli Container w/Lid	16	5.9 x 4.9 x 2.75	2.56	11.82	5/51	255	24
YL18-6024-0000	EarthChoice® 24oz. Clear Deli Container w/Lid	24	7.5 x 6.5	2.68	10.73	2/100	200	18
YL18-6032-0000	EarthChoice® 32 oz. Clear Deli Container w/Lid	32	7.5 x 6.5 x 2.70	2.93	13.85	4/50	200	18

**Hinged Lid Deli Containers – RPET**

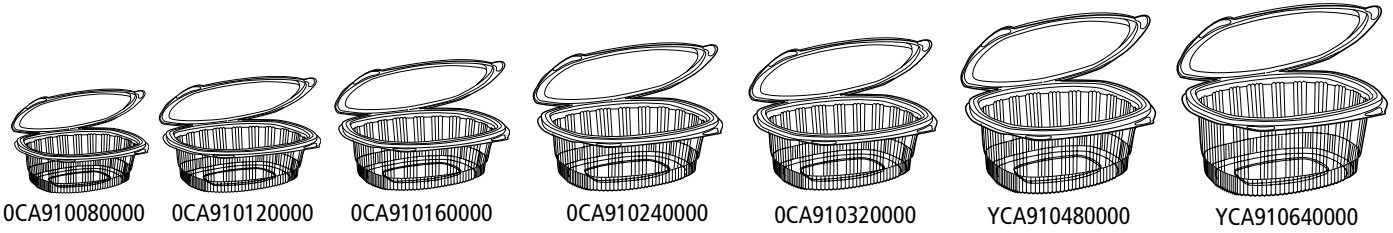

**Grandstand™ Hinged Bowls - PETE**



**Reynolds® Sho-Bowls® - PETE**

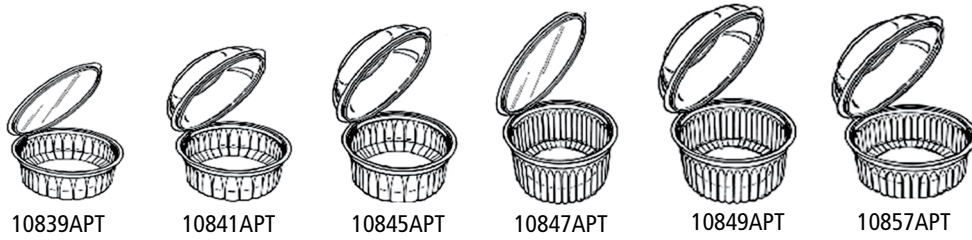

## Hinged Lid Deli Containers – RPET

Product Number	Description	Case Dimensions (in inches)	Case Cube	Case Approx. Wt.	Case Sleeve	Case Pack	Cases/ Unit Load
<b>RPET Hinged Lid Deli Containers</b>							
OCA910080000	8 oz. Clear Hinged Container	4.92 x 5.87 x 1.32	2.40	10.30	1/200	200	48
OCA910120000	12 oz. Clear Hinged Container	4.92 x 5.87 x 1.89	2.40	10.94	1/200	200	48
OCA910160000	16 oz. Clear Hinged Container	4.92 x 5.87 x 2.48	2.40	11.09	2/100	200	48
OCA910240000	24 oz. Clear Hinged Container	6.00 x 7.28 x 2.28	3.66	16.76	1/200	200	27
OCA910320000	32 oz. Clear Hinged Container	6.00 x 7.28 x 2.99	3.66	17.16	2/100	200	27
YCA910480000	48 oz. Clear Hinged Container	7.35 x 8.96 x 2.86	4.12	23.39	2/95	195	24
YCA910640000	64 oz. Clear Hinged Container	7.35 x 8.96 x 3.72	4.12	22.60	2/95	195	24

## Grandstand™ Hinged Bowls - PETE

Product Number	Description	Outside Dimensions (in inches)	Case Cube	Case Weight	Case Pack
12761	18 oz. Clear Hinged Lid w/Black Base Bowl	7 1/4 x 2 3/4 x 1 3/4	2.80	14.00	150
12807	18 oz. Clear Hinged Bowl	7 1/4 x 2 3/4 x 1 3/4	2.82	13.00	150
12808	28 oz. Clear Hinged Bowl	7 1/4 x 3 1/2 x 2 1/2	2.83	13.00	150
12809	35 oz. Clear Hinged Bowl	7 1/4 x 4 x 3	2.82	13.65	150
12811	54 oz. Clear Hinged Bowl	8 x 4 3/8 x 3 1/4	3.58	16.00	130

## Reynolds® Sho-Bowls® - PETE

Product Number	Description	Color	Dimensions (in inches)		Vert. Depth	Case Cube	Case Weight	Case Pack	Cases/ Unit Load
			Top Out	Base Height					
10839APT	8 oz. Bowl w/Flat Lid	Clear	4 5/8	1 1/4	1 3/4	2.71	8.65	250	40
10841APT	8 oz. Bowl w/Dome Lid	Clear	4 5/8	1 1/4	2 3/4	2.58	8.00	250	40
10845APT	12 oz. Bowl w/Dome Lid	Clear	4 5/8	1 3/4	3 3/8	2.62	10.00	250	40
10847APT	16 oz. Bowl w/Flat Lid	Clear	4 5/8	2 1/2	3	2.62	11.00	250	40
10849APT	16 oz. Bowl w/Dome Lid	Clear	4 5/8	2 1/2	4 1/4	2.54	11.00	250	40
10857APT	16 oz. Bowl w/Dome Lid	Clear	6 7/8	1	2 3/4	2.88	10.00	150	35
10863APT	32 oz. Bowl w/Flat Lid	Clear	6 7/8	2 1/4	2 3/4	2.82	12.00	150	35
10865APT	32 oz. Bowl w/Dome Lid	Clear	6 7/8	2 1/4	4 1/8	2.75	12.00	150	35
10869APT	39 oz. Bowl w/Dome Lid	Clear	6 7/8	2 3/4	4 1/2	2.82	14.10	150	35
10853APT	56 oz. Bowl w/Ribbed Dome Lid	Clear	7 1/2	2 1/4	4 7/8	3.54	17.00	150	30
10851APT	56 oz. Bowl w/Flat Lid	Clear	7 1/2	3 1/8	3 5/8	3.43	16.00	150	30





